



The maritime cluster in the Baltic Sea region and beyond

Edited by Kari Liuhto

BSR Policy Briefing 1/2016

The maritime cluster in the Baltic Sea region and beyond

Edited by Kari Liuhto

Contents

Authors	1
Introduction Kari Liuhto	10
EU support to unlocking blue growth opportunities João Aguiar Machado	14
Evolution of the maritime cluster in a changing world Tuomas Routa	17
The Finnish maritime cluster co-operates for growth Merja Salmi-Lindgren, Janne Peltola, Ulla Tapaninen, Juha Valtanen, Olof Widén, Elina Vähäheikkilä, Pekka Rouhiainen, Pekka Pokela, Mervi Pitkänen, Arto Alho, Pentti Häkkinen and Sari Repka	19
Maritime transport in the Baltic Sea in 2016 Lauri Ojala	38
Sea transport capacity of Finland Bo Österlund	50
Shipping and environmental governance in the Baltic Sea region Daria Gritsenko	68
From tanker safety to ENSI service Mikko Klang and Pekka Laaksonen	81
Passenger shipping on the Baltic Sea Luulea Lääne	90
Arctic shipping – Has it been put on Ice ? Felix H. Tschudi	95

Icepool – Holistic use of global icebreaker fleet Tero Vauraste	104
Shipbuilding industry in the Baltic Sea region Kaidi Nõmmela and Alari Purju	106
Arctic shipbuilding – Case: Arctech Helsinki Shipyard Esko Mustamäki	126
Delivering sustainable and energy-efficient cruise ships Jaana Hänninen, Tero Mäki-Jouppila and Kari Sillanpää	131
Environmental efficiency – Now! Text by Wärtsilä, edited by Aslak Suopanki	137
Russian innovative companies in marine engineering – Case: Seismo-Shelf Ltd Nikita Lisitsyn	141
Baltic Sea ports – A recent picture and an overview of selected challenges Bogdan Ołdakowski	146
Russian foreign trade flows and Eastern Baltic Sea seaports Elena Efimova and Sergei Sutyrin	161
The Port creates opportunities Christian Ramberg	170
The Port of Ust-Luga – New window to Europe Oleg Dekhtyar	174
Maritime cargo traffic in the framework of transforming transport corridors – Can scenario-building bring clarity? Erik Terk and Alari Purju	178
Baltic Sea 2030 – Trends and scenarios Heikki Liimatainen	189

Authors



João Aguiar Machado, Director-General at the European Commission's Directorate-General for Maritime Affairs and Fisheries. J. Aguiar Machado is in charge of implementing the new Common Fisheries Policy and to secure sustainable fisheries, a stable supply of seafood for EU market and also prosperous coastal communities. As the DG in charge of Maritime Policy, his mission is also to promote an integrated approach to all maritime policies. Before taking his current position, he was Director-General at the European Commission's Directorate-General for Mobility and Transport. Previously Mr Aguiar Machado worked mostly on trade matters and international relations, namely as Deputy Director-General for Trade and Deputy Director-General for External Relations. Mr Aguiar Machado studied economics in Lisbon and Bruges.



Arto Alho is Project Manager for the FinBraTech project in Brazil. Before this position, he has had various positions in different industry segments both in Finland and Brazil. He has experience from management of subsidiaries in both countries, sales of large investment projects, marine and offshore engineering services, engineering industry, as well as welding and material technology.



Oleg Dekhtyar, Capt., graduated from the Navigational Faculty of the Leningrad Higher Marine Engineering College in 1984. In 1984-2001, Dekhtyar worked as Deck Officer and Captain on the ships of Murmansk Shipping Company. During 2001-2013, he was in various top management positions of several shipping companies. Since 2013, Oleg Dekhtyar has acted as Deputy General Director of JSC Commercial Sea Port of Ust-Luga.



Elena Efimova is Professor of St. Petersburg State University. Her main research interests are regional economics and industrial organisation with a special focus on the transport infrastructure and international traffics and logistics. Currently, her recent researches include statistical analysis of the activities of the Baltic Sea ports, economic growth in large and small scales countries.



Daria Gritsenko, D.Soc.Sc., is specialising in the field of public policy, with a special focus on dynamics of regulatory governance in shipping and energy sectors. She has published in international journals on the subject of environmental quality governance in shipping, energy infrastructure development, and transformation of socio-technical systems. Currently, she is a postdoctoral fellow at the Aleksanteri Institute (the University of Helsinki) conducting research on environmental dimensions of the Arctic energy development and transportation, and a partner at the Finnish Centre of Excellence "Choices of Russian Modernization".

BSR Policy Briefing 1/2016



Pentti Häkkinen is currently the programme director of the Turku Seas 2020, part of actions for fostering of the Finnish maritime industry established by the Ministry of Employment and the Economy. Pentti Häkkinen graduated from the Helsinki University of Technology. He has an M.Sc. in Engineering, and from 1970 onwards, he has worked in several positions within Wärtsilä Turku Shipyards and Wärtsilä Diesel. In 1989-2009, Häkkinen held the Marine Engineering professor chair at the Helsinki University of Technology Ship laboratory. His published works cover a wide range, and they include, for instance, four university textbooks on marine engineering systems. Between 2009 and 2012, Pentti Häkkinen worked as the head of the Ship laboratory at the Turku University of Applied Sciences. During his time at the university, he has contributed in numerous projects in technical research and industrial operations.



Jaana Hänninen is Environmental Manager at the Meyer Turku shipyard. She has 10 years of experience of various environmental issues in the maritime sector regarding e.g. Corporate Social Responsibility, vessels cradle-to-cradle-thinking, ship recycling and Greenpassport as well as the shipbuilding process. She is also the Project Manager of SUSTIS (Sustainability Transparency in Shipbuilding Networks), which concentrates on new value-creating business models, creating more transparent and reliable networks and establishing calculation models to evaluate sustainability.



Mikko Klang is Project Manager at John Nurminen Foundation, the goal of which is to work for the benefit of the Baltic Sea delivering greatest possible impact with the resources in use. With the background of Master Mariner working onboard oil tankers and developing navigational guidelines at the office, he has been focusing on implementing the ENSI service since 2012, first at the Foundation and later as a consultant at the Finnish Transport Agency.



Pekka Laaksonen is Senior Advisor at John Nurminen Foundation, the goal of which is to work for the benefit of the Baltic Sea delivering greatest possible impact with the resources in use. With the background of almost 30-year experience in global telecommunications industry, he was in charge of the Tanker Safety project at John Nurminen foundation.

Heikki Liimatainen leads the Transport Research Centre Verne at the Tampere University of Technology. He graduated as a Master of Science in 2008 and Doctor of Science in Technology in 2013. Liimatainen has worked at the Tampere University of Technology since 2005 and visited the Logistics Research Centre at the Heriot-Watt University, Edinburgh, in 2009-2010. Liimatainen has been the transport expert in the Finnish Climate Panel since 2014. In February 2016, he was appointed as Assistant Professor of transport systems with a special focus on transport transformation.



BSR Policy Briefing 1/2016



Nikita Lisitsyn received his Ph.D. from the St. Petersburg State University, Russia in a field of World Economy in 2004. Lisitsyn worked as Assistant in 2000-2005 and as Associate Professor in 2005-2013 at the St. Petersburg State University, the Department of World Economy. He has been involved in several research projects with the Turku School of Economics and the Helsinki School of Economics, Finland. In 2006, he acted as a visiting researcher at the Turku School of Economics, investigating innovation system of Russia and the role of scientific parks. In 2009, Lisitsyn became a co-founder of Seismo-Shelf Ltd., a Russian innovative company in marine engineering and sea exploration. In 2012, he was elected as CEO of Seismo-Shelf Ltd., and in 2015 he was re-elected to this position again. Nikita Lisitsyn still acts as a visiting lecturer at the University of Turku and the St. Petersburg State University.



Kari Liuhto has received his Ph.D. (Social Sciences) from the University of Glasgow and the degree of Doctor of Science (Economics) from the Turku School of Economics. Liuhto was appointed as Professor at the Department of Industrial Engineering and Management, Lappeenranta University of Technology in 1997. In 2003, Liuhto was invited to hold a tenure professorship in International Business at the Turku School of Economics, the University of Turku. In addition to the professorship, Liuhto is Director of the Pan-European Institute and Director of Centrum Balticum Foundation. Liuhto's research interests include foreign direct investment, international energy business, the Russian economy and regional development in the Baltic Sea region. Professor Liuhto has been involved in several projects funded by the European Commission, the European Parliament, the United Nations and various Finnish ministries.



Luulea Lääne has been working as the Communication Director of AS Tallink Grupp since December 2006, leading the Company's everyday communication management, including corporate communications, marketing and crises communications, issue management and investor related communications. Before joining Tallink, she worked for one of the leading PR agencies in Estonia, AS Corpore as consultant, advising many private and public organisations, among them Saaremaa Shipping Company, AS Tallink Grupp, sports organisations, such as Estonian Equestrian and Sailing Federations, and international consumer brands. She has graduated from the Tartu University and is a member of the European Association of Communication Directors having served 2 terms as a Board Member and years as the Regional Co-ordinator for Baltic States area.



Esko Mustamäki is CEO of Arctech Helsinki Shipyard Inc. Esko Mustamäki graduated from the Helsinki University of Technology in 1984 with M.Sc. in Engineering and he has held several management level positions within the maritime sector. He started his carrier at Wärtsilä Marine in 1980 where he held several positions within Arctic research and shipbuilding. In 1990, he joined FG-Shipping Ltd, where he became CEO 1996, which position he held until the merger with Finnlines Plc year 2000. In 2004, he was appointed to CEO for Finstaship and since April 2011 he has been the CEO for Arctech Helsinki Shipyard Inc.

BSR Policy Briefing 1/2016



Tero Mäki-Jouppila is Energy Efficiency Coordinator at the Meyer Turku shipyard's Sales & Design department and responsible for the ship's overall energy efficiency development in concept and new building projects as well as in retrofit projects. He has 10 years of experience in the maritime sector and last seven years mainly focusing on vessel's overall energy efficiency R&D work. He is currently also working on his master thesis in which he investigates LNG's (Liquefied Natural Gas) selection of primary fuel impact to cruise ship's energy efficiency and exhaust gas emissions.



Kaidi Nõmmela is a Ph.D. student of the Department of Logistics and Transport at the Tallinn University of Technology (TUT). The theme of her doctoral thesis is development dynamics and functioning regularities of the Estonian Maritime Cluster. She holds master's degrees in maritime studies and in international relations and European-Asian studies. She has been researching economic changes in Estonian maritime sector, clustering and competitiveness theories, operational challenges in port sector and transport chains and international co-operation in maritime business sector. She has been researcher and co-ordinator of several national and international studies.



Lauri Ojala is Professor of Logistics at the Turku School of Economics (the University of Turku) since 1997. His research interests include Trade and Transport Facilitation (TTF), international logistics and Supply Chain Management (SCM), and transport markets also from a policy-making perspective. Worked as TTF expert for e.g. The World Bank, ADB, NIB and UNIDO. Initiator and co-author of Logistics Performance Index by The World Bank (<http://lpi.worldbank.org/>), published since 2007, with the LPI 2016 coming out in May 2016. Headed six "Finland State of Logistics" surveys in 2006-2016, which comprise the largest national database of its kind in the world.

Since 2006, Project Director of several large EU part-funded logistics projects with a combined volume of 12+ M€. The latest of these is "HAZARD" on Baltic Sea Region port safety & security in 2016-2019. Numerous publications and articles in about 20 high-ranking refereed journals in the field.

Bogdan Ołdakowski, BPO Secretary General and CEO of Actia Forum Ltd, has acted as Secretary General of the Baltic Ports Organization since July 2006. He is also the founder and co-owner of Actia Forum Ltd established in 2000. In 2003-1996, he worked in various positions in the Port of Gdańsk Authority Co. At the same time, he was a chairman of the Environment Committee of the Baltic Ports Organization. Ołdakowski has been involved in work of several international transport-related organisations, such as European Sea Ports Organization, and International Maritime Organization. He has been organiser, chairman and speaker in many international conferences. Ołdakowski graduated in 1993 from the University of Gdansk, the Faculty of Physical Oceanography. He has also finished post-graduate studies on Law and Management at the Gdańsk University of Technology. He has participated in professional trainings on management, transport, environment, and international relation affairs. His hobby are sports (tennis, football, skiing), jazz, and contemporary art.



BSR Policy Briefing 1/2016



Janne Peltola works as a Ministerial Adviser in the office of the Permanent Secretary of the Ministry of Employment and the Economy. He has been working in the ministry since 2009. In addition to assisting the Permanent Secretary in industrial policy issues, Peltola is responsible for co-ordinating the entire marine industry. He also deals with Arctic-related issues in the ministry. He is, for instance, a member of the steering group of Tekes' Arctic Seas programme as well as the Arctic Advisory Board appointed by the Prime Minister's Office. Within his duties, Janne Peltola takes part in national, EU and international policy in covering marine industry and Arctic issues.

Mervi Pitkänen is a director for the Maritime Industry development at the Machine Technology Center Turku Ltd. She holds the Master of Science degree in Naval Architecture (major subject) and Industrial Economics (minor subject) from the Helsinki University of Technology with additional Industrial design studies at the Helsinki School of Arts. The Maritime Industry development activities are carried out by the Trimmi Project funded by the Ministry of Employment and the Economy. 2007-2013, she was the national co-ordinator for the Finnish Maritime Cluster Programme (OSKE) under the authority of the Ministry of Employment and the Economy. She has over 12 years' worth of experience in leading and managing R&D departments, portfolios and projects in maritime industries. She is also a member of the steering group at Tekes – the Finnish Funding Agency for Innovation's Arctic Seas programme.



Pekka Pokela, D.Sc. (Tech.), is Business Director at Gaia Consulting Ltd and has executed several demanding strategy processes with industrial organisations, key innovative organisations and operators in the public sector. He specialises in building strategic business networks and facilitating network co-operation. He has executed several demanding development projects in areas of business, technology, export industry, strategic sales and business networking. Pokela is exceptionally familiar with the Arctic market and the international businesses operating in the field. He has

diverse links to the Ministry for Foreign Affairs of Finland, the embassy network of various countries, top business executives, along with universities and research institutes in the important key areas of the technology industry in particular. He received his doctorate in 1991 from the Helsinki University of Technology after working in research projects funded by Digital Equipment Corporation and Intel Corporation at the California Institute of Technology in the USA.



Alari Purju is a Head of Department of Logistics and Transport at the Tallinn University of Technology (TUT). He has been working as Dean of the Faculty of Economics and Business Administration of the TUT, as an advisor to the Minister of Economic Affairs of Estonia. He has been also a consultant for the World Bank (The Commission for Growth and Development), the OECD, the EU Commission, participated in evaluation of Latvian higher education institutions as a consultant hired by the European Social Fund project. Professor Purju holds Ph.D. from the Institute of Economics of the Academy of Science of Estonia and M.A. in Economics from the New York State University in Albany and the Central European University.

BSR Policy Briefing 1/2016

Christian G. S. Ramberg has been Managing Director at the Port of Turku since 2000. Education: Master of Economic Sciences at The School of Economics and Business at the Åbo Akademi University in 1983. Mr Ramberg has 30 years of working experience within the Finnish transport and logistics industry. He is a member of and involved in several business and logistic organisations in Finland, such as the Finnish Port Association, the Turku Chamber of Commerce, the World Trade Center Turku, and the Turku University Centre of Maritime Studies. Mr Ramberg is also a member in maritime-related projects, such as ESPO Intermodal, Logistics & Industry Committee and Scandinavian-Mediterranean Core Network Corridor Forum.

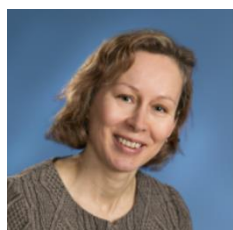

Sari Repka, Dr., Head of Unit, has worked 6 years at the University of Turku, the Brahea Centre CMS studying environmental effects of maritime traffic, concentrating mainly on exhaust gas emissions and the cost-effectiveness of environmental regulation. A novel study interest of hers is the maritime spatial planning, and in it especially balancing of the environmental effects and regional development of human activities on sea. In addition, she has approximately 15 years' worth of experience on marine environmental research, and she has worked at the University of Helsinki, the Nessling Foundation and the Netherlands Institute of Ecology. She defended her thesis at the University of Amsterdam.



Pekka Rouhiainen, the Chief Adviser, D.Sc. (Tech.), Prizztech Oy. Rouhiainen has more than 35 years of experience working in oil and gas offshore operations and the marine industry in Finland, the USA, Russia and Canada. His core competences are Business Development, Project Management, Construction Management and Leading New Product Development. He is currently Project Manager of a project promoting the exports of the Finnish SMEs in Norway and Russia funded by the Ministry of Employment and the Economy and the City of Pori. Prior to his current responsibilities, Mr Rouhiainen has worked in different managerial positions for companies, such as Kvaerner, Technip, Aker Maritime and Rauma-Repola. In 2016, he is chairing the Finnish Marine Industries Offshore Work Group.



Tuomas Routa has studied naval architecture and marine engineering in the Helsinki University of Technology and obtained a Master of Science degree in 1983. During his career, Mr Routa has worked over 14 years in various positions in the shipbuilding industry, covering R&D, project design, and sales and marketing. He was also a member of the management committee at Aker Yards Turku Shipyard. In addition to the positions in shipbuilding industry, Mr Routa has worked in shipping companies, where he has held various senior management positions for a period of about 10 years. Mr Routa joined the Finnish Maritime Administration in September 2008 as Director of Maritime Safety. Today, Mr Routa holds the position of Director General of Maritime Sector at the Finnish Transport Safety Agency.

BSR Policy Briefing 1/2016



Merja Salmi-Lindgren, Secretary General of the Finnish Marine Industries, has gathered extensive experience in the field of the maritime cluster, as well as industrial and economic policy issues. She promotes the entire Finnish Marine Technology sector in international organisations, such as SEA EUROPE. Prior to her current responsibilities, she worked in Aker Finnyard's shipbuilding company in various positions, and before that in the international consulting and engineering company Pöyry Group. Altogether, she has over 20 years of professional experience. She is a member of the Finnish Arctic Advisory Board, a member of TEKES's (the Finnish Funding Agency for Innovation) Arctic Seas Steering Group, as well as a member of the Finnish Maritime Advisory Board.



Kari Sillanpää is Head of Research and Development at the Meyer Turku shipyard. He has long experience in shipbuilding and comprehensive knowledge of different ship types and shipping. Currently, he is leading the product and markets related research and development functions. He has been involved in concepting and designing of tens of new cruise ships and passenger ferries with specialties in concept development, customer-oriented approach, energy efficiency, sustainability, and research co-operation.



Aslak Suopanki, M.Sc. in Chemistry, works as Senior Technical Manager in Environmental Solutions of Wärtsilä Marine Solutions. He has almost two decades of R&D and technical experience in the environmental business for a wide range of applications, from automotive to ships and stationary. He joined Wärtsilä in 2007 and is currently mainly focusing on SO_x scrubbers for existing vessels.



Sergei Sutyryn is Professor and World Economy Department Head at St. Petersburg State University (SPSU), WTO chair holder since 2010. In addition to his professorship at SPSU, Sutyryn has delivered lectures in several universities in Finland, Germany and Japan. Research interests of Sutyryn include Russian foreign economic relations, international trading system and global governance. He is an author of more than 200 books, pamphlets and articles in different fields of economic theory. Sutyryn has been involved in many research and educational projects funded in particular by the EU, DAAD, CIDA, and International Trading Center.

Ulla Tapaninen, Adjunct Professor, Ph.D., has over 20 years' worth of experience in logistics and maritime transport research and development work. She has worked in shipping companies, universities and public administration as an environmental manager and a professor in maritime logistics. Currently, she works as Senior Specialist for the City of Helsinki in port and cross-border transport development projects. She is also in charge of the Helsinki City maritime cluster programme, focusing on the city's unique Arctic and smart marine industry. Dr. Tapaninen has published dozens of academic and professional publications and she is a frequent speaker in seminars. In 2013, she published a Finnish textbook the Maritime Logistics presenting the fundamentals of maritime business.



BSR Policy Briefing 1/2016

Erik Terk, Dr., has long experience in initiating and carrying out futures-related research in Estonia. He acted as Deputy Minister of Economic Affairs in the first Estonian Government after Estonia re-gained her independence. Terk has worked permanently as a consultant for private and public organisations, including organisations in the field of transport and logistics. Currently, Erik Terk is Professor of Futures Studies and Strategic Management and Project Director for globalisation networks and foresight related projects in the Tallinn University.



Felix H. Tschudi is the Chairman and owner of the Tschudi Group (www.tschudishipping.com), a shipping, offshore and logistics group with main geographical focus on cargo flows between North-West Europe, Russia and the Central Asian Republics including logistics in the Arctic. Mr Tschudi attended the Royal Norwegian Naval Academy and served as Sub-Lieutenant in the Royal Norwegian Navy. He earned a Second Mate's certificate from merchant navy colleges in the UK, a B.Sc. (Econ) from London School of Economics and an MBA from INSEAD, France. Before joining the family shipping company, Tschudi & Eitzen, in 1989, Felix specialised in trade finance with Eastern Europe and the former Soviet Union. Felix H. Tschudi is the Chairman of the Centre for High North Logistics, a non-profit research foundation focusing on transportation solutions in the Arctic. He is also a member of the World Economic Forum's Global Agenda Council on the Arctic, the Committee of the P&I Club Skuld, the board of the Norwegian publishing house Aschehoug & Co and a former president of the Oslo Shipowners Association and Maritime Offshore Forum Oslofjord.



Juha Valtanen is Manager at Machine Technology Center Turku Ltd. He possesses a wide range of experience and expertise in co-ordinating the long-term development activities of the maritime sector, EU project management and in facilitating co-operation between the marine industry and educational institutions. Valtanen has a Master's Degree in Economics and Financial Management.



Tero Vauraste, 48, is President and CEO of Arctia Ltd, a Finnish Polar Maritime Services company. The company provides icebreaking, ice management, oil spill response and other polar maritime services with a fleet of 8 icebreakers and 300 professionals. He holds an M.Sc. in Risk, Crisis and Disaster Management from Leicester University. He is a former Naval officer (Lieutenant-Commander) and he has served as a vessel master and in several other positions in Finnish Coast Guard: He has worked in several executive positions within the traffic service cluster, including security and safety, aviation and car rental. He is Vice Chair of the Arctic Economic Council. He is a member of the Board of Finnish Arctic Society and Finnish Maritime Society likewise a member of Advisory Board of Finnish Lifeboat Institution.

BSR Policy Briefing 1/2016



Elina Vähäheikkilä, M.Sc. in Industrial Engineering and Management, works as Project Manager in the Finnish Marine Industries, a branch association of the Finnish Technology Industries. Vähäheikkilä is executing the "Project on Marine Market Forecasting" in the Ministry of Employment and Economy's Meri-programme. The aim of the project is to collect, analyse and share market information for the Finnish Maritime Cluster. She is also responsible for co-ordination of the Research Committee of marine cluster and international research co-operation within the branch. Vähäheikkilä joined the Finnish Marine Industries in 2013, after working in shipbuilding.



Olof Widén started his seaman's career in 1976 on the s/s Turku. Widén commenced his studies in the Turku Sea Academy in 1981 and received watch-keeping officer's license in 1983. He served two years as a mate on cargo vessels in the European trade. In 1985, Widén continued his studies in the Mariehamn Sea Academy, from which he graduated in 1987 with captain's license. He continued working on board cargo- and passenger vessels in the European trade. In 1990, he accepted a shore-based employment as an advisor in the Cargo-ships Association. Eighteen years later in June 2008 when the three ship-owners associations in Finland merged into one, Widén became one of three vice-presidents. In 2009, Mr Widén was appointed as the managing director of the Finnish Shipowners' Association. Nowadays, he is also a board member of the European Community Shipowners' Associations ECSA and the International Chamber of Shipping ICS.



Bo Österlund, Commodore (ret), retired from the Finnish Defence Forces in 2006. He ended his active career as Commanding Officer of the Military District of Turku and Pori. Österlund's research interests focus on the changes in the Baltic security policy. In recent years, his particular interest has targeted at the security of energy and maintenance activities, as well as of the sea traffic in the Baltic Sea region in general. Österlund has participated in several preparative security projects concerning sea traffic, maritime transports, and harbours. In 2014, Österlund wrote a report (Meriliikenteen huoltovarmuusselvitys 2014) concerning sea transport security of supply for Finland's National Emergency Supply Agency (NESA). Based on this report, he is currently preparing his doctoral thesis that will examine the achievement of the targets set for the security of supply of Finnish shipping.

Introduction

Kari Liuhto

The countries surrounding the Baltic Sea differ from each other so much geographically, culturally and politically that if the sea did not connect them we would hardly refer to them as the Baltic Sea region. It is also unlikely that, without the Baltic Sea, the European Union would have drafted a regional strategy for this area. Another body of water – the Danube, which is almost 3,000 km long – links up the second macro-region in the EU.

However, seas and rivers do not automatically unite nations. A look at a map of Europe will show that, in addition to mountains, bodies of water are the most common natural boundaries between countries. Seas, rivers and other bodies of water serve as connecting routes only to those who are able to use them. As a functional maritime cluster enables people to use bodies of water for transportation, the maritime cluster is in the epicentre for European integration and globalisation.

As a factor enabling integration, the maritime cluster naturally has a considerable economic significance to the European Union. According to a report by the European Commission¹, European ports handle nearly 25% of the world's seaborne trade and European ship owners control almost 40% of the world marine fleet. João Aguiar Machado, Director-General for Maritime Affairs and Fisheries, writes in his article that the blue economy industries account for 3-5% of the EU's economy. Correspondingly, a large expert team led by Merja Salmi-Lindgren, Secretary General of the Finnish Marine Industries, analyses Finland's maritime cluster and states that this cluster employs 2% of the total Finnish workforce and accounts for 4% of the total output of Finland.

Despite the importance of the maritime cluster, Esko Mustamäki, CEO of Arctech Helsinki Shipyard, notes that European shipbuilding has seen a dramatic decrease in the past decades. Today, Asia accounts for more than 90% of the global shipbuilding volume. Those shipyards that have survived in Europe are highly specialised. Mustamäki believes that Arctic specialisation will keep Arctech Helsinki Shipyard alive in the face of harsh global competition. Felix H. Tschudi, Chairman of the Board of Directors of Tschudi Group, also believes in Arctic possibilities, as the Northeast Passage shortens the distance between the Atlantic Ocean and the Pacific Ocean by 40-60%. If there is an increase in the volume of maritime transportation through the Northeast Passage, new icebreakers will be required and the existing ones must be used more efficiently. Tero Vauraste, CEO of Arctia, addresses this issue by proposing the foundation of "Icepool", an icebreaker leasing system, as an economically feasible way to keep the maritime routes open all year round.

Kaidi Nõmmela and Alari Purju from Tallinn University of Technology reveal several stunning facts concerning the maritime sector of the Baltic Sea region in their article, such as that the Helsinki shipyard (currently Arctech Helsinki Shipyard) has constructed 60% of the world's icebreakers, the Norwegian offshore industry is the second largest in the world after that of the USA, Russia's North-West district

¹ European Commission (2008) The role of Maritime Clusters to enhance the strength and development of European maritime sectors.

accounts for over 70% of the country's total shipbuilding production, private Russian ship owners order a mere 6% of their ships from Russian shipyards, and Meyer Werft contributes to up to 70% of the total shipbuilding in Germany. Jaana Hänninen, Tero Mäki-Jouppila and Kari Sillanpää from the Meyer Turku shipyard write about sustainable and energy-efficient cruise ships. Aslak Suopanki from Wärtsilä writes on a similar theme, focusing on Wärtsilä and its environmental solutions for the marine industry. As an example, he mentions scrubbers, which the company has been developing for almost 10 years.

The Baltic Sea is one of the world's busiest shipping routes with approximately 2,000 vessels at sea at any time – for this reason, well-run maritime logistics are vital, particularly to countries in the north of the Baltic Sea region. Bo Österlund, a retired Finnish commodore, notes in his study that the Nordic countries on average import 7.9 tonnes of goods per capita by sea on an annual basis, while Japan imports 7.5 tonnes per capita per year. On the basis of these statistics, it would not be an exaggeration to call the Nordic countries the EU's "*largest island*".

As over 300 million tonnes of crude oil and oil products are transported via the Baltic Sea annually, we need to pay close attention to the safety of these shipments. Klang and Laaksonen start their article by examining a notorious case in which a navigation error led an oil tanker to run aground on a shoal in the Gulf of Finland in 2007. The vessel's cargo consisted of 100,000 tonnes of crude oil, but thanks to the double-hull structure of the ship, none of it spilled into the sea. Inspired by this case, the John Nurminen Foundation developed the Enhanced Navigation Support Information (ENSI) system. Daria Gritsenko, a researcher at the University of Helsinki, observes in her article that over 10% of maritime accidents reported during 2006-2013 involved an oil tanker. Therefore, instead of wondering whether an oil accident could occur in the Baltic Sea, we should be asking ourselves: when, where and what then? Are the littoral states of the Baltic Sea well prepared enough to deal with an oil accident?

In addition to cargo transport, one should not forget about passenger transportation in the Baltic Sea. Luulea Lääne, Communication Director of AS Tallink Grupp, discusses the passenger transportation of TallinkSilja in her article. Lääne reminds us that the company has increased its passenger volumes from 160,000 people in 1990 to almost 9 million in 2015. It is noteworthy that the Chinese were the fourth largest nationality on board the company's ships in July 2015.

Bogdan Ołdakowski, Secretary General of the Baltic Ports Organization, writes that the total cargo volume in 2014 in Baltic Sea ports rose to 870 million tonnes, a 3.4% year-on-year increase. Russia's five Baltic Sea harbours handled altogether 24% of the Baltic Sea total. Even though Russia's share in the foreign trade of the Baltic States and Finland is relatively high (8-15%) and Russia's foreign trade dropped nearly 40% between 2013 and 2015, Elena Efimova and Sergei Sutyryn, professors at Saint Petersburg University, note that seaports of the Baltic States and Finland have in most cases managed to avoid a dramatic contraction in their activity in the period 2012-2014. It remains to be seen what the future brings.

In his article, Christian Ramberg, Managing Director of the Port of Turku, describes the contemporary activities of perhaps the most historic seaport of Finland. Oleg Dekhtyar, Deputy Director General of the Port of Ust-Luga, writes about one of the fastest-growing ports in the Baltic Sea region, namely Ust-Luga. The total turnover of this relatively new Russian port reached nearly 90 million tonnes in 2015, a 16% increase compared to the year 2014. Erik Terk, Professor at Tallinn University, and Alari Purju, Professor at Tallinn University of Technology, predict the future dynamics of the Helsinki-Tallinn maritime cargo traffic and assess the possibilities of the Port of Tallinn becoming a significant international cargo hub.

BSR Policy Briefing 1/2016

Their article implicitly indicates that transit volumes and transit routes between Western Europe and Russia may experience considerable changes in the foreseeable future.

More than 80% of Finnish foreign trade is handled by sea. As Finnish-owned vessels account for only a third of Finland's maritime traffic, it is no surprise that Commodore (ret.) Bo Österlund emphasises the importance of supply security and national ownership in his article. Finnish vessels accounted for just about a third of the total amount of goods transported by sea in 2014. Österlund estimates that a disruption in seaborne trade would cause Finland's energy production to be interrupted in 2-3 days. In the food industry, the time window ranges from 2-3 days to 2-3 weeks. These calculations indicate that it is not easy to maintain the national supply security of a country that is a small actor in the global production network.

Lauri Ojala, Professor at the University of Turku, stresses that the maritime transport sector in the Baltic Sea region has recently been and will be subject to substantial regulatory changes that mainly have environmental goals. He concludes that the cash-strapped shipping companies in the Baltic Sea region are not well prepared for these continuous changes, and therefore the next few years will not be easy for the maritime industry of the Baltic Sea region. Tuomas Routa, Director General of Maritime Sector at the Finnish Transport Safety Agency, incisively notes in his contribution: *"The world is permanently in change, and thus we need to be prepared for the future or at least to adopt our doings to these changes to survive"*.

It is not easy to predict future development. That said, examining alternative scenarios can shed light on the future. Heikki Liimatainen from Tampere University of Technology develops four future scenarios for the Baltic Sea until 2030. He names them: 1) the age of growth, 2) the age of regulation, 3) the age of locality, and 4) the age of change. It remains to be seen which of these four paths will materialise in the future – or if the future will surprise us once again. On the other hand, we may change the course of the future if we take change into our own hands.

Frozen relations between the West and Russia have affected the maritime cluster in the Baltic Sea region as well. Nikita Lisitsyn, CEO of Seismo-Shelf, describes a rather unexpected development in his article. This Russian company's domestic markets have expanded due to Western sanctions and the devaluation of the Russian Rouble, as its Western competitors have been forced to retreat from the Russian market. Intellectually, he concludes that this phenomenon of quasi-protectionism could be good for the Russian economy in the medium run, but would create a *"greenhouse effect"* for Russian producers of specialised marine equipment in the long term, leading to low effectiveness and non-competitiveness among Russian producers.

Relations between the EU and Russia are currently chilly. In many speeches, statesmen have expressed fears of a return of the Cold War. To prevent a new Cold War in the Baltic Sea region, we must do our utmost to ensure that in the future the Baltic Sea will serve more as a connecting highway than a border fence. We need political icebreakers and innovative solutions to break the ice of our mutual lack of trust to avoid giving the Cold War a foothold in our shared Europe. Arctic maritime co-operation could serve as one example of a political icebreaker – Arctic co-operation could yield the kind of results that no nation can achieve on its own.

In times of increasing uncertainty, the importance of dialogue and the ability to make even non-traditional decisions are emphasised, since through the exchange of views we are better equipped to find a key to

BSR Policy Briefing 1/2016

the political deadlock and decide together how to go forward. Theodore Roosevelt, President of the United States, 1901-1909, once said: *“In any moment of decision, the best thing you can do is the right thing, the next best thing is the wrong thing, and the worst thing you can do is nothing”*.

These thoughts encourage us to pursue active change management. I hope that this publication produced for the 9th annual Baltic Sea Forum of Finland offers an intellectual journey into the maritime cluster in the Baltic Sea region and beyond. On the behalf of the Centrum Balticum Foundation, I wish to express my sincere gratitude to all the authors of this book, who have made this literary expedition possible. However, please note that the Centrum Balticum Foundation does not take any responsibility for the accuracy of the information and opinions presented in the articles.

EU support to unlocking blue growth opportunities

João Aguiar Machado

Seas and oceans are drivers for the European economy and have great potential for growth, employment and innovation. To capitalise on this growth potential the EU launched its "Blue Growth" strategy in 2012.

Blue Growth is the EU strategy to support growth and competitiveness in the maritime economy through innovation in the marine and maritime sectors. It is part of the overall efforts to achieve transition to a more competitive and knowledge-based EU economy – and specifically the transition to a modern and sustainable maritime economy, built on optimising the deployment to the market of innovative research results in the shape of new technologies, products and services. An example of this approach is the European Commission's work on ocean energy, which focuses on industry-driven strategies aimed at facilitating the growth of a new sector by facilitating access to financing, and stimulating development and investment.

Blue Growth spans multiple industries covering ocean and ocean-related activities such as maritime transport and ports, shipbuilding and marine equipment technology, tourism, seafood including fishing and aquaculture, oil, gas and mineral resources, offshore energy, and the related supply chains.

In 2014, the European Cluster Observatory identified Blue Growth as one of the 10 Emerging Industries¹ with above average growth potential due to its high level of innovation and cross-sectoral character. With more than 5 million employees, blue economy industries correspond to between 3% and 5% of the EU's economy, depending on the way it is measured. The fastest growing has been offshore wind, which was negligible in size seven years ago and is expected to employ 175,000 people in 2030, almost 2.5 times the number in 2014.

The European Commission supports blue growth through targeted initiatives such as the ocean energy initiative, through sea basin strategies, investments through Horizon 2020, the Structural Funds and the European Fund for Strategic Investments, leveraging national and regional co-financing as well as private investment.

In the Baltic Sea area, the EU Strategy for the Baltic Sea Region was complemented in 2014 through a dedicated Blue Growth initiative². As a whole, such dedicated strategies are aimed at encouraging the development of maritime economy-related projects in regions that are keen to make Blue Growth part of their priorities for Structural Funds investments.

¹ C. Ketels and S. Protsiv, Center for Strategy and Competitiveness, Stockholm School of Economics, European Cluster Panorama 2014, European Cluster Observatory.

² http://ec.europa.eu/newsroom/mare/itemdetail.cfm?subweb=342&lang=en&item_id=16493

1. The role of maritime clusters in driving blue growth

Stimulating smarter, more strategic and more focused public investments that leverage more private and public investment is at the forefront of the EU's jobs and growth agenda. Cluster development as a policy tool within wider smart specialisation strategies play an important role in this. Maritime clusters are at the heart of many smart specialisation strategies. Two examples from the Baltic Sea region:

1) The Region of Schleswig-Holstein in Germany has selected blue growth and the maritime economy as one of the 5 priority areas for its regional smart specialisation strategy, supporting innovation and cluster support in shipbuilding, logistics, offshore technology, ocean research technology, marine biotechnology. Innovative ocean technology is one of the domains of the national research and innovation strategy for smart specialisation.

2) A bit further east along the Baltic Coast, the Polish region of Pomorskie has set offshore, port and logistics technologies as one of its 4 priority investment areas. Blue growth through innovative ocean technologies is also one of the national priority areas for research and innovation in Poland.

Clusters focus the attention of investors and policy makers on the day-to-day interactions by which companies complete transactions, share technologies, develop innovations, engage in partnerships, start new ventures and create jobs and growth.

There is broad consensus that strong clusters foster productivity, industry growth and resilience. There is also evidence that firms participating in cluster initiatives outperform firms not participating in cluster initiatives.³ In particular, small and medium-sized companies can benefit from cluster services, in particular to help them to better access international markets or to develop targeted training and apprenticeship schemes.

Because of their cross-sectoral nature, maritime clusters in particular are “springboards” for new and competitive technologies based on collaboration among companies and research institutions. A specific example is the shipping and shipbuilding sector which has developed some of the world’s most progressive technologies for reducing ship emissions over the past decade, not least starting in the Baltic Sea.

2. Baltic Sea Region as model demonstrator region for blue growth

The Baltic Sea Region is a world-leading performer in maritime technology development and Blue Growth. Many of the countries and regions around the Baltic Sea are among the top innovation regions in Europe. Others are working hard to catch up guided by their smart specialisation strategies. The Baltic Sea Region has, thus, a strong potential to become a pilot region in the different areas of the blue economy. This requires not only strong public support for transformative blue economy related investments but also strategic transnational co-operation and co-ordination to pool resources, reduce fragmentation and strive towards more critical scale and leverage more industry investments.

³ Cf. The concept of clusters and cluster policies and their role for competitiveness and innovation: main statistical results and lessons learned, European Commission, 2008, p. 22 and European Cluster Excellence Scoreboard, European Cluster Observatory, 2013, p. 64.

For instance, almost half of the actions of the EU Strategy for the Baltic Sea Region (EUSBSR) are of maritime nature. But it has also been found that there is significant room for co-ordination and alignment of funds, in particular European Structural and Investment Funds, towards common priorities and joint roadmaps in strategic blue economy areas. While this is a task for public authorities, cluster managers and cluster organisations have a crucial role to play as well.

3. Supporting strategic approaches towards blue growth

As one of the follow-up measures to its agenda for sustainable Blue Growth in the Baltic and the related master plan initiative, the Commission is preparing to launch three calls for proposals in early 2016, aimed also at supporting the activities of maritime clusters:

- 1) a "Blue Careers" call with a budget of € 3.45 million to address education and skills needs in the maritime area, based on partnerships between education and business;
- 2) a "Blue Labs" call with a budget of € 1.7 million to support multi-disciplinary approaches to develop innovative solutions for maritime and marine challenges; and
- 3) a "Blue Technology" call with a budget of € 2.5 million to support transnational public-private-partnerships in developing joint implementation roadmaps to co-ordinate blue growth innovation investments at sea basin level.

While these calls are open to all sea-basins, we are currently considering to elaborate in collaboration with key stakeholders, a set of joint and co-ordinated priority actions and projects, to further support strategic co-operation on blue economy investments around the Baltic Sea.

The Baltic Sea Region is among the most dynamic, competitive and innovative areas in Europe, particularly in the maritime economy. This is a very good starting point for the development of future-oriented strategies to secure competitiveness, jobs and growth for the long term. The Baltic Sea Strategy, and its maritime component, combined with the funding instruments proposed at European level, offer the right framework and tools to harness blue economy-related jobs and growth through better and more strategic co-operation – so all that needs to happen is to get to work and build the Baltic's maritime future today.

Evolution of the maritime cluster in a changing world

Tuomas Routa

There is a saying “*In old days, the ships were made of soft wood and sailors of iron but nowadays the ships are made of steel and men of soft wood*”. The saying, in its own way, is telling the history of the advances in shipbuilding technology to meet the demands of the changing world.

The world is permanently in change, and thus we need to be prepared for the future or at least to adopt our doings to these changes to survive. This is a fact also for the maritime cluster, which is one of the most significant industrial sectors in Finland's economy.

Finland is hosting the European Maritime Day 2016 in Turku. The event is titled “*Investing in competitive blue growth*” and is focusing on smart and sustainable solutions for Blue Growth. Blue Growth Concept is an adopted long-term strategy to support sustainable growth in the marine and maritime sectors as a whole in the European Union. To promote Blue Growth we need not only investments, including investments in clean energy, but we need also to boost skills development and facilitate joint actions.

It is clear that the maritime economy offers significant scope for growth which is based in innovation and clusters. And strategic transnational co-operation and investments roadmaps are considered to catalyse and co-ordinate cross-border activities.

In order to gather information on the trends, emerging issues and threats for international shipping Finnish Transport Safety Agency Trafi arranged a workshop in November 2015 to consult our shipowners, shipyards, industry and public actors. In the discussions, three central topics clearly emerged: digitalisation and automation in shipping, fight against the climate change and smart regulation. The findings are to some extent linked to each other, as technological development can help us to respond to challenges arising from climate change, and smart regulation can, in turn, facilitate technological development.

It is very important, how our maritime cluster is planning to adopt its workings e.g. to the emergence of intelligent ships that will be remote controlled, autonomously operating and fully sensed (ship awareness). Further challenges are the use of software for collecting and analysing data from the ship and on that basis creating tools for optimising the ship's performance. It is important to consider, how the data is collected, verified and stored – and what are the tools for these activities. Furthermore, it is crucial to safeguard cybersecurity in intelligent ships. Overall, the question reads, what kind of evolutionary impacts these trends and emerging issues of shipping will have on maritime cluster?

We, in maritime administration have been very proud to introduce innovative and high quality products of the Finnish Maritime Cluster at global level e.g. in IMO meetings. The LNG-fuelled passenger ship Viking Grace, which is trafficking between Finland and Sweden, is in all respects the most energy efficient and environmentally friendly ship of its type. The ship and her operations were introduced in a side event during the Marine Environment Protection Committee (MEPC) in 2013 in IMO: “*LNG and biofuels for ships - new Finnish solutions in operation*”.

BSR Policy Briefing 1/2016

There are also a lot of activities in the marine industry in developing new propulsion power, like electricity and wind. Last year Finland introduced in the MEPC meeting of IMO the awarded Norsepower company and the results from the commercial pilot project using Flettner type auxiliary wind propulsion technology.

Finnish Maritime Cluster is traditionally been very innovative and this innovative activity, including research and development (R&D), is positively related to firm-level productivity, performance and market position. And radical innovations are needed to meet the needs of emerging markets.

It is important for our maritime cluster to meet the challenges of the day and the future to survive and to make true the future saying *“In old days, all the ships were steered by men by the stars and nowadays the ships are steered by computers through the satellites”*.

The Finnish maritime cluster co-operates for growth

Merja Salmi-Lindgren, Janne Peltola, Ulla Tapaninen, Juha Valtanen, Olof Widén, Elina Vähäheikkilä, Pekka Rouhiainen, Pekka Pokela, Mervi Pitkänen, Arto Alho, Pentti Häkkinen and Sari Repka

Executive summary

The Finnish Marine Cluster (Suomen meriklusteri), which includes the marine industry, seafaring operations and harbour operations, has increased its close co-operation to facilitate faster growth in all three areas. The cluster has a strong foundation, because Finland has a centuries-long tradition in all things related to the sea and the industry employs about 40,000 people.

The marine industry is a trend sensitive industry, which has been heavily influenced by the world economy and political developments. In the beginning of the decade, the marine industry was in recession despite excellent products and know-how. To speed up the marine industry's renewal, the Ministry of Employment and the Economy started a development plan for the operational environment (the TEM-Meri programme) in December 2013. The main purpose of the programme is to preserve and develop industrial excellence in Finland. The following investment target areas were selected to create suitable conditions for growth and competitiveness: building better co-operation between companies and research facilities, positioning the Finnish company networks for international markets – especially to Norwegian and Russian markets, developing new business and revenue models for the operators in the marine industry, developing new products, services and know-how, as well as identifying markets.¹

Ten projects were chosen for the programme. Nine of these projects will be presented in this article. The Helsinki's MerIT and Machine Technology Center Ltd.'s MerIT Turku projects are meant to bring together the companies that develop intelligent technologies for the marine industry. These companies are hoped to form a part of the renewing Sea Cluster. Examples of intelligent technology are systems which communicate with land servers and send data about the engines of the vessel to maintenance. Besides transferring data, the existing ICT systems can save energy and increase customer satisfaction.

Developing the co-operation network of the Sea Cluster – the main goal is to implement the Zero Vision Tool ZVT co-operation platform for wider use. The project also focuses on data distribution, fund raising, increasing international co-operation and co-operation between the research community and the industry. The project has also set up meetings and launched a webpage where knowledge about the industry will be gathered. The project is based on the co-operation between the Finnish Shipowners' Association, the Finnish Port Association, the Finnish Port Operators Association and the Finnish Marine Industries.

The Merien markkinanäkymät project (Market Outlook for Marine Industry) is developing a proactive process, which will produce information on markets for the companies in the Sea Cluster and its

¹ Introduction to Finnish marine industries and chapters 1-5 are written by Secretary General Merja Salmi-Lindgren of Finnish Marine Industries together with Ministerial Adviser Janne Peltola of Ministry of Employment and the Economy.

stakeholders. Data evaluation has a significant role in anticipating the markets. This project has participated in international co-operation, produced market reports and organised industry events.

The network-based operations model is being developed in Prizztech's project called 'Meri- ja teknologiateollisuuden asiakaslähtöinen kasvu' (Client based growth in the Marine and Technology industries). The aim is to develop an operations model where the small and medium-sized (SMEs) businesses group-up to have enough resources for larger projects. The project has advanced ventures with a joint turnover of € 50 million.

The Team Arctic project from The Federation of Finnish Technology Industries aims to increase the co-operation between Finnish companies and to increase marketing in the Arctic area. The main goal is to participate in large international contracts. Numerous decision-makers and investors have been met during the project. The project has also created successful trade relations.

The Trimmi Project will analyse the world market and the needs arising from the analysis. The target markets are the traditionally strong market areas of the marine industry, as well as the new growing market areas. This project has organised seminars with the aim of internationalisation and invested into data collection from growing markets, such as Mexico.

FinBraTech is a network of Finnish and Brazilian universities and educational institutions providing help and support for Brazilian and Finnish marine and technology industry companies in their businesses and international co-operation. FinBraTech is co-ordinated by the Turku University of Applied Sciences.

The joint venture between the cities of Turku and Rauma is developing new, modern operational environments for the marine industry. Another goal is to start up marine industry operations, which will renew the shipbuilding industry. The project focuses on developing the joint venture between four Finnish technical universities called Turku Future Technologies and the industrial zone called the Blue Industry Park designed close to the Turku Shipyard. The City of Rauma is also developing its Seaside Industry Park.

The Virtualexpo project, hosted by the Brahea Centre of the University of Turku, has a goal to develop a new presentation platform for Finnish companies in the marine and technology industry: A 3D fair for the marine and technology industry. In particular, the virtual 3D fair will serve to present the products and services of small and medium-sized companies to international clients. The project will test the 3D implementation in co-operation with companies.

1. Strategically important Finnish marine industry

Finland is a maritime nation. About 90% of its exports and 80% of its imports are carried by sea. The high proportion of foreign trade transported by sea makes it essential that sea routes are well-functioning, reliable, safe and environmentally friendly. Good maritime connections are vital for the competitiveness of Finland's businesses and economy and for the Finnish society in general.

The Finnish maritime cluster employs 40,000 persons, which is 2% of the total Finnish workforce. The cluster's annual turnover is € 14 billion, 4% of the total Finnish output.

BSR Policy Briefing 1/2016

Today, marine industry is one of the key industries of Finland. It consists of shipyards, repair and offshore yards, equipment manufacturers, turn-key companies, design and engineering offices and software providers. There are 450-500 marine industry companies which employ 20,000 persons. Marine industry turnover is € 6 billion, and over 90% of the production is exported.

Out of the 20,000 employees in the Finnish marine industry, shipyards, repair and offshore yards employ 15-20%. Big and global technology manufacturers (propulsion systems, cargo handling, et cetera.), as well as design and engineering offices, et cetera, employ 80-85% of the industry's employees.

Over the last decade, the Finnish marine industry has made new innovations, especially targeted in making ships greener: increasing the energy-efficiency of vessels e.g. by hull design; and developing some alternative fuel solutions, not only LNG-powered but also bio-fuel-powered.

The Finnish shipyards concentrate mostly on new buildings, excluding one repair yard that executes repair projects only. In the last decade, the shipyards have concentrated in building the most modern and environmentally friendly cruise ships (7 out of 10 largest cruise ships in the world are built in Finland), passenger vessels, and specialised Arctic vessels, e.g. icebreaking offshore vessels (60% of the world's operating ice breakers are built in Finland).

Finland has over forty years of experience in completing enormous oil platforms. The majority of the floating, deep-sea Spar-type oil platforms are designed and constructed in Finland – they have never to date sunk. Besides the Spars, the Finnish offshore industry designs and manufactures offshore equipment related to wind power and many types of supply vessels.

The Finnish equipment manufacturers, also called material and system suppliers, manufacture many famous products, such as environmentally friendly LNG-fuelled engines aimed at conserving the environment, and the most advanced propulsion systems for energy efficiency. Other Finnish innovations include the Hi-Fog fire protection system, which extinguishes fires with water mist.

Material and system suppliers are of great importance, as their share of the marine industry is bigger than that of the shipyards. Many of them are global operators.

Some of the most luxurious public spaces in cruise ships are made in Finland. Some of those were also complex to build: Oasis-class cruise ships have the first floating bar at sea. The Finnish turn-key companies are able to deliver complete spaces for vessels, for instance, fully equipped kitchens, stairways, restaurants and cabin modules.

Did you know that the Titanic II was designed in Finland? The Finnish design offices offer a wide variety of consulting, design, research and development services as well as software for the design and operation of ships. In addition, they provide feasibility studies and develop tools using the latest technologies, such as 3D- modelling.

2. Shipping contributes to wellbeing

Finland is very dependent on shipping for its national prosperity and wellbeing. The wellbeing of the Finnish economy will be increasingly dependent on international trade. The country's location on the

northern fringes of Europe, the long distances to Europe's main markets and the difficult winter conditions all place Finland in a special position in relation to many other EU countries. Finland and Estonia are the only countries in the world whose ports all freeze over in normal winters.

The Finnish shipping industry naturally co-operates with the entire maritime cluster, including the transport chain, equipment manufacturers, authorities, researchers and organisations working to protect the Baltic Sea. The facts of trade dependent on sea transportation as well as freezing ports have been a catalyst for Finns to develop innovative Arctic technology and know-how, the Baltic Sea having served as a prototype workshop of sorts.

Icebreaking is an essential service for Finland's maritime transport. All Finland's seaports have ice conditions in winter, though the need for icebreaking services varies from one winter to the next. Finnish icebreakers with Finnish crews have also operated in the Beaufort Sea and the Chukchi Sea to ensure that the circumstances for operations are safe.

Currently, nine icebreakers are needed in normal to moderately severe winters in order to maintain the targeted service level. There will be a new 10th icebreaker brought into service in summer 2016. The ship will also incorporate oil spill prevention and a response and emergency tow capacity for open-water conditions, and it will be powered by dual-fuel engines capable of operating on both liquefied natural gas (LNG) and low sulphur diesel fuel. This ship will be the first LNG-powered icebreaker in the world. Finland will not forget eco-friendliness during harsh winters either.

3. The tide is high

In the aftermath of the financial crisis of 2008, the production in global shipbuilding industry decreased for four years in a row in 2009-2012. The crisis also hit the Finnish shipbuilding industry, and especially the yards of Korean STX in Rauma and Turku. Eventually STX closed down the Rauma yard in September 2013.

The State of Finland and the German shipbuilder Meyer Werft purchased the whole share capital of STX Finland Oy in August 2014. Meyer was the industrial lead investor with its 70% ownership share, carrying the main responsibility for the Turku yard's operations and its further development. State's ownership share was 30%, through the Finnish Industry Investment Ltd (the FII, a fully government-owned investment company).

The FII investment was done following the FII's normal investment policy and criteria. Furthermore, taking into account the fact that the FII only acts as a co-investor (in the minority role), the investment was done fully on market terms. Moreover, in August 2014, it was published that the FII has the possibility for an exit at a later stage – in line with the FII's normal practice.

Later on, the 17th April 2015, it was published that Meyer had decided to further invest in the Turku shipyard using the call option, on which was agreed upon when the investment was done with the FII. Meyer became the 100%-owner of the Turku shipyard, and the change in the ownership structure became effective in June 2015.

During the crisis, the Ministry of Employment and the Economy appointed a task force in 2013 to give recommendations for the renewal of and fostering for the competitiveness of the Finnish marine

industry. The Ministry and the taskforce believed that there was and is room for Finnish shipbuilding, although the shipbuilding industry had (and still has) global over-capacity and the building of more hi-tech complex ships is moving into lower-cost countries.

The taskforce saw that the increasing activity in the Arctic would create demand for Finnish technology and services (including shipping), as we have world-leading Arctic know-how. Thus, e.g. the Arctic maritime R&D should be increased. The taskforce also saw a need for a special development programme targeted into the marine industry. These two proposals of the taskforce were also executed, and two programmes were set up; the Arctic Seas and the TEM-Meri.

4. The Finnish Marine Industries, a co-operation forum

The Finnish Marine Industries is the co-operation forum for high-technology maritime solution providers, leading marine equipment manufacturers, turn-key suppliers, designers, for software and system providers; as well as for shipbuilding, ship repair and offshore yards. The association promotes favourable conditions for its members in the industrial and economic policy among the companies. It is a centre of knowledge, furnishing its members, public authorities and the media with the latest relevant information on the Finnish marine industry sector. Currently, the Finnish Marine Industries has circa 80 member companies.

The association promotes sector networking in Finland, co-ordinates national research and product development, and promotes the application of EU shipbuilding policies in Finland. The Finnish Marine Industries represents one branch of the European Ships and Maritime Equipment Association – The SEA Europe.

5. Tekes' Arctic Seas Programme

The € 100-million Arctic Seas programme by Tekes (the Finnish Funding Agency for Innovation) was launched in the end of 2014. The programme will help speed up the development and introduction of new products and services in the markets. The key business areas of the programme are environmental technology, Arctic and other maritime transport, offshore industry, maritime industry, and new business based on the Arctic expertise. A competitive edge will be sought particularly in the environmental and ICT know-how. Blue Growth is one of the key elements as well.

6. TEM-Meri ²

In 2004, the Ministry of Employment and the Economy launched the TEM-Meri, a three-year-development programme of the operational environment. The primary aim of the programme is to strengthen the competitiveness of the Finnish marine industry and to spur the regeneration of the industry. One of the key elements is also the strengthening and fostering for the co-operation among the whole Finnish maritime cluster; that is, the marine industry, shipping industry, ports, and port operators. Some of the themes are building co-operation between companies and research institutions, creating new business

² 'Meri' is a Finnish word for sea.

models for marine industry actors, and recognising new products, services, and markets. 10 different projects in total were launched, and the results of the programme will be seen at the beginning of 2017, when all the projects will have ended and been analysed.

The following TEM-Meri programme projects are introduced below.

1) MerIT

1.1) MerIT: Digitalisation will change the way we understand shipping

Ulla Tapaninen

1.2) MerIT TURKU: Building ongoing processes

Juha Valtanen

2) Collaboration crucial for the Finnish maritime cluster – stronger together

Olof Widen

3) Market Outlook for Marine Industry: Analysis of information is the key

Elina Vähäheikkilä

4) Prizztech: Customer-oriented growth in marine technology

Pekka Rouhiainen

5) Team Arctic: Potential of the Arctic region

Pekka Pokela

6) Trimmi: Promoting international growth

Mervi Pitkänen

7) FinBraTech: SME's possibilities in Brazil

Arto Alho

8) Turku Seas 2020: Fostering marine industry competitiveness

Pentti Häkkinen

9) Virtualexpo: Visualising products in 3D

Sari Repka

6.1. MerIT

6.1.1. MerIT: Digitalisation will change the way we understand shipping

In January 2016, the shipping world was stunned; Amazon China announced that it had been registered as an ocean freight service provider. In other words, Amazon quietly builds its own shipping company. Why would one of the largest and most successful companies in a different business area expand its services to shipping when it operates in more lucrative business sectors?

The answer lies in digitalisation; almost all business sectors and industries will go through transformation to digitalisation – if not now, then soon. Naturally, this holds for shipping, as well. Mastering shipping digital information will change the whole industry, and the disruption has already begun. It will bring changes to the existing business models and offer new opportunities. But what does it mean concretely? Here, we are actually talking about three different things happening at the same time.

The MerIT project: It is likely that big data, open innovation systems and solutions based on disruptive business models will change the fundamentals of marine traffic. The City of Helsinki started a project called MerIT a year ago. Its goal is to bring together smart marine technology companies and to form a successful cluster around them. The companies range from traditional marine industries – machine manufacturers, shipyards and shipping companies – to small and large ICT-companies offering smart solutions, for example, for ice and weather monitoring and observation; usability; data transmission; and navigation.

Opportunities of big data and the industrial internet: In land-based operations, we have learned about driverless cars, which can drive autonomously; about machines that collect data using cost-effective and tiny sensors, transmit them using wireless networks, and analyse the gathered data in order to help controlling and operating these machines. Moreover, we are using various mobile applications in our portable devices that provide services we have not even previously dreamt of. In addition to all this, the big data provides and the data mining analyses humongous databases full of information.

However, only a small fraction of this has been possible in the maritime business sector due to the long geographic distances. When a vessel is far away at the sea, it has been extremely expensive to transmit data about the vessel's navigation systems, weather, hull condition, machinery, water systems, et cetera on shore to be analysed. However, recently the decreasing costs of satellite data transmissions and new cheaper data exchange systems at radio frequencies have lowered the barrier for the maritime industrial internet. In addition, sensors developed for land-based operations are getting smaller and cheaper to facilitate more extensive monitoring.

Ship equipment maintenance, for instance, used to be done only at fixed intervals or once equipment failed to operate. Remote asset management allows land-based service teams to assess situations in advance without unscheduled and unexpected maintenance stoppages. Furthermore, sharing vessel asset information in a cloud service enables effective and agile fleet management of even the smallest freight and passenger fleets. New information will adjust vessel speed and routes; and thus bring considerable savings. Cruise passengers will have mobile applications to serve their needs both on sea and at land. In the near future, technology will make it easier to order food and drinks, find and stay reminded of interesting entertainment, and even open one's own cabin door. Furthermore, remotely operated and autonomous vessels are already on the drawing boards.

From closed-loop innovation to open innovation models: For a long time, major innovations in the maritime industry were born inside large corporations. Examples are multitude: azimuth thrusters, icebreakers with asymmetric hulls, and the world's largest cruise vessels.

However, traditional closed innovation systems are not capable of competing with new open innovation ecosystems, where professionals from various disciplines come together to solve problems in one industry. Future innovations in the maritime industry will be influenced by car manufacturing, air traffic operations and shopping centres, to name but a few. Academic scientific projects are and will be necessary for the industry and high-tech innovations, but unfortunately their commercialisation timeframes are often too long.

Examples of open innovation models in shipping are still few and far between, but already some companies have opened up their data interfaces for external developers. Wärtsilä's Marine Mastermind contest, a 'quest for a game-changing start-up', will develop the next generation of digital services,

exemplifying the necessary change of tactic as large multi-national organisations have to reach out to external companies for the best ideas. In mid-February, TallinkSilja hosted the 'Hack the Ship'-event and invited hackers to rethink how technology can be used in ships to create a better experience.

Disruption of the industry – from products to services: However, the biggest change will be in the disruption of the business models. When we think about the effects of digitalisation on industries, we must remember that disruption is not only about products, it is about business models. Business models, not products, are disruptive. Digitalisation offers new opportunities for business disruptions. For instance, Uber or Airbnb did not invest in new cars or new couches, they invented new business models.

The maritime business sector has evolved over a long period of time into the present system, in which multiple actors, such as freight forwarders, stevedores, ship owners, non-vessel operating common carriers (NVOCCs), ship management companies, insurance companies, et cetera, all have their own roles and positions in the value chain. But the whole system could also be very different, for example, ships independently collecting their cargoes in the world's ports, similarly as Uber-drivers are collecting their customers, or as containers are rerouting themselves autonomously within the network of container lines.

Several new ICT-based innovations and solutions have already found their customers with urgent needs for data transmission, energy saving or customer satisfaction increase. Big data offers opportunities for open innovation models. Nevertheless, this is not yet a disruption. The disruption of the business model may be lurking just around the corner. What will happen when Amazon starts combining the transport needs of multiple customers in a new way? We will know soon, sooner than we think.

6.1.2. MerIT TURKU: Building ongoing processes

The aim of the other Finnish maritime promotion project MerIT Turku is to find ways to strategically incorporate and utilise ICT-related solutions in the maritime technology industry, as well as to promote the role of the maritime industry as a forerunner in the utilisation of modern technologies. The MerIT Turku is a sister project for the larger Helsinki-based MerIT initiative. Both of these projects were commenced in the autumn of 2014. For the MerIT Turku, the main financing was supplied by the Ministry of Employment and the Economy and the City of Turku.

In the MerIT Turku project, three new maritime ICT-innovation events have already been scheduled to take place between the autumn of 2015 and the spring of 2016. One of the main themes will be 'Augmented Reality', aiming for the improved illustration of maritime design schemes with the aid of new ICT-applications. Next innovation events will concentrate on remotely operated and autonomous vessels. In the future, it is essential to build an ongoing process between the industry, authorities and universities to increase digital collaboration and creation of new businesses possibilities for digital services.

6.2. Collaboration crucial for the Finnish maritime cluster – stronger together

The key Finnish maritime associations, respectively the Finnish Shipowners' Association, the Finnish Port Association, the Finnish Port Operators Association and the Finnish Marine Industries, have strengthened

co-operation within the Finnish maritime stakeholders. The overall aim is to support new investments and research projects, as well as to increase jobs and orders through a better collaboration.

The network for the Finnish Maritime Cluster was founded to assist in developing new project ideas and in finding partners to start real investment projects with. The objectives are to optimise the use of existing funding instruments, to share knowledge and to increase international co-operation, as well as to enhance co-operation between the industry and the research community.

The aim of the associations to intensify the co-operation within the cluster was the background for the project. By having everyone work together, Finland can most effectively form new ways to activate R&D co-operation within the branch. In Finland, the marine industry is the main actor for development, and the shipping industry in Sweden. The two neighbour countries are already doing a substantial amount of co-operation; a good example being the icebreaking co-operation.

The Finnish Maritime Cluster works as a link between different stakeholders, enabling information exchange and the exchange of best practices. The Finnish Maritime Cluster collaboration project has set four activities for the two-year project:

- 1) Integration of Finnish stakeholders to the Zero Vision Tool, ZVT, collaboration platform (see the description below);
- 2) Strengthening of co-operation and widening the network;
- 3) Enhancing co-operation between cluster and research; and
- 4) Collecting information regarding different co-funding possibilities.

All of the activities are set for creating a strong basis for the Finnish Maritime Cluster. After the project is completed, the Finnish Maritime Cluster will continue operating under the co-ordination of the founding organisations. The international collaboration is crucial and one of the key themes that will be promoted increasingly in the future.

Integration of Finnish stakeholders to the ZVT collaboration platform: The Zero Vision Tool, ZVT, is an international collaboration method and project platform developed by the Swedish Shipowners' Association and the SSPA Sweden AB for a safer, more environmentally friendly and energy-efficient transport by sea. Within the platform, representatives of industry, academy, agencies and administrations meet to share experiences and find common, workable and sustainable solutions. The core idea of the ZVT to increase transport by sea can contribute to increased economic growth and welfare, while reducing negative environmental impacts, number of accidents and energy consumption. As of today, approximately 130 different organisations from various countries use the ZVT method (www.zerovisiontool.com).

Strengthening co-operation and widening the network: The second step of the project was to enlarge the network by identifying relevant stakeholders of the Finnish Maritime cluster. All interested parties were welcomed to join the cluster, and the contact information of 400 stakeholders was collected. The stakeholders in question have been informed of the relevant news and events. The tight co-operation has been done together with the other projects, and the combined information of the Finnish maritime cluster has been used. Additionally, a website for the Finnish Maritime Cluster (www.finnishmaritimecluster.fi) was created, gathering information among other things about events, research, international co-operation and funding instruments.

Enhancing co-operation between cluster and research: The third objective of the Finnish Maritime Cluster is to enhance co-operation between cluster and research. Close collaboration and active information exchange between the Finnish Maritime Cluster and the research committee of the Marine Industries are crucial points for pursuing those goals. The aim is to have more Finnish participants in the big EU research projects, as well as to secure R&D co-funding availability for the sector in the future. In addition, the ongoing work of the revising and implementation of the Finnish Maritime Cluster's Strategic Research Agenda 2014-2020 will be connected to this activity.

Collecting information regarding different co-funding possibilities: The Finnish Maritime Cluster aims at providing information about different alternatives for co-funding in the EU, the Baltic Sea region and national levels, such as with the TEN-T and Horizon 2020-programmes. For this purpose, the new website of the Finnish Maritime Cluster gathers information about various funding alternatives that might be beneficial for organisations in the maritime sector. Besides, the Finnish Maritime Cluster has organised seminars, which presented EU-funding opportunities (especially the Connecting Europe Facility). These, together with activities of the cluster, aim at a cleaner Baltic Sea.

6.3. Market Outlook for Marine Industry: Analysis of information is the key

Marine operates at international markets and opening of new business areas quickly influences demand. In a highly competitive environment, all new possibilities have to be found quickly, and the meaning of anticipating developments is a significant factor. On the other hand, all projects are large investment projects with product development that may take decades. For this reason, one has to have an excellent understanding of the long-term development scene of the sector.

Market trends have rapid influences on marine industry, since the amount of sea cargo is tightly connected to the development of the world's economy. This is also why there is a crucial need for information about market trends and newly opening markets in the marine industry. Different vessel type order quantities are dependent on cargo quantities and the growth rate of shipping's various subsectors. Driving forces are, for instance, the increasing popularity of cruises in the passenger ship markets, increasing maritime traffic, and in a wider perspective the population growth or the transportation leaning more on the sea because of eco-effectiveness. The amount of ships scrapped and the age structure of the fleets also influence the order quantities of ships. Market information is also a pivotal starting factor when setting up product development goals.

The goal of the Finnish Marine Industries' project Market Outlook for Marine Industry is to establish a continuous effort to gather, refine and share information about the markets. This effort is designed for the benefit of the whole sector. The main function of the Finnish Marine Industries is to monitor the benefits of the sector's companies and to influence on their behalf. One of the most significant aims of the association is to maintain the competitiveness of the Finnish marine industry by offering clients progressive, sustainable and high-quality products. The project offers the entire picture of the outlook for the future, and thus ensures a better-planned development of the working environment and improvement in competitiveness. The companies themselves also analyse the gathered information. As a result, they can answer market needs by directing product development more correctly and marketing more efficiently. The Finnish Marine Industries also participates actively in the international forecasting co-operation.

A goal of the project was also to collect data and to inform companies about the sources of the gathered market information. Thus, the Finnish Marine Industries' web site has opened 'Markets' section, on which general information and public marketing reports as well as relevant links can be found. The cluster co-operation has gained positive feedback from various companies. Already, the information has been utilised in directing research, planning company projects, defining research focus themes, and updating the Strategic Research Agenda.

6.4. Prizztech: Customer-oriented growth in marine technology

A traditional leader company model is needed to produce growth in companies. In this model the international companies operating in Finland bring small and medium-sized business with them into export operations. Before, this was mostly about manufacturing products. Today, more and more of the manufacturing volume is focused on smaller technologies and specialised manufacturing. This operation method is suitable and familiar to small and medium-sized businesses. Prizztech's project called 'Meri- ja teknologiateollisuuden asiakaslähtöinen kasvu' (Client based growth in the marine and technology industry) has been especially focused on another kind of a model – a network-based model.

In a project belonging to the TEM-Meri programme, the focus has been on the concrete needs of offshore clients taking into consideration the possible client layers. The main target client group has consisted of the EPCM contractors (Engineering, procurement, and construction management), which typically deliver the largest entities for the investment projects of oil companies. Knowledge and understanding of the markets is vital as the potential client companies are not only the few large companies, which make straight investments, but also their suppliers on many different levels. The drop in oil prices has restricted the market, but at the same time, it has created new opportunities for Finnish companies as the diminishing margins of the clients demand more competitive solutions and open the market up for new cost-efficient companies.

The basic idea of this venture has been that to create growth a network model is required. In this model, the small and medium-sized businesses aim straight for exports by grouping up in order to have enough resources for export operations in a joint manner. The necessity of this model has been brought up especially recently. Small and medium-sized companies feel that, for the foreseeable future, the domestic market is not going to attract business like it has. This leaves companies with the option of either cutting down their operations or starting to work on exporting.

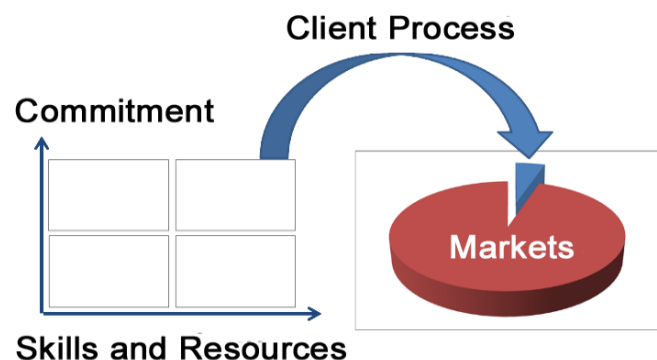

Image: Building a client focused supply and a systematic client process – You need a strong commitment and the necessary skills and resources for exports.

BSR Policy Briefing 1/2016

The operation model based on a client focused supply and the systematic implementation of client processes executed in the project has proven itself to work well in practice, and it has been used to generate results, such as turnover.

It has become evident during the project that in order to support the client processes related to the exports of small and medium-sized companies, the public sector must offer strong, creative expertise in building a competitive supply based on the identified client needs. It is also clear that there must be capacity to see any business initiatives through far enough. In practise, this means co-operation at least to the end of a prequalifying phase. These initiatives must be seen through as co-operated ventures between public operators and small and medium-sized businesses.

To facilitate growth, new small and medium-sized businesses with exports and growth potential must be found. Their entry into the export market must be supported in the described manner.

It became evident during the project that there is a potential group of businesses that have good products and are committed to starting exports, but are still trying to find a suitable way to execute their strategy.

From these basics, Prizztech's project called 'Marine and technology industry focused client-based growth' will further develop thirty separate subprojects, which have over 40 participating companies. Of these subprojects, a third have been selected as strategic investment targets for the last year. Concrete results are expected from these projects already during 2016.

Export activities to Norway and Russia: In October 2015 and in the scope of the project, Prizztech participated in the OTD (Offshore Technology Days) trade fair in Stavanger with its Norwegian partner Viken Olje & Gas Netverk from their show stand. The show stand was located directly opposite the Team Finland stand and offered an efficient negotiation space for client meetings. Finnish Offshore Industry 2015 and FinnOffshore Directory brochures were in distribution on the stand.



Standing from left to right, in front of the Prizztech OTD 2015 stand, are Ulf Haga, Hentec Oy; Pekka Rouhiainen, Prizztech Oy and Pekka Kääriäinen; Javasko Oy.

In November 2015, Prizztech took part in the Murmansk Business Week event in Murmansk, Russia. The main goal of the trip was to connect with the clients responsible for the implementation of Arctic projects in Russia.

Good results – over € 50 million in turnover facilitated: It is estimated that by the end of 2016, the companies involved in the project will have generated over € 50 million revenue from the subprojects Prizztech has played a pivotal part in. According to plan, this year's focus will be on international co-operation ventures which aim to increase growth and have Finnish, Norwegian and Russian companies involved.

The client companies, especially in Norway, are interested in new cost reducing options and options which will improve their competitiveness. This co-operation aiming for growth will closely continue between other projects of the client companies, the Finnish Marine Industries and the TEM-Meri project.

6.5. Team Arctic: Potential of the Arctic region

Finnish companies need strong co-operation, shared concepts and government support to start their businesses in the Arctic area. *“We need a ‘Team Arctic Finland’”*, said CEO Mikko Niini from the Aker Arctic Technology in 2013.

Niini led a study called Sustainable Business Opportunities in the Arctic. The study looked for ways to help Finnish companies benefit from opportunities in the Arctic region in a sustainable manner. The study proposed strong co-operation between companies, investments in developing joint concepts, as well as governmental support that opens new doors and unites resources.

“Finnish companies are well-positioned to do business in the Arctic but it is a challenge for them to access these enormous projects in a cost-effective way. We lack our own direct investors and strong project leaders that large projects require”, said Niini 2013.

Leading Finnish companies³ jointly with Tekes, the Finnish Funding Agency for Innovation, financed the study. Also the Ministry of Employment and the Economy supported partly the creation of Team Arctic Finland during 2014 with co-operation of the Federation of the Finnish Technology Industries.

The report, produced by Gaia Consulting Oy, was the starting point for Team Arctic Finland which has been in action now for 3 years. Based on the study, the total value of the Arctic market was estimated to be approximately € 240 billion in 2020. Finland and the Finnish companies needed to tap into this growth potential. The Arctic region offered – and still does in the long run, despite the recent problems low energy price and sanctions have created – new and tangible business opportunities for a large group of Finnish companies, provided that they can innovate and create strong co-operation.

To succeed in the Arctic business sector, Finnish companies need co-operation and visible international marketing of their Arctic expertise and sustainable products and services. Co-operation puts the

³ ABB Marine Oy, Aker Arctic Technology Oy, Arctia Shipping Oy, Cargotec Oyj, Destia Oy, Fortum Oyj, Konecranes Oy, Metso Automation Oy, Outotec Oyj, Pemamek Oy, Rolls-Royce Marine Oy, Rautaruukki Oyj, Terramare Oy, Vaisala Oyj and Wärtsilä Oyj.

companies of Team Arctic Finland in a good position to offer a substantial selection of sustainable products and services for Arctic projects. This kind of collaboration provides a unique way to make high-level contacts and to access large international projects in the Arctic.

Team Arctic Finland⁴ has packaged the Finnish Arctic know-how into Total Concept offerings that have already opened doors to international corporations. These concepts provide a practical way to export the Arctic know-how, and have already led to international business negotiations.

The Finnish Marine Industries led by Mrs. Merja Salmi-Lindgren is an important co-operation partner. *“Co-operation with out state officials and especially with our Embassy network has proven to provide a significant support for our truly international work, too”*, says Pokela, the Business Director of Gaia.

During the past two years, Team Arctic Finland has met the most important investors and decision-makers in the Arctic region. Team Arctic Finland brand and its Total Concept approach has opened doors to high-level decision-makers in key companies operating in the Arctic or other harsh conditions. The strong Arctic know-how and the joint value of Team Arctic Finland’s companies in planning, implementing and operating Arctic projects, have incited interest among international clients. Many discussions seem to be leading to new significant business initiatives. Team Arctic Finland has already produced new sales leads, and active work continues.

Although many Arctic investments have been postponed due to the decline of the oil price and the drawbacks in international politics, Team Arctic Finland has been able to promote the Finnish Arctic knowledge, and companies of Team Arctic Finland have been active, as well. Many stakeholders see Team Arctic Finland as a best practice on how international markets can be reached by combining resources and focusing on specific high-level customer decision makers.

Team Arctic Finland wants to make sure that the best competence, engineering expertise and innovation power is used when planning and executing projects in harsh conditions. The most advanced clean-tech solutions need to be implemented in full scale. The Finnish competence includes knowing how to operate safely in this sensitive environment, combined with high performance and reliability. Nevertheless, strong development and promotion investments are required. Negotiations with international corporations is continuing.

6.6. Trimmi: Promoting international growth

Trimmi (means ‘trim’ in English) strives for the Finnish maritime industry to become a globally competitive and noticed industry, with initiatives for business development in global markets. Trimmi brings the Finnish maritime companies closer to their potential international customers, and the main aim is to bring customers close to the Finnish Maritime companies, for example, by bringing the customers to visit Finland.

⁴ The organisations that form Team Arctic Finland are: ABB Marine Oy, Aker Arctic Technology Oy, Arctech Helsinki Shipyard Oy, Arctia Shipping Oy, ESL Shipping, The Finnish Institute of Occupational Health, The Finnish Meteorological Institute, Lamor Oy, Meyer Turku Shipyard Oy, Pemamek Oy, Rolls-Royce Marine Oy, SSAB, Technip Offshore Finland and Terramare Oy.

In Trimmi as well as other current maritime technology projects, the Machine Technology Center Turku Ltd. works in close operation with the Ministry of Employment and the Economy and also with the City of Turku and the other Meri projects.

Promoting international growth: Trimmi promotes the international growth, development and global positioning of local maritime companies. In addition to this, emphasis is placed on ways to enhance R&D-efficiency by employing new, innovative operational models and collaborative practices. An example of its current actions are the ‘What’s Up?’ forums. What’s Ups are dedicated to help the internationalisation of Finland-based maritime and machine technology companies and universities in order for them to invite co-operation for strategic initiatives aimed at increasing market shares and visibility in various yet specific foreign markets.



For instance, in the summer of 2014, the first ‘What’s Up Global?’ update seminar for the maritime and offshore industries and infrastructure construction was held in Turku. With 85 companies and other operators of the maritime business sector participating, the discussion focused on the market situations and outlooks in Brazil, France, Norway, Russia, and Asia. The seminar was jointly arranged by the Machine Technology Center Turku Ltd, Finpro, and the Enterprise and Business Centre of Southwestern Finland. Later in the same year, the strategic discussions related to the same market areas, now including also Mexico and China, were continued in two follow-up workshop events.

For instance, in the summer of 2014, the first ‘What’s Up Global?’ update seminar for the maritime and offshore industries and infrastructure construction was held in Turku. With 85 companies and other operators of the maritime business sector participating, the discussion focused on the market situations and outlooks in Brazil, France, Norway, Russia, and Asia. The seminar was jointly arranged by the Machine Technology Center Turku Ltd, Finpro, and the Enterprise and Business Centre of Southwestern Finland. Later in the same year, the strategic discussions related to the same market areas, now including also Mexico and China, were continued in two follow-up workshop events.

Trimmi has recently launched activities towards the Mexican maritime markets, in which the Finnish Marine Industries co-operated in the beginning. Collaboration with FinBraTech projects still aims to keep solid relationships with the Brazilian industry. An interesting opening to Singapore is also on the table.

Moreover, Trimmi promotes the Finnish competences by participating in the maritime fairs with companies. This is not a traditional fair execution, but highly strategic activities and branding of the companies competences. The Arctic Waypoint Finland is an Arctic platform for the Finnish competences, knowledge and networks for Arctic products, services and business. The platform gathers together the long-term high-class Arctic know-how in Finland to promote the Arctic business, product and service development, as well as RDI (research, development and innovation) and education in Arctic technology, transportation, logistics and seafaring. The platform provides a ‘gateway’ connection straight to the heart of the Finnish Arctic industry and research networks. Another recent event was the technology seminar in Stavanger in Norway during ONS 2014 fair, arranged jointly with Finpro, with 21 Finnish maritime companies participating.

Trimmi trims the Finnish maritime industry for global visibility and interest.

6.7. FinBraTech: SME's possibilities in Brazil

FinBraTech is a network of Finnish and Brazilian universities and educational institutions providing help and support for Brazilian and Finnish marine and technology industry companies in their businesses and international co-operation. FinBraTech is co-ordinated by the Turku University of Applied Sciences.

FinBraTech can give support for the technology industry by offering RDI-services and training products; by training employees and engineers; by opening educational institutions as exchange points and channels through which to offer education packages and training products for companies and institutions; and by having companies as an important recruitment channel.

Current situation in Brazil: The Brazilian economy and market have had very difficult times during the past couple of years. There are both global and domestic reasons for the difficulties. The drop of oil price and the global situation that is at some degree instable and vague have had a big effect on the Brazilian offshore and oil and gas industries. The Petrobras corruption scandal has had the biggest effect on the sector which is almost synonym to the present political crises in Brazil.

Due to all of these investigations, basically all offshore industry has ceased, unfinished new shipyard projects have stopped or continue proceeding only with minimum efforts. The present situation is going to take few years to be more clear and visible. Petrobras' investment plan for pre-salt⁵ is kept, though it is cut down to some extent.

Possibilities and opportunities: Due to this situation, possibilities and opportunities are limited in offshore, yet it is good to remember that better times are nevertheless expected, and it is always important to show your presence, even during hard times. The strong relations are made during these times, and it is essential that one shows that the work is done in all seriousness, and possible partners are not abandoned during harder times. The time is excellent for companies to buy Brazilian companies with the lower price in Brazil, and also to utilise the weak Real, a currency of Brazil. One can buy quite substantially more than could a couple of years ago.

Regardless of the crisis, there are some businesses that are not directly affected of the offshore problems and the Petrobras case. The need of ship repair and maintenance is still there. There are not so many shipyards or facilities for these types of work, so in some cases, ships in cabotage are taken abroad for repair, overhaul and maintenance. This gives possibilities for the Finnish companies to provide services in this area, and this should be considered so that companies are working together and being able to provide larger entities. Now as the situation in general is difficult, better Brazilian partners might be found and with better terms.

Other area of possibilities is shipyards delivering to agricultural businesses. This is mainly on the Amazon River region. The main items of shipyards there are barges and pushers, and the needs different than in the offshore. Moreover, the technological level of the shipyards on the river is much lower.

The achieved results are very much based on co-operation between companies and students in the Brazilian market. FinBraTech has been able to activate this, and it has increased interest in companies which otherwise would not have had possibilities or time to do the needed work. FinBraTech has

⁵ The pre-salt layer: the oil and natural gas lie on the seabed below an approximately 2000 m deep layer of salt.

marketed and used the Tekes-Finep joint call as a tool to increase interest between companies in Brazil and in Finland in order to start looking for co-operation and development possibilities. The co-operation between universities has been developed, as well.

One good example of a project done by students is the market study for a small Finnish company which manufactures tools for shipyards. The company wanted to know better what sort of potential there was for their products in the Brazilian market. The company is small and therefore does not have capacity to do this by itself. The product is good and has a long history and references in Finland as well as other countries. The Finnish students who were doing their exchange in Recife, Brazil made the market research for the company as part of their studies. Outcome was that now the company knows Brazilian shipyards and their products and especially shipyards at the Recife area and the tool types the shipyards are using in their steel production. And now the Finnish company also knows how and which channels could be used for selling their own tools.

Possibilities together with FinBraTech: As was mentioned earlier, FinBraTech is providing various types services from consulting and RDI-services to student projects and recruiting. Students are the specialty of FinBraTech, and with their help the network can make various different projects strictly based on the needs of companies. These services fit together with the SMEs which do not have such own resources that they could easily plan to enter into the Brazilian market, conduct further studies, or organise other more specific projects in the Brazilian market locally. At the same time, this is a very cost-efficient way of starting to get closer to Brazil in its very large market.

6.8. Turku Seas 2020: Fostering marine industry competitiveness

South Western Finland has a strong position in the country's marine industry, and this shows in figures: number of companies, employees and turnover. Accordingly, the success of this branch is vital to the regional economy and the entire marine cluster of Finland.

The Turku Seas 2020 programme was created to foster the marine industry competitiveness. The original scope included a number of initiatives to promote technology research and professional skills as well as assist SME companies in networking and RDI-projects. The Turku Seas 2020 programme inherently had a catalyst role. The target was generally to initiate and speed-up actions and projects rather than to take the lead position in their execution.

Principal activities have been channelled in two fields: The Blue Industry Park, BIP, and the Turku Future Technologies, TFT. These two concepts at the Turku region – the technical university joint research network TFT and the marine industry park BIP are closely tied together. Neither of them could stand alone. The TFT requires the technical research challenges that the BIP industrial operator can supply.

The Turku Future Technologies: The Turku Future Technologies brings the four technical universities of Finland – the Aalto University, and those in Lappeenranta, Oulu and Tampere – to actively network with the University of Turku, Åbo Akademi University, the Turku University of Applied Sciences and Novia. Facilities and flexible organisation have been provided to allow each university concentrate on 'spearhead' fields and run RDI-projects with the industry. Lively academic mix is aimed at allowing researchers' and students' performance growth. Activities have been based on a wide investigation of

industrial companies' specific research needs. Approximately ten definite research areas could be recognised here, where focused actions were necessary.

The Blue Industry Park in Turku: The Blue Industry Park is a projected industrial concentration in the vicinity of Meyer Turku Oy shipyards. The plans include a large area to accommodate several industrial companies and comprehensive supportive functions. Many of the companies would be suppliers to the Turku shipyard. Many of the companies would operate in marine industry fields. The BIP has been created in close co-operation with the Seaside Industry Park in Rauma, and active co-operation between the cities of Turku and Rauma as well other communities in South Western Finland.

The BIP is planned to be a flexible foothold for companies, allowing operations expansion and also limited time of presence. All these are typical features of large shipbuilding projects. The BIP is planned to have fruitful mutual co-operation with enterprises outside the industry park, benefits are not limited to the 'insiders'.

Major cornerstones: The Blue Industry Park will promote competitiveness in all major cornerstones: logistics, energy supply, new technology, versatile services and leading edge.

In parallel to the principal channels of TFT and BIP, The Turku Seas 2020-group has been promoting technical training in versatile modes and making the marine industry branch an attractive choice for young people.

Seaside Industry Park Rauma: The City of Rauma implements the Rauma part project, which is one part the Turku Seas 2020-project. Its main goal is to develop the business prerequisites for the companies operating in the Seaside Industry Park as well as to improve the co-operation model for small businesses that can be beneficial in the Park. The project has aimed to map the development needs of the head companies as well as other companies situated and operating in the park.

Solutions for any identified needs have been sought with company-specific development and by utilising marine industry development projects, as well as by directing companies to public or private service providers and experts.

The project has improved networking between companies and organised events directed for marine industry companies. Through the project, the Seaside Industry Park has also been marketed for companies and work providers situated in the area.

6.9. Virtualexpo: Visualising products in 3D

Despite the fact that the marine industry is one of the most international fields of industry in Finland, direct exports are dominated by large companies. Exports by small and medium-sized companies are more indirect in nature i.e. they surface, for instance, with deliveries for vessels built in Finnish shipyards. Of the almost 500 companies in the Finnish marine industry, most are SMEs. The large companies have already been doing international business for a long time, but the restructuring of the marine industry in Finland has brought with it increasing needs for internationalisation for SMEs, as well.

BSR Policy Briefing 1/2016

Virtualexpo project stems from the recognised need to help SMEs to go global, especially in the marine and technology sectors. There are existing structures for this, such as Team Finland and private companies with similar ambitions.

There was a need to develop a tool that could be easy to use and enable presence in fairs and expos virtually as well, as this could be more feasible for the smaller companies. The idea was also to combine the Finnish ICT and game industry know-how and to give a fresh perspective. As many companies in the marine and technology industries manufacture products that can be readily visualised in 3D, it was seen as a good angle to start the development. The idea was also to collect the companies under same heading and to give a strong and connected outlook. Our project group consists of four organisations: two units from the University of Turku (Brahea Centre: the Technology Research Center and the Centre for Maritime Studies), Prizztech Oy, and the Machine Technology Center Turku Ltd.

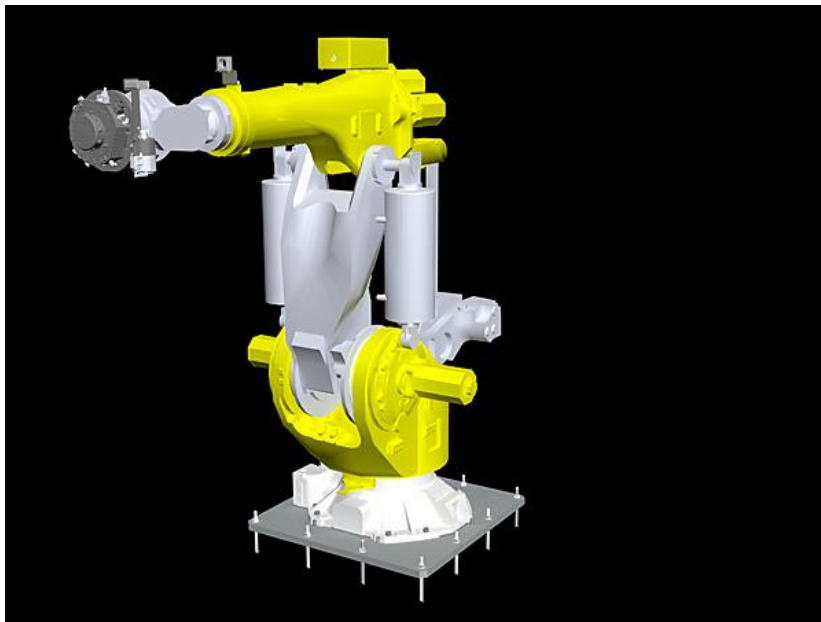

Since understanding of these possibilities is somehow matured, there are large differences between companies in their readiness to join the project. Some have material that can be readily published in 3D-format and some have to start from the scratch.

The technical challenges were resolved, and this helped the project to get to warm its connection with the companies. There were a suitable number of adventurous individual companies and business parks to become our test cases and pilot the process with.

Now the Virtualexpo is in the phase of finding a selling story for the technical solution that is called Sketchfab, and it describes itself as being the YouTube of 3D models. Where will it appear and how will it be used in the future, even after the project lifetime? The project receives suggestions for future developments and scans them continuously while interacting with the companies and other stakeholders. How does the business feel the tool to be the most useful to it? This spring, the Virtualexpo will make an international pilot with Team Finland.

Maritime transport in the Baltic Sea in 2016

Lauri Ojala

Executive summary

Demand for maritime transport is derived demand, and changes in the level of economic activity tend to amplify in logistics services, i.e. logistics demand changes more than that of economic activity. Maritime transport activity in the Baltic Sea reflects this phenomenon very well.

Baltic Sea Region ports handled around 830 tonnes of cargo in 2015, which is about the same amount than in 2008, and about 8.4% of the world total in 2015. The BSR maritime and seaport market has been stagnant over past years, whereas maritime transport has globally grown annually by 3 to 4% since 2012.

The overall market outlook is bleak especially for bulk, tanker and container shipping companies. Maritime freights have generally been at low levels since summer 2008. However, this is good news for shippers, but even record low freight levels do not necessarily generate more transport volumes. The outlook in the maritime world in general, and in the Baltic Sea shipping markets in particular, does not show any signs of imminent improvement for ship owners and operators.

The maritime transport sector has recently been and will be subject to substantial regulatory changes with mainly environmental goals. Complying with these generally involves additional costs as various type of emission or other rules become more stringent. This naturally tends to increase transport costs. Perhaps the most widely known of these is the Sulphur Emission Control Area (SECA), which entered into force on January 1, 2015 with much less problems than what was predicted. This is mainly due to the unexpectedly low oil prices, and subsequently low prices of low-sulphur marine gasoil.

Several other regulatory amendments on e.g. nitrogen oxygen emission, ballast water treatment, and energy efficiency of ships are coming during the next years. Complying with these requires arrangements and involves costs, which the cash-strapped shipping companies are not well prepared for. The next few years will not be easy for the Baltic Sea maritime industry, as no imminent economic recovery, and hence higher demand for maritime and other logistics services seems to be in sight for the region as a whole.

1. Introduction

Demand for logistics services, such as maritime transport and port services, is always derived demand. This means that the actual performance of shipping and ports measured, for example, in tonnes or tonne-kilometres reflects the level of overall economic development. Furthermore, the impact of changes of economic activity – and especially those of merchandise trade – is typically amplified in logistics services, i.e. logistics demand changes more than that of economic activity. Maritime transport in the Baltic Sea is no exception to this general principle.

Export volume of the Baltic Sea Region (BSR) measured in monetary terms has barely reached the pre-crisis level of 2008, and the volume has, in fact, decreased both in 2012 and 2014 compared to the year before (Figure 1). The developments in 2015 and early 2016 have shown no overall improvement despite the growing Swedish and German economies. By contrast, the weakening economy in Russia and lower trade volumes with Russia affect BSR maritime transport significantly, especially for transit and transshipment cargoes.

Figure 1. Annual growth of export value 2006-2014 in the world and the Baltic Sea region (BSR)¹



Source: Ketels and Pedersen 2015; data source WTO 2015.

As a result, the Baltic Sea Region ports² handled about the same cargo volume in 2015 than in 2008. This volume has been around 830 million tonnes per annum. Overall, the BSR maritime and especially seaport market has been stagnant, but some relative changes have taken place between cargo groups (Figure 2). By comparison, the volume of goods transported by sea in the world reached 9,840 million tonnes in 2014 and the global growth rate of maritime transport since 2012 has been around 3 to 4% per annum (UNCTAD 2015).

Using these two values as a proxy, the BSR maritime freight transport comprises about 8.4% of the world total. This is considerably less than the HELCOM estimate from 2009, according to which 15% of global seaborne trade would have taken place in the Baltic Sea. This is not to say that the HELCOM estimate would have been far off³. It rather reflects the fact that the **relative share** of the BSR in trade and also in

¹ Here, the BSR includes Denmark, Estonia, Finland, Iceland, Latvia, Lithuania, Norway and Sweden as countries, and northern Germany, northern Poland and most parts of Russia's Northwestern Federal District (for a more detailed definition, see Ketels and Pedersen 2015, p. 5).

² The definition used by Matczak includes all seaports within the Baltic Sea and the Swedish ports on the west coast. German or Danish ports on the North Sea side, and all the Russian ports outside the Baltic Sea are excluded.

³ As indicated by the two previous and somewhat differing definitions of the Baltic Sea (Region), a word of caution is in place, when different statistical sources are compared. Country-level data includes, for example, all of Germany, Poland and Russia, while regionally (dis)aggregated data on BSR may exclude substantial parts of these three countries. Furthermore, statistics on country-level maritime transport may also differ from statistics that are gathered from individual ports for the following reason. Every tonne or cargo unit, such as a container, that is loaded

maritime transport has, in fact, grown smaller. WTO's trade data shows a similar trend: while the BSR's relative share of world exports by value was around 5.2% in 2005-2008, the corresponding share was around 4.5% in 2014 (Ketels and Pedersen 2015).

Figure 2. Baltic Sea Region seaport market dynamics 2006-2015 in million tonnes of container and all other cargoes handled (left axis), and annual percent change of total traffic (right axis)

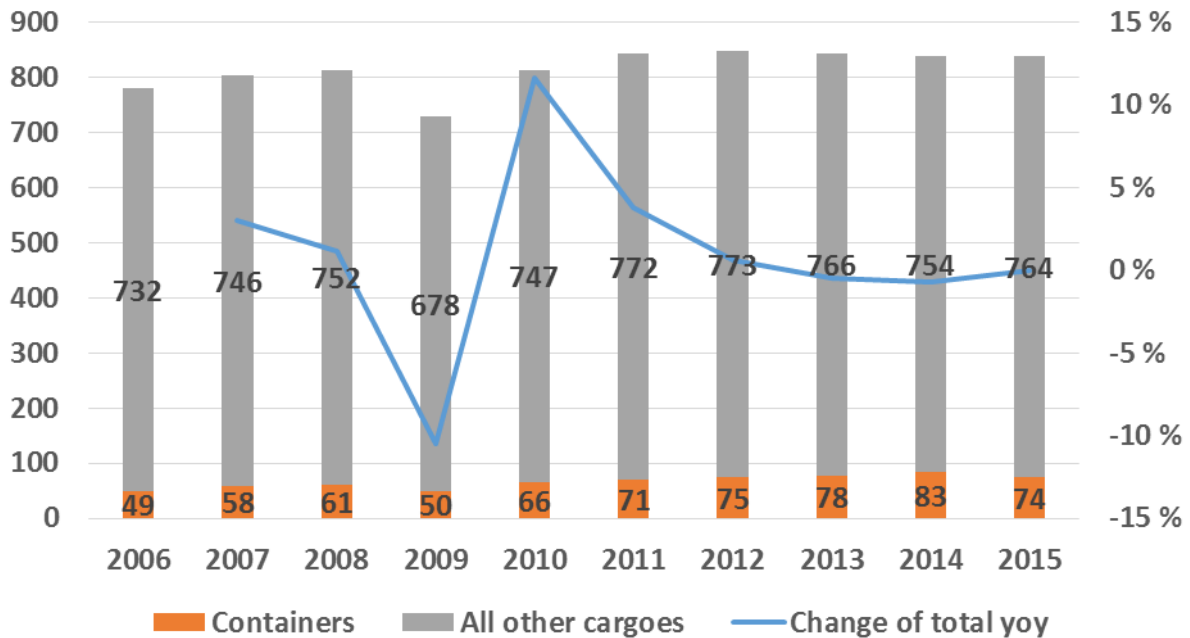

Source: Adapted from Matczak (2016a) and BSR seaport data.

The actual development of maritime traffic in the Baltic Sea is in stark contrast to market estimates made during the past decade. Baltic Maritime Outlook 2006, for example, predicted that intra-regional maritime traffic in the Baltic Sea would grow by +55% from year 2003 to 2020, and the inbound maritime volumes from outside the region would grow by +30%, while outbound volumes would increase by 45% in the same period. The combined **increase** of these three types of flow was predicted at 630 million tonnes, meaning that the overall volume would have reached 1,100 million tonnes. Data from 2015 indicates that barely half of that predicted growth has materialised, and the overall volume is at approximately 830 million tonnes. A more modest prediction was made in the Baltic Transport Outlook 2030 study published in 2012, but also it overestimated the growth. On the other hand, many political and economic events and their impact on transport markets are – and have been – extremely difficult to estimate.

The overall bleak market outlook for shipping companies is evident from Figure 3, which provides the indexed development of worldwide maritime freights for bulk, tanker and container shipping. The dire situation is clear, when you consider that these freights have generally been at similarly low levels since summer 2008.

The corresponding freight levels before the worldwide economic downturn in summer 2008 were

on a ship somewhere (e.g. Port A) will eventually be unloaded somewhere else (e.g. Port B). This means that data of cargo handled in ports is actually counted twice, whereas the cargo is moved from A to B only once. This distinction is not always easy to see in the published statistics.

typically 4 (containers) to 8-10 (dry and liquid bulk) times higher compared to the levels in 2014-2015 (BIMCO 2016; see also UNCTAD 2015a). The persistent overcapacity in most shipping segments and the imbalance of maritime transport demand and supply is the main reason for this situation.

Figure 3. Maritime freight rate developments 2013-2015 for selected types of worldwide shipping; indexed; November 2013 = 100

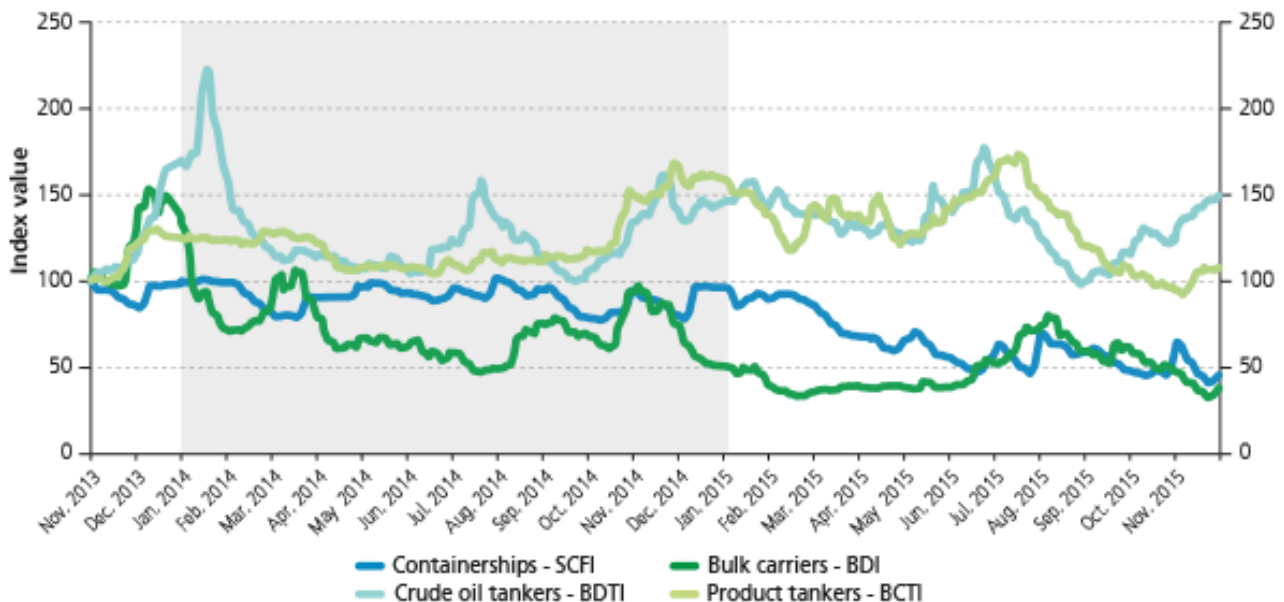

Source: BIMCO (2016); data sources: BIMCO, Baltic Exchange and Shanghai Shipping Exchange.

What is bad news for shipping companies, is good news for shippers, as low freight levels mean low transport costs. But even these record low freight levels do not necessarily generate more transports. The outlook in the maritime world in general, and in the Baltic Sea shipping markets in particular, does not show any signs of imminent improvement for ship owners and operators.

2. Baltic Sea countries as maritime countries and their logistics posture

The Baltic Sea Region countries dependence of shipping and position in the maritime sector varies a lot. By country of ownership⁴, Germany has the world's 4th largest fleet, while Norway ranks 10th and Denmark 13th. By the same measure, Russia is 20th and Sweden 34th, whereas the land-locked Belarus has no merchant marine (UNCTAD 2015a)⁵. Most Baltic Sea countries are also significant providers of a wide range of shipping, maritime industry and shipbuilding services and technology.

The ranking of these countries varies also significantly in other selected shipping, logistics and connectivity indices, which put together provide a useful insight into their differing postures in world trade and logistics.

⁴ Measured as the fleet's DWT size as of January 1, 2015 (UNCTAD 2015a).

⁵ On March 24, 2016, UNCTAD launched a website that provides a two-page basic "Maritime Country Profile" for almost every country in the world – naturally including all the Baltic Sea countries. This repository can be accessed at: <http://unctadstat.unctad.org/CountryProfile/MaritimeProfile/en-GB/004/index.html>

Table 1. Baltic Sea countries' merchandise fleet in 2014 in thousand deadweight tonnes (DWT), and their rankings in selected logistics and connectivity indices

	DWT '000s in 2014 ¹	LPI Rank 2007-2014 ²	LSCI 2015 rank ³	GCI 2014 rank ⁴
Germany	127,273	1	6	9
Norway	61,474	11	131	15
Denmark	42,462	14	23	8
Russia	23,357	94	33	69
Sweden	7,204	6	20	10
Poland	2,809	31	25	43
Finland	2,051	17	88	25
Latvia	1,227	40	145	49
Estonia	462	42	123	51
Lithuania	370	47	114	52
Belarus	n.a.	98	n.a.	97

Sources:

- 1) UNCTAD 2014; DWT is a measure of ships' cargo carrying capacity in tonnes. According to the 'real nationality', which reflects the nationality of the controlling interest(s) of the ship, not the flag of registration of the ships. The total DWT fleet in 'real nationality' terms is about 10% higher for the BSR countries than the fleet by registry.
- 2) Arvis et al. 2014; Appendix 4; LPI = Logistics Performance Index.
- 3) UNCTAD 2015b; LSCI = Liner Shipping Connectivity Index (covers only container shipping connectivity).
- 4) Ghemawat and Altman 2014; GCI = Global Connectivity Index.

The international comparison in **World Bank's Logistics Performance Index (LPI)** looks at six dimensions that capture the most important aspects of countries trade logistics performance, where each dimension is rated on a 5-point scale (Arvis et al. 2014):

1. Customs; efficiency of the customs clearance process.
2. Infrastructure; quality of trade and transport-related infrastructure.
3. International Shipments; ease of arranging competitively priced shipments.
4. Logistics Quality; competence and quality of logistics services.
5. Tracking and Tracing; ability to track and trace consignments.
6. Timeliness; frequency with which shipments reach the consignee within the scheduled or expected time.

The overall index is based on the six dimensions listed above. The LPI is an overall metric of country level supply chain efficiency. It provides an idea where a country stands and a broad indication of problem areas. As shown in Table 1, the Baltic Sea region countries' trade logistics performance range from the 1st of Germany to 98th of Belarus, and the three Nordic countries Finland, Denmark and Sweden are all among the top 10% of the surveyed 166 countries.

UNCTAD's Liner Shipping Connectivity Index (LSCI) is an indicator of each coastal country's access to the

BSR Policy Briefing 1/2016

Global container shipping network⁶. The LSCI is generated from five components that capture the deployment of container ships by liner shipping companies to a country's ports of call:

- the number of ships;
- their total container-carrying capacity;
- the number of companies providing services with their own operated ships;
- the number of services provided; and
- the size (in TEUs) of the largest ship deployed.

The LSCI score of a country is not only determined by its trade volume, but increasingly by its position, i.e. its degree of connectivity, within the global liner shipping network. The country with the highest LSCI scores in 2015 is China, followed by Singapore, Hong Kong (China), Korea, Malaysia, and Germany (6th). The following four Baltic Sea countries assuming ranks 20 to 33 are Sweden (20th), Denmark (23rd), Poland (25th) and Russia (33rd) (see Table 1).

The LSCI comprises only container shipping data. Thus, countries that rely predominantly on ro-ro-shiping (shortsea liner shipping loading trucks and trailers on wheels) typically receive low scores, even when their shipping operations can be quite well developed. Examples of such countries in the Baltic Sea Region are Estonia, Finland and Norway.

A spin-off of the LSCI is the more detailed **Liner Shipping Bilateral Connectivity Index (LSBCI)**, which uses the same underlying container shipping data to study the connectivity of country pairs, hence the name 'bilateral'.

Table 2. Liner Shipping Bilateral Connectivity Index 2015 of Baltic Sea countries (LSBCI)

	Estonia	Finland	Germany	Latvia	Lithuania	Norway	Poland	Russia	Sweden
Denmark	0.28	0.30	0.58	0.21	0.27	0.30	0.50	0.36	0.56
Estonia		0.30	0.35	0.27	0.28	0.26	0.28	0.32	0.29
Finland			0.38	0.27	0.28	0.26	0.32	0.36	0.33
Germany				0.31	0.32	0.35	0.59	0.55	0.64
Latvia					0.26	0.20	0.27	0.29	0.28
Lithuania						0.20	0.28	0.31	0.29
Norway							0.23	0.26	0.31
Poland								0.37	0.53
Russia									0.40
Germany's rank	1st	1st	*)	1st	1st	3rd	1st	9th	1st
Colour scale	< 0.3	0.3-0.49	0.5-0.59	> 0.6	*) The highest BSR country Sweden, 20th				

Source: UNCTAD 2015c; Maximum score (tightest possible connection) = 1.0; Minimum score = 0.0.

⁶ UNCTAD 2015a; UNCTAD 2015b and UNCTAD 2015c; the data is available at UNCTADstat at <http://stats.unctad.org/lsci>

Despite the absence of ro-ro shipping data, which substantially undermines the scores of e.g. Estonia and Finland, the LSBCI provides a useful insight into how tightly – or loosely – Baltic Sea countries are tied to each other by container shipping. It also underscores Germany’s role as the main trading (and container shipping) node in Europe. When considering the intensity of container shipping connections with all countries in the world, Germany ranks first for all other countries in Table 2 except for Norway (Germany ranked 3rd) and Russia (Germany ranked 9th). The tightest connection between any country pair in Table 2 is between Sweden and Germany, whereas container shipping linkages from Lithuania (and understandably from Norway) in the Baltic Sea range tend to be the weakest.

The DHL Global Connectedness Index (GCI) index is composed of a large number of existing globalisation indicators around the world on the movement of goods (trade), people, investments and information. GCI takes a look at the depth of international interactions (of trade, people, investments and information), their geographic distribution (breadth) and their directionality (outward versus inward). Depth measures countries’ international flows relative to the size of their domestic economies. Breadth measures how closely a country’s distribution of international flows across its partner countries matches the global distribution of the same type of flows.

The leading Baltic Sea countries in the overall GCI, which combine depth and breadth measures are Denmark (8th), Germany (9th) and Sweden (10th), while the three lowest ranking ones are Lithuania (52nd), Russia (69th) and Belarus (97th). These correlate rather well with the LPI, for example.

3. Baltic Sea ports

Over the past 10 years, the relative market share of Russian ports has grown from about 17 to 27.5% of the total cargo volumes handled in Baltic Sea ports. The only two other countries, which have been able to grow their market share over the same period are Poland and Lithuania (see Figure 4).

Figure 4. Baltic Sea Region seaport market dynamics from 2006 to 2015 in percentage of the total market

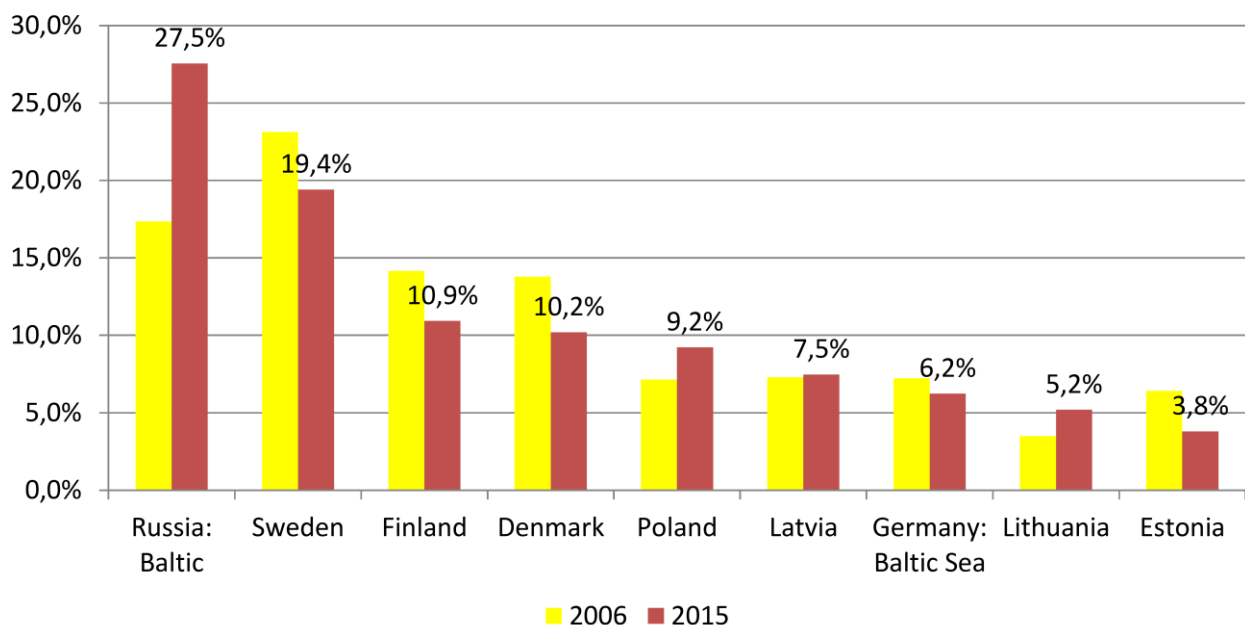

Source: Matczak (2016a).

Since 2011, especially the EU seaports in the Baltic Sea (including Swedish west coast ports) have seen their cargo handling volumes diminish by -3 to -2% year-on-year till 2014, with a further decrease of -1% from 2014 to 2015 (see Figure 2 and Figure 4).

Country-specific differences have been large: for example, Finnish ports witnessed a -7.3% drop in traffic from 81.5 million tonnes in 2014 to 87.9 million tonnes in 2015 (Kauppalehti March 8, 2016). The Polish seaports registered a new record level of turnover of 77 million tonnes in 2015, which was 2.2 million tonnes, or 2.9%, higher than in 2014 (Matczak 2016b). Russian ports in the Baltic Sea have had slight increases at a level of +1 to +3% per annum during the period 2011-2015.

Dynamics at the level of individual ports is naturally even higher. The growth of Russian ports over the past decade, as measured in tonnes, is mainly attributed to the rapidly growing shipments of crude oil and other commodities. Liquid bulk has typically been the cargo type that has been growing in many other Baltic Sea ports, too (see also Baltic Port Barometer 2015). The ports sector is discussed in more detail elsewhere in this report (e.g. Oldakowski 2016)

4. Container shipping developments

The worldwide container shipping market is still very volatile and plagued by substantial overcapacity as well as historically low freight rates (Figure 5). However, the number of containers measured in twenty foot equivalent units (TEU) has been growing globally at an annualised pace of about 6% (CAGR) (Figure 6).

Figure 5. China Containerised Freight Index, March 2014-March 2016. (January 1, 1998 = 1,000)

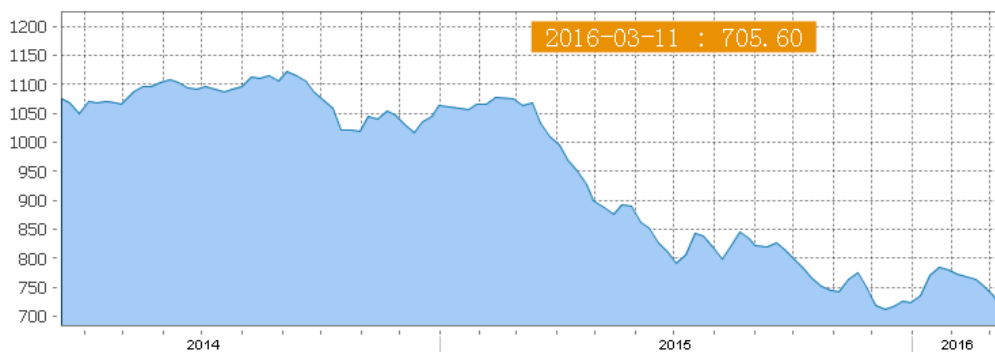

Source: Shanghai Shipping Exchange; available at: <http://en.sse.net.cn/indices/ccfinew.jsp>

In 2014, the volumes on the Asia–Europe and trans-Pacific container trade lanes reversed the downward trend seen since year 2009. Both of these main trade lanes showed robust growth in 2014. However, growth in 2015 and early 2016 has remained vulnerable, however, given continued uncertainties in connection with weaker growth in emerging economies, particularly a potential sharp slowdown in China, as well as concerns about the fragile and uneven recovery in the European Union (UNCTAD 2015a). This affects the Baltic Sea sub-market in a number of ways.

Figure 6. Global containerised trade, 1996-2015 (million TEUs as bars and percentage annual change as solid line)

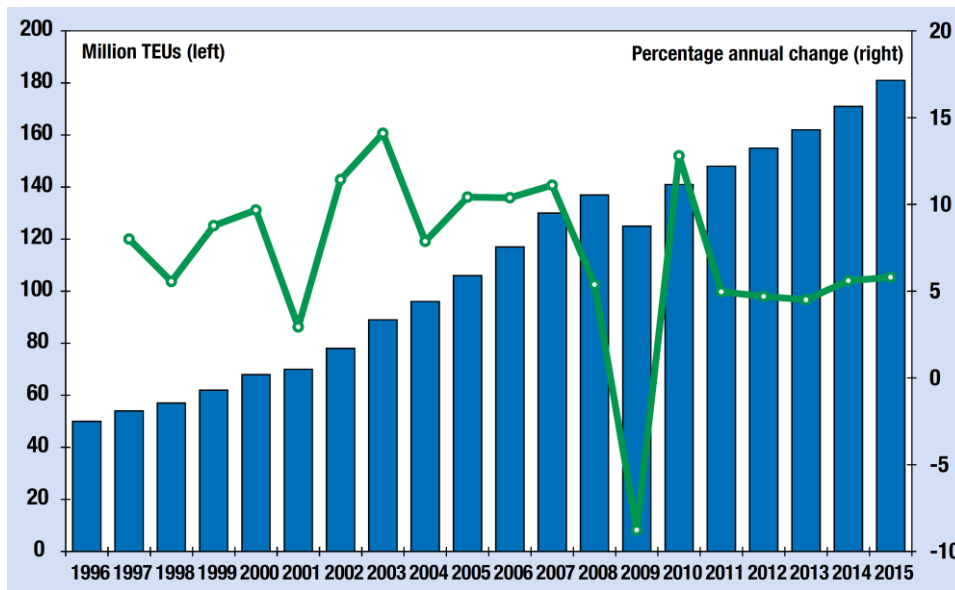

Source: UNCTAD 2015a.

The market dynamics of container shipping in the Baltic Sea is illustrated in Figure 7. It shows that the container sub-market in the Baltic Sea was growing roughly at pace with the worldwide market from 2010 until 2014, but suffered a severe downturn in 2015. The decline is evident in both containerised tonnes and in the volume of TEUs transported by sea.

Hence, the Baltic Sea TEU volumes in 2015 were almost 13% lower than in 2014 despite 15 to 20% lower container freight rates compared to year 2014. In addition, there is a substantial imbalance in containerised cargo flows: empty containers account for approximately 25% of traffic.

Figure 7. Container volumes in Baltic Sea Region seaports 2006-2015 in 10 million tonnes of containerised cargo and in millions of TEU handled

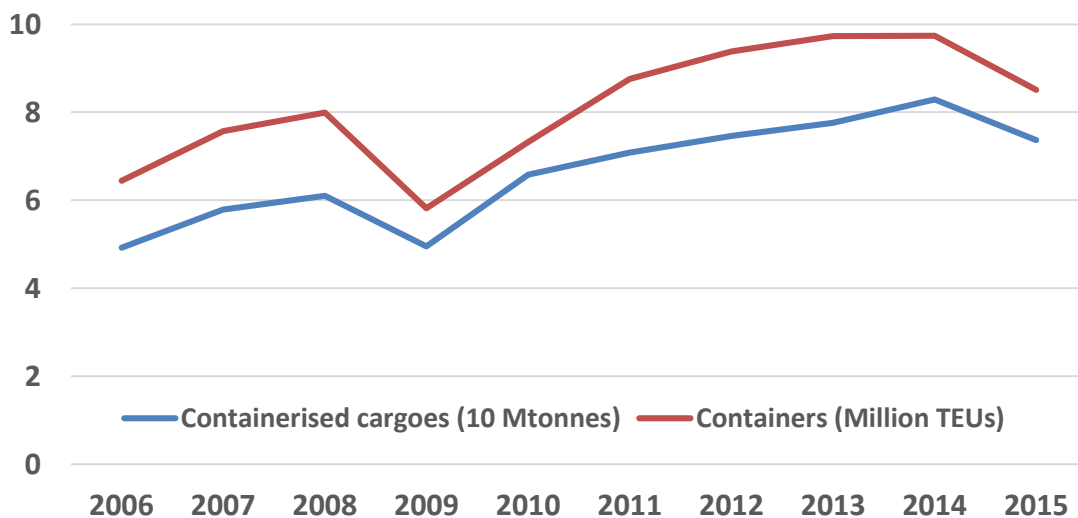

Source: Adapted from Matczak (2016).

Figure 8. Top Baltic Sea container ports 2015 in millions of TEU handled (left axis), and the percentage change from 2014 to 2015 (right axis)

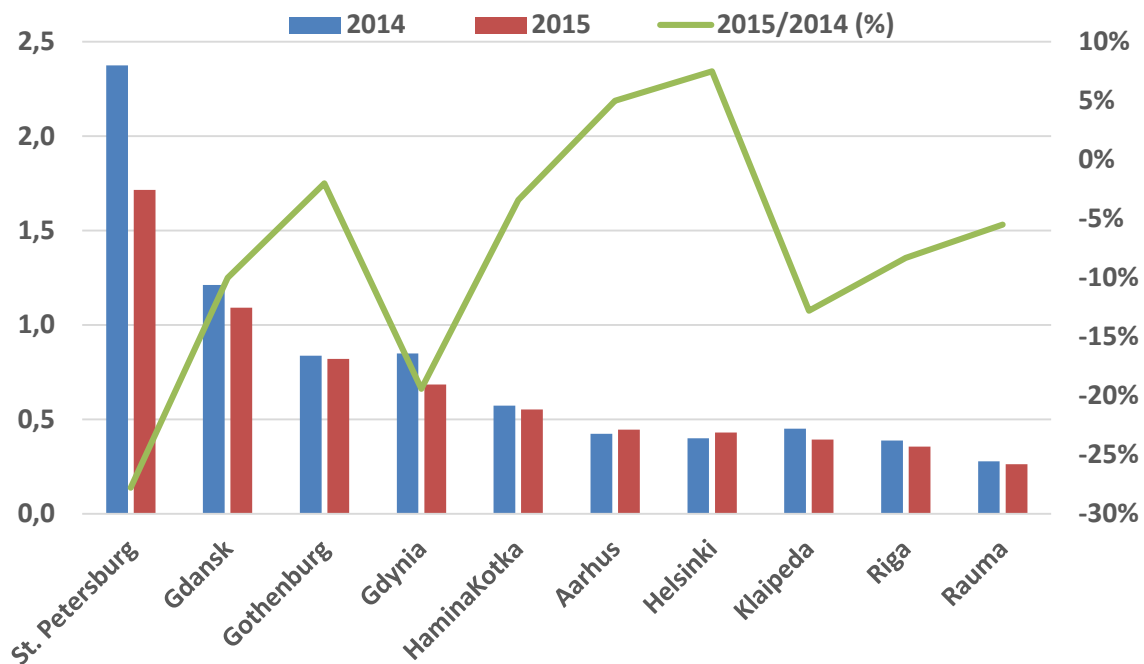

Source: Adapted from Baltic Transport Journal 1/2016, p. 33.

This was caused by a combination of slow economic growth in the region compounded by the rapidly weakening demand of manufactured goods in Russia⁷. This is vividly illustrated in Figure 8, which shows the latest available data of the largest Baltic Sea container ports. The volumes in St. Petersburg, Russia's main container port, dived dramatically by almost 28% from 2014 to 2015. All other container ports also lost traffic, except for the increases in Aarhus (+5%) and Helsinki (+7.5%).

5. Key regulatory developments and their impact on Baltic Sea shipping

The maritime transport sector has recently been and will be subject to substantial regulatory changes that are mainly motivated by environmental reasons. Many of these are seen by shipping companies as complicated, and often difficult to control once enforced. They generally involve additional costs to comply with the more stringent emission or other rules, which tends to increase the pressure to increase transport costs. The main concurrent or near-future regulatory amendments in shipping include, but are not limited to the following:

- **Sulphur Emission Control Area (SECA)**; Amendment to Annex VI of IMO Marpol Convention; sets strict sulphur emission limits to ships at sea. Entered into force January 1, 2015, and covers in Europe all of the Baltic Sea, and most part of the North Sea.
- **MRV**: Rules for the accurate **monitoring, reporting and verification** of carbon dioxide (CO₂)

⁷ This data refers to the Baltic Sea ports, but excludes the German North Sea ports as well as the Russian ports outside the Baltic Sea. If the country-level data were used including these other German and Russian ports, the total container port throughput in these countries was over 30 million TEUs in 2014, according to UNCTAD 2015 a. Thus, the more limited definition shows 3.5 times less cargo than the country-level data.

emissions and of other relevant information from ships arriving at, within or departing from ports under the jurisdiction of a Member State, in order to promote the reduction of CO₂ emissions from maritime transport in a cost effective manner⁸. To enter into force in the EU on January 1, 2018.

- **Ballast waters:** International Convention for the Control and Management of Ships' Ballast Water and Sediments (**BWM**) by IMO⁹, which will mandate on disposal of ballast waters of ships.
- **Discharge of cargo hold washing waters;** Bulk cargo hold wash water discharge and cargo declarations under MARPOL Annex V (IMO).
- **Energy Efficiency Index (EEDI)**¹⁰ that limits the engine power of ships, and affect especially ice-strengthened ships needed in ice-infested waters.
- **Nitrogen oxide emission control areas (NECA)** by IMO¹¹; for new ships built after January 1, 2016.

The entry into force of the SECA areas passed without a massive devastating effect on shipping, which the industry was predicting, or fearing to happen. This is mainly due to the unexpectedly low oil prices, and subsequently low prices of low-sulphur marine gasoil (LSMGO; see Figure 9).

Figure 9. Rotterdam price indications of Low-Sulphur Marine Gas Oil (LSMGO) at Rotterdam from March 2015 until March 2016 in US dollars per metric tonne



LSMGO (Low-Sulphur Marine Gas Oil) is Max 0.10% Sulphur Distillate Complying with 2015 ECA Regulations

Source: Ship & Bunker at <http://shipandbunker.com/prices/emea/nwe/nl-rtm-rotterdam#LSMGO>

Approximately 1,500 ships are exclusively in traffic within the Baltic Sea, which are directly affected by the SECA regulation (Rozmarynowska-Mrozek 2016). Also ships occasionally in these waters are subject to the SECA regulation; Gritschenko (2016) cites that during 2014, 8,570 merchant vessels could be identified trafficking in the Baltic Sea.

On the other hand, some ship owners – especially those operating ro-ro ships and ferries – have installed

⁸REGULATION (EU) 2015/757 OF THE EUROPEAN PARLIAMENT AND OF THE COUNCIL of 29 April 2015.

⁹<http://www.imo.org/en/About/Conventions/ListOfConventions/Pages/International-Convention-for-the-Control-and-Management-of-Ships'-Ballast-Water-and-Sediments-%28BWM%29.aspx>

¹⁰<http://www.imo.org/en/MediaCentre/HotTopics/GHG/Pages/default.aspx>

¹¹<http://www.imo.org/en/OurWork/Environment/PollutionPrevention/AirPollution/Pages/Nitrogen-oxides-%28NOx%29-%E2%80%93-Regulation-13.aspx>

BSR Policy Briefing 1/2016

so-called scrubbers on their ships; approximately 73 such ships existed at the end of 2015 in the EU SECA area (Rozmarynowska-Mrozek 2016). Scrubbers allow ships to use marine fuel oils with much higher level of sulphur than the 0.1% level allowed in the SECA region. These retrofitted scrubbers are large pieces of equipment, which cost several million US dollars per ship, and it is not certain that the currently low freight levels will allow these investments costs to be recovered.

The other listed regulatory amendments are coming into force mainly in 2016-2018, which means that several such changes are expected in a relatively limited period of time. Complying with these requires series of arrangements, such as extraordinary dockings or instalments, and involves costs, which the cash-strapped shipping companies are not well prepared for. The next few years will not be easy for the Baltic Sea shipping industry.

References

- Arvis, J-F, Ojala, L., Shepherd, B. and D. Saslavsky, Busch, C. and A. Raj., 2014, *Connecting to Compete 2014: Trade logistics in the global economy: the logistics performance index and its indicators*. The World Bank, 2014.
- Baltic Maritime Outlook 2006 (2006) Goods flows and maritime infrastructure in the Baltic Sea Region; available e.g. at: <http://www.sjofartsverket.se/pages/1114/Baltic%20Maritime%20Outlook%202006.pdf>
- Baltic Port Barometer 2015, Baltic Ports' Outlook 2015, Centre for Maritime Studies, University of Turku, available at: <https://www.utu.fi/en/units/cms/projects/marketreview/Pages/home.aspx>
- Baltic Transport Journal 1/2016.
- Baltic Transport Outlook 2030 (2012) Available at: <http://www.baltictransportoutlook.eu/>
- BIMCO (2016) The shipping market in 2015 and looking forward, available at: https://www.bimco.org/Reports/Market_Analysis/2016/0104_Reflections2016.aspx
- Ghemawat, P. and Altman, S.A. (2014) "DHL Global Connectedness Index 2014," Deutsche Post DHL, November 2014; available at: http://www.dhl.com/content/dam/Campaigns/gci2014/downloads/dhl_gci_2014_study_low.pdf
- Gritsenko, D. (2016) Shipping and environmental governance in the Baltic Sea region, BSR Policy Briefing 1/2016
- HELCOM (2009) Overview of the shipping in the Baltic Sea, available at: http://www.helcom.fi/stc/files/shipping/Overview%20of%20ships%20traffic_updateApril2009.pdf
- Kauppalehti (2016) Satamien kilpailu kiristyy, Appendix "Logistiikka", (Kauppalehti is a Finnish business daily) p. 8-9, March 8, 2016
- Ketels, C. and Pedersen, H. (2015) 2015 State of the Region Report™, The Top of Europe – Striving for Direction in a Complex Environment, Baltic Development Forum, Copenhagen
- Matczak, M. (2016a) "Baltic Container Market in recent years – what have we learnt?" Presentation at Transport Week 2016, Sopot, March 8-10, 2016
- Matczak, M. (2016b) Polish seaports in year 2015, March 2016, Port Monitor, Gdansk
- Oldakowski, B. (2016) Ports of the Baltic Sea, BSR Policy Briefing 1/2016
- Rozmarynowska-Mrozek, M. (2016) EU Sulphur Directive – a year after the entry into force. How ship-owners are meeting new regulation, BPO Meeting, Transport Week, Sopot, March 8, 2016
- Ship & Bunker at <http://shipandbunker.com/prices/emea/nwe/nl-rtm-rotterdam#LSMGO>
- UNCTAD, 2014, Review of Maritime Transport; at: http://unctad.org/en/PublicationsLibrary/rmt2014_en.pdf
- UNCTAD, 2015a, Review of Maritime Transport; at: http://unctad.org/en/PublicationsLibrary/rmt2015_en.pdf
- UNCTAD 2015b, Liner Shipping Connectivity Index (LSCI) Available at: <http://stats.unctad.org/lsci>
- UNCTAD 2015c, Liner Shipping Bilateral Connectivity Index (LSBCI) Available at: <http://unctadstat.unctad.org/wds/TableViewer/tableView.aspx?ReportId=96618>

Sea transport capacity of Finland

Bo Österlund

Has the security of supply of Finnish seaborne transport been implemented in a secure, effective and acceptable way?

Executive summary

In addition to descriptions of history, statistics provide an important source of information for examining the development of foreign seaborne transport, assessing sea transport volumes and the available tonnage, evaluating the efficiency of sea transport systems, and identifying potential bottlenecks. They also play an important role in recognising the need for change and developing future seaborne trade. The more dependent we are of our sea connections, the more important it is to create and maintain an anticipatory transport system that enables the use of different alternatives and rapidly adapts to various situations. As the world changes, transport systems also evolve based on supply and demand and the terms they dictate.

The main source materials used in this article include official foreign seaborne trade and shipments statistics that have been supplemented with comments from shipping experts, Finnish foreign seaborne transport merchant vessel lists, foreign seaborne transport merchandise volumes, and the volume of seaborne trade in tonne-nautical miles supplemented with vessel information provided by shipping companies.

This article examines the total transport and performance capacity of Finland's merchant fleet by taking into account the transport capacity of individual merchant vessels and the deadweight cargo capacity (dwcc) concept. The flows of goods in foreign seaborne trade are mainly examined based on the Finnish Transport Agency's (FTA) division into five different commodity groups. In order to be able to carry out a performance analysis, the freight volumes are examined using the international 'Big Trio' framework that includes liquid bulk (LB), dry bulk (DB) and general cargo (GC).

The article begins by assessing the current seaborne trade situation in Finland. Since the heyday of Finnish seaborne trade in the 1990s, the share of transport carried out by Finnish vessels has decreased from over 50% to around 43% in imports and to below 23% in exports. The average, 33%, can only be used for arithmetic purposes. Each commodity group is examined separately and its significance to the functioning of society and critical imports is assessed to determine the level of security of supply.

The article also examines what would be required of the Finnish tonnage if all imported and exported goods were transported just using Finnish vessels. This discussion provides insights into the requirements that need to be set for the capacity, composition and structure of the Finnish merchant fleet.

1. Finland is dependent on sea connections and seaborne goods traffic

As a peninsula jutting into the Baltic Sea, Finland is more dependent on seaborne goods traffic than most of its neighbouring countries. In 2014, Finnish foreign trade transport amounted to 103 million tonnes of goods, and 83% of this amount was transported by sea. In other words, merchant vessels carried 88 million tonnes of goods. The overseas imports per capita figures also reflect our dependence on imports. The worldwide merchant fleet transport approximately 1.3 tonnes of cargo for every person in the world (UNCTAD 2015). On average, the Nordic countries annually import 7.9 tonnes of goods per capita by sea. Finland annually imports 8.7 tonnes and exports 7.6 tonnes, and Sweden imports 7.8 tonnes and exports 6.4 tonnes (Stopford 2013; Trafikanalys 2014; Liikennevirasto, Ulkomaan Merikuljetukset 2014; Österlund 2014; Transportstyrelsen 2015). Reference country Japan imports 7.5 tonnes per capita per year, while North America imports 3.8 tonnes, China 1.5 tonnes, South America 0.6 tonnes and Africa 0.2 tonnes (Stopford 2013).

Finland's security of supply is grounded in well-functioning markets and a competitive economy. In normal conditions, the commodity flows of foreign trade are transported on commercial terms (NESA, National Emergency Supply Agency 2016).

We are accustomed to regular sea connections. In good times, there are plenty of goods in shops, the raw materials and components required by industry and critical infrastructure protection are in the right place at the right time, and industrial plants are kept running using domestic and imported energy.

The markets, however, may not always be sufficient to maintain society's fundamental economic and other critical functions amid disruptions and emergencies. For this reason, diverse security-of-supply measures are employed to ensure the continuity of national critical infrastructure and services under all circumstances. Lun, Lai and Cheng referred to Coyle et al. (2000) *"The shipping business uses the market mechanism to regulate supply and demand. Demand for freight transport is determined by demand for physical commodities in a given location. Because of the uneven distribution of natural resources and specialisation of production, some areas experience an oversupply of certain commodities, whereas other areas suffer from a deficit. This geographic imbalance gives rise to the fluctuation in demand for freight transport"* (Lun, Lai and Cheng 2010, p. 17).

However, the markets may not be sufficient to uphold the basic economic and technical functions of society in the event of severe disruptions or emergencies. This is why security of supply measures (CIP, Critical Infrastructure Protection) are taken to prepare so that functions vital to society can be maintained at a level as close to normal as possible, even in such circumstances.

One of the legends of Finnish seaborne trade was born on Tähtitorninmäki in Helsinki two days after the Winter War broke out on 2 December 1939. The event was witnessed by reservist Major Väinö Vartiainen, who was in charge of the headquarters' fuel and lubrication department that had been established the same autumn (Etelämäki 2005, p. 257). Vartiainen had a grandstand view of the Laajasalo oil port where a Shell tanker carrying oil products (aviation fuel) first floated along Kruunuvuorenselkä as normal, stopped suddenly, began moving again and then turned back at Kustaanmiekka sound and returned to the open Gulf of Finland. The captain of the tanker was no doubt aware of the bombings that had taken place in Helsinki on the first day of the Winter War on 30 November 1939 and on 1 December 1939 (Pesonen 1985, p. 111). Vartianen could only watch as the ship and its cargo returned to sea and eventually disappeared into the horizon (Saastamoinen 2008, pp. 16-17).

Despite this unlucky event, oil imports did not cease at any point during the Winter War. This would

probably not have been possible if international oil companies had not established their operations in Finland in the latter part of the 19th century (Saastamoinen 2008, p. 17).

During the war, the problem was that foreign oil tankers did not dare or want to take the risk of travelling to Finnish ports as the war had already reached the Baltic States. As a result, oil tankers unloaded their cargo at ports in Norway and Sweden, and Finnish motor engine-driven distribution tankers (Josefina Thorde and Masut III) equipped for travelling through ice then carried the oil to Finland. Finland had seven steam-driven ice-class merchant vessels and 6 motor engine-driven vessels for the transport of bulk cargo (Suomen Kauppalaivasto 1939).

The Finnish merchant fleet suffered major losses in the Second World War. At the beginning of the year 1939, our merchant fleet tonnage included 861 vessels whose total capacity in gross register tonnage (grt; 1 grt = 2.83 m³) was some 600,000 (Suomen Kuvalehti 1950). New tonnage regulations adopted by the International Maritime Organization (IMO) entered into force in 1982, and gross and net register tonnages were replaced by gross tonnage and net tonnage. Gross tonnage and net tonnage are logarithmic functions that provide unitless numerical values. They do not refer to weights (tonnes). This is a constant source of translation errors as the English word 'tonnage' is translated using the Finnish word for 'weight tonne'. In the budget proposal for the year 2016 (28 September 2015), the Finnish Government states that the estimated tonnage of the 114 merchant fleet vessels covered by the subsidy for international traffic is estimated approximately 1.6 million tonnes. Weight tonnes should not be used in this context.

2. The global market opens, consumer demand increases, and industry needs raw materials and energy

During wartime, the Finnish merchant fleet ensured the continuity of critical import. Finland was dependent on a very fragile but all the more important 'umbilical cord', sea transport. The vessel losses suffered during the Second World War were made up for by 1952 when the global merchant fleet grew to be greater than before the war (Suomen Kuvalehti 1950, pp. 46–47).

After the Second World War, seaborne trade volumes increased as a result of Finland's improved standard of living, the increased demand for fossil fuels, the increase in domestic consumption, and industry's growing need for raw materials. Finland's sea traffic grew steadily after the Second World War: according to NBN (National Board of Navigation) statistics, 19.4 million tonnes of goods were transported by sea in 1960 and Finnish vessels accounted for almost 50% of this amount. Seaborne import volumes were smaller than export volumes up until the early 1960s, mainly because of Finland's major raw material exports. The significant growth in import volumes during the 1960s was due to the large increase in the consumption of oil products. Fuels accounted for 20% of imports in 1955, 31% of imports in 1960 and over 50% of imports in 1970. The Finnish exchange of goods achieved its 30-million-tonne milestone in 1969. At this point, the share of transport carried out by Finnish vessels had dropped to less than 50% (Table 1).

According to National Board of Navigation (NBN) statistics, 84% or 49.4 tonnes of the seaborne transport of goods between Finland and other countries took place by sea in 1980. Only around 40% of the sea transport was carried out by Finnish vessels. What is more, Finnish vessels only accounted for slightly over 38% of the total transport volume of 112,372 million tonne-nautical miles. This means that Finnish vessels either retrieved their cargo from closer destinations than foreign vessels or delivered their cargo to nearby ports. In spring 1980, shipping strikes that lasted almost two months played an important role in decreasing the share of sea transport carried out by Finnish tonnage.

Table 1. Volumes of goods in foreign seaborne trade and the share of transport and tonne-nautical miles performed by Finnish vessels

YEAR	TOTAL VOLUME MILLION TONNES (MT); SHARE OF FINNISH VESSELS (%)		IMPORTS MILLION TONNES (MT); SHARE OF FINNISH VESSELS (%)		EXPORTS MILLION TONNES (MT); SHARE OF FINNISH VESSELS (%)		SHARE OF TOTAL TONNE- NAUTICAL MILES (TNM) PERFORMED BY FINNISH VESSELS % / MILLION TNM	
1980	49.4 MT	42.7%	31.5 MT	45.8%	17.9 MT	37.1%	38.6%	43,154
1990	58.9 MT	34.6%	34.8 MT	37.6%	24.0 MT	30.2%	16.5%	13,043
2000	80.6 MT	40.1%	41.1 MT	47.2%	39.5 MT	32.8%	22.3%	19,653
2005	89.6 MT	29.9%	49.8 MT	38.8%	39.9 MT	18.8%	17.6%	94,740
2008 ¹	102.4 MT	31.0%	58.1 MT	39.1%	44.3 MT	20.3%	16.9%	112,372
2010	93.3 MT	30.7%	51.5 MT	41.1%	41.8 MT	17.9%	14.7%	112,596
2012	93.2 MT	33.8%	49.3 MT	45.3%	47.0 MT	21.7%	14.3%	124,372
2014	96.1 MT	33.0%	48.0 MT	43.5%	48.2 MT	22.5%	17.5%	106,590

Sources: NBN (National Board of Navigation); Shipping between Finland and Foreign Countries 1980, 1990; FMA (Finnish Maritime Administration), 2000, 2005; Official Statistics of Finland; FTA; Statistics from the Finnish Transport Agency; Statistics on International Shipping 2010, 2012, 2014.

In 1990, 85% of the seaborne transport of goods between Finland and other countries took place by sea. Foreign seaborne trade through Finnish ports amounted to 58.9 million tonnes. In ten years, the transport of goods by sea had increased by 21.1%.

However, the share of transport carried out by Finnish tonnage had decreased by 15.0 percentage points since 1980. In 1990, Finnish vessels accounted for 34.6% of all transport by sea, and the share of tonne-nautical miles covered by foreign vessels was growing. The volume of Finnish transport in tonne-nautical miles decreased in the 1980s, but began to grow again in 1990.

3. Setting targets for security of supply

In a government decision from 1995 (GVD 1440/1995), the section concerning the targets for security of supply and transport states that the main focus is on securing sea transport. According to the decision, a sufficient ice-class tonnage that has been registered in Finland should also be maintained in order to secure foreign trade transport. The technical functions of ports and vessel maintenance should be secured so that they can be maintained at normal level for a period of 12 months. The targets set for energy supply were demanding. According to the decision, Finland should be prepared to maintain the production capacity of heat and electricity and the distribution and transmission network at a basic supply level for 12 months in a situation where import goods were not available. The aim was to have a reserve of imported fuels that was equivalent to the average 7-month Finnish consumption. Government reserve supplies had to contain enough oil products to meet the 4-month average consumption of oil and natural gas. The out-flagging of the Finnish tonnage had increased in the 1990s. As it was seen as a major threat, it also affected the targets of the security of supply decision (Kananen 2011).

Finland's foreign seaborne trade saw a 74% increase between 1990 and 2008. The growth was rather steady, but there were also a couple of exceptional years. In 1994, seaborne trade volumes increased

¹ The level in 2008 that was defined as the risk threshold for our tonnage in a government proposal (148/2008).

for several reasons: Finland was recovering from the recession and exports to Russia were being replaced by exports to the west. Oil transport and the imports of raw materials also saw a significant rise. The previous recession did not reduce Finland's foreign sea transport volumes as the recession was more domestic-market-based (NBN 2009).

Seaborne trade attained a new all-time high in 2000. In the case of imported coal and mineral oil, the share of transport carried out by Finnish vessels was very high. The main reason for the drop in seaborne trade volumes in tonne-nautical miles in the 1980s was the major decrease in the amount of crude oil imported from the Middle East (NBN 2000).

The purpose of the detailed specification of deadweight tonnage and gross tonnage is to determine the capacity or dead weight tonnage of Finland's merchant vessel fleet and to provide a basic value for determining the total cargo carrying capacity of the fleet. Examining this value provides information about the development of the Finnish merchant fleet's cargo carrying capacity, which has been decreasing since the risk threshold year 2008.

According to the Finnish Maritime Administration (FMA 2000) merchant fleet list from 2000, Finland had 106 vessels in foreign sea traffic, and their combined deadweight tonnage was 1.1 million tonnes. This number of Finnish vessels and amount of cargo capacity was able to transport 32.4 million tonnes of the year's total seaborne transport volume which amounted to 80.6 million tonnes. In other words, Finnish vessels transported 40% of the total amount of goods. The seaborne trade between Finland and other countries mainly took place in the Baltic Sea and the North Sea region. In 2000, 62.8% of imports came from Baltic Sea ports (cf. 65% in 2014) and 33.4% from other parts of Europe, mainly from ports on the coasts of the North Sea. The destinations of Finnish exports were slightly more varied: 38% of goods went to ports in the Baltic Sea region (36% in 2014) and 50.3% to other European ports.

In 2002, the Finnish merchant vessel list included 129 merchant vessels with a deadweight tonnage of 1.1 million tonnes. This number of Finnish vessels and amount of cargo capacity was able to transport 29.5 million tonnes of the year's total transport volume which amounted to 86.9 million tonnes. This means that Finnish vessels transported 33.9% of the total amount of goods. The same year, a government decision (GVD 350/2002, 2.2. Transport System) on security of supply stated the following: *"In order to secure foreign trade transport, a sufficient ice-class vessel fleet and air transport fleet shall be maintained. The infrastructure and essential logistic chains shall be secured."* (Table 2).

In 2005, there was a clear decrease in foreign sea transport compared to the volumes of the past couple of years. The decrease was caused by paper industry lockouts.

In a government decision from 2008 (GVD 539/2008, 2.3.), temporary import disruptions were considered the most severe threat to security of supply. The concept of security of supply was also extended to cover severe disruptions in normal conditions. General time targets were abandoned in the securing of critical infrastructures. According to the decision, contingency activities in the transport sector focus on securing sea transport and the transport needed to secure the supply of basic foodstuffs and energy. The decision further determines that in order to secure foreign trade transport *"a sufficient ice-class vessel fleet and air transport fleet shall be maintained. Finland shall also have a sufficient icebreaker fleet sailing under the Finnish flag to assist sea traffic and secure shipping in winter. The domestic self-sufficiency of Finnish transport shall be secured in all circumstances. The functioning of fuel transport and other critical transport requiring special equipment and skills shall be secured."*

Table 2. Deadweight tonnage and gross tonnage as indicators of the transport capacity of Finland's merchant fleet from 1980 to 2014

YEAR	NUMBER OF VESSELS	DWT TONNAGE (TONNES)	GROSS TONNAGE (UNITLESS)	SHARE OF FOREIGN TRANSPORT (%)
2000	106	1,106,399	1,057,943	40.1%
2005	115	1,083,321	1,371,368	29.9%
2008	120	1,160,371	1,435,571	31.0%
2010	113	1,093,943	1,329,311	30.7%
2012	116	1,083,202 ² 1,269,994	1,633,781	33.8%
2013	111	783,365 ³	1,474,041	33.8%
2014	108	776,353 ⁴ 939,273	1,522,643	33.0%
Forecast for the year 2016 from the government budget proposal GVP 28.9.2015	114		1,635,000 ?	

Sources: FMA (Finnish Maritime Administration); Finnish Merchant Fleet Statistics 2000, 2005, 2008, 2010; Trafi Publications; Finnish Merchant Fleet Statistics 2012, 2013, 2014; Merenkuluntuet@Liikennevirasto.fi 2000, 2005, 2008, 2010, 2012, 2014; Suomen Varustamot ry, 2008, 2012, 2014.

In 2008, the 'risk threshold' merchant vessel list included 120 vessels with a deadweight tonnage of 1.2 million tonnes, and this cargo capacity registered in Finland was used to transport 31% of the total transport volume of 102.4 million tonnes. At the time, the Finnish merchant fleet included 3 passenger ships, 12 ro-ro (roll-on/roll-off) passenger ships, 31 ro-ro cargo ships, 7 dry bulk ships, 36 other dry cargo ships, 11 tankers and 20 other vessels (mainly tugboats).

² The dwt value for the year 2012 provided by the Finnish Transport Safety Agency Trafi does not include the dwt values of 23 vessels (of which 9 are tugboats). The Finnish Register of Ships Act (512/1993) does not require operators to report this value, which is why it is not possible to compare deadweight tonnage or merchant fleet cargo capacity in different years based on official statistics. According to the sea transport security of supply report from 2014 that is based on statistics from 2012, the deadweight tonnage of the missing vessels would amount to 1,083,202 tonnes. When this value is used, the total deadweight tonnage for 2012 is 1,269,994 tonnes.

³ The Trafi statistics from 2013 reveal that the number of vessels has decreased by 5 compared to the previous year. These vessels include 2 ro-ro ships and 3 other dry bulk vessels. The gross tonnage decreased by 159,740. In total, the loss of 5 vessels would mean a 486,629 tonne reduction in deadweight. This would mean a 97,000 tonne reduction per vessel. Based on this analysis, there is reason to assume that the total deadweight tonnage for 2013 is much bigger than has been reported (cf. the year 2014).

⁴ The Finnish Merchant Fleet Statistics published by Trafi is available for the year 2014, but without displacement, dwt. According to the data on merchant shipping subsidies maintained by the Finnish Transport Agency, the deadweight tonnage is 776,353 tonnes. The total deadweight tonnage for 2014 has been calculated by adding the figure taken from the Finnish Transport Agency list (31 December 2014) to the deadweight tonnage information provided by the Finnish Shipowners' Association and Finnish shipping companies. This information covered 18 vessels and amounted to 159,920 tonnes. Tugboats have not been taken into account in the deadweight tonnage calculation. According to the merchant vessel statistics for the year 2014, the total deadweight tonnage of 108 vessels is 989,129 tonnes. The dwt values of 16 tugboats are not included in this figure. The list maintained by the Finnish Shipowners' Association includes 97 vessels with a combined deadweight tonnage of 1.0 million tonnes and gross tonnage of 1.5 million.

4. Determining a risk threshold for sea transport performance

The year 2008 is a **milestone and zero point in the sufficiency analysis** of our merchant fleet. The government proposal for the Act on Enhancing the Competitiveness of Ships Engaged in Sea Transport (GVP 148/2008, p. 3.1.) states the following: *“The need for a domestic merchant fleet is emphasised in remote countries like Finland where foreign trade is dependent on sea transport across the Baltic Sea. Security-of-supply aspects alone require Finland to have a sufficient domestic tonnage. However, the size and structure of the necessary fleet has not been determined. The general opinion is that **the current tonnage is close to the risk threshold from the point of view of security of supply.**”*

Thus, the government proposal determined the level of our foreign seaborne trade merchant fleet in 2008 as a risk threshold. This risk threshold and reference value was 1.1 million tonnes (dwt). Finnish vessels accounted for 18,990 million tonne-nautical miles (16.9%) of the total 112,372 million tonne-nautical miles in 2008.

The Finnish Security and Defence Policy 2009 report (Suomen turvallisuus- ja puolustuspolitiikka 2009, p. 85) states that *“Transport operations that are vital to Finland shall be safeguarded in all conditions. Sufficient transport capacity must be under Finnish control or available to Finland so as to manage the necessary foreign trade and vital transport services.”*

The Finnish Critical Industries, Maritime Vulnerabilities and Societal Implications report (Yliskylä-Peuralahti et al. 2011) presents the infrastructure and transport routes which are critical for maintaining security of supply in Finland. As a concrete example of a transport disruption the report analyses the consequences of the stevedore strike at public ports which lasted from 4 March to 19 March 2010. The strike stopped approximately 80% of the Finnish foreign trade. As a result of the strike, Finnish companies could not export their products and/or import raw materials, components, spare parts or other essential supplies. The Finnish society as a whole is very dependent on imports of energy, various raw materials and other supplies needed by different industries. From a security-of-supply perspective, attention should be paid to finding ways to decrease import dependency and ensuring that companies in critical industries can ensure the continuity of their operations (Ibid).

The report shows that in addition to being dependent on imported energy, Finland is dependent on imported pesticides (100%), fertilisers (50%) and soya protein (70%) in the food sector, on imported kaolin (70%) in the forestry and construction industry, and on imported basic chemicals, crude oil (100%) and rubber (100%) in the chemicals industry. Our technology industry is also dependent on enriched iron ore (100%). Over 60% of Finnish imports consist of raw materials and unrefined goods that are used by the domestic market or refined for export purposes.

According to the report, a disruption in seaborne trade would cause energy production to be interrupted in 2-3 days. In the food industry, the time window ranges from 2-3 days to 2-3 weeks depending on how perishable the products are. In the chemical industry, production would be interrupted in 2-9 days and in the forestry industry in 12 hours to 2 days (the limiting factor is the storage capacity at ports as paper cannot be stored outdoors). The technology industry would have to interrupt its production in 2-3 days. In the worst case scenario, Finland would be lacking raw materials, semi-finished goods and spare parts within a couple of days after a disruption in sea transport. The wheels of society would not keep running, or at least they would run very slowly.

In 2012, Finnish foreign trade transport amounted to around 99 million tonnes, of which seaborne trade accounted for some 82.3 million tonnes, excluding (7 million tonnes) transit-transport (83%) and land transport for slightly less than 12 million tonnes. When measured in tonnes, our seaborne foreign trade

was still in deficit and our dependence on imports on the rise (Finnish Customs 2014).

According to Finnish Transport Safety Agency Trafi, in 2012 the Finnish merchant fleet included 116 merchant vessels with a deadweight tonnage of 1.1 million tonnes. When the deadweight tonnage data of the 23 ships not included in the statistics are taken into account, the total capacity increases to over 1.3 million tonnes. In normal conditions, Finland's domestic tonnage was able to transport 67% of the total amount of imported crude oil and oil products. The Finnish fleet covered this transport volume by performing one round trip per month. If all the imported crude oil and oil products were transported using domestic vessels, 17 round trips would be needed per year. The location of the port from which the products are retrieved naturally affects the time required for one round trip. As long as over 80% of the oil imported into Finland comes from the Primorsk and Ust-Luga oil ports in Russia, the calculated round trips and Finland's cargo capacity are sufficient.

In addition to being insufficient for import purposes, the Finnish tonnage proved lacking in its domestic distribution transport capacity on the Finnish coast. Finland does not have enough small tonnage for distributing chemical and oil products to different ports. In disruption situations, this may increase the need for transporting fuel on roads and railways where the transport capacity is limited.

Without examining different traffic areas in detail, it can be said that managing all sea transport imports with vessels registered in Finland would have required the entire merchant fleet to have carried out slightly less than 70 round trips in 2012. This would have meant a little less than two round trips every week. In the case of exports, the same theoretical calculation results in 86 round trips. When technical and geographical aspects are taken into consideration, achieving this level is not possible even in the Baltic Sea region. Finland's seaborne trade is dependent on foreign tonnage. Approximately one in three vessels arriving in Finland sailed under the Finnish flag. In departing vessels, this figure was only one in four.

5. Determining a goal state for sufficient sea transport

Like the government decisions on security of supply and the government budget proposals (GVBP 2008, 2009-2015), the Maritime Transport Strategy for Finland 2014–2022 published by the Ministry of Transport and Communications (Liikenne ja viestintäministeriö 2014, p. 16) also describes the desired state of Finland's maritime or shipping policy with regard to a sufficient fleet, although an exact number of vessels or the composition or structure of the fleet has not been determined. The Maritime Transport Strategy emphasises managing security of supply both during disruptions in normal conditions and during exceptional circumstances: *“The most severe external threat to security of supply is considered to be a crisis situation where the nation's ability to produce or acquire critical products or services from abroad has been temporarily weakened (GVD 857/2013). Maintaining security of supply requires special procedures [these special procedures have nevertheless not been listed] to ensure that Finland has a sufficient ice-class tonnage sailing under the Finnish flag that is able to secure the critical transport needs of society and industry in all circumstances. Finland also needs to ensure that the entire shipping logistics system and the related critical infrastructure are prepared for severe disruptions that may occur in normal conditions.”*

Supply of sea transport is measured in terms of the supply of tonnage, which refers to the available capacity for carrying goods critical to security of supply from one or more ports to one or more ports by sea.

6. The Baltic Sea traffic and transport environment

In 2012, the total amount of cargo handled in the ports bordering the Baltic Sea was 839.4 million tonnes. According to the Baltic Port List 2013 publication by the Centre for Maritime Studies (Baltic Port List 2013), this amount does not include the 648,000 tonnes of transit goods handled in Ust-Luga and Kaliningrad which increase the total amount of sea transport to 840 million tonnes. Around 42% of the cargo was liquid bulk, 32% other dry cargo and 26% dry bulk. Measured by total cargo volume, Russia is the leading country in the Baltic Sea region: it has a growing market share of a quarter (25%) and is followed by Sweden with a fifth (21%). Approximately 13% of the cargo went through Finnish ports and the rest (42%) through Latvian, Polish, Danish, German, Estonian and Lithuanian ports. In 2010, the largest Baltic Sea ports by cargo volumes were Primorsk, St. Petersburg, Gothenburg, Klaipeda and Riga (Serry 2014).

In 2014, the maritime transport of the eight states on the coast of the Baltic Sea (excluding Russia) consisted of 726.8 million tonnes of exports and 1.0 billion tonnes of imports (Baltic Course 2014; Baltic Transport Journal, Baltic Port Yearbook 2014–2015, p. 14; Eurostat 2015). Of the Baltic Sea region shipping, Russia accounted for 170 million tonnes of exports and 14.4 million tonnes of imports. The share of liquid bulks was 340 million tonnes, and the main operators were Russia (133 million tonnes), Sweden (61 million tonnes) and Finland (29.5 million tonnes).

In 2014, a total of 105 million tonnes of crude oil was both imported and exported across the Baltic Sea, amounting to a total of 210 million tonnes of oil transport. According to EIA Oil Transit Chokepoints 2013 data, 3.3 million barrels of oil are transported through the Danish straits per day. This is more than the amount of oil that travels through the Suez Canal (3.2 million barrels), the Bosphorus (2.3 million barrels) and the Panama Canal (0.85 million barrels). A total of 17 million barrels is transported through the Strait of Hormuz every day (US EIA 2015). The amount of oil transported through the Danish straits is smaller than the exchange of goods in the region's oil ports that includes both export and import values (Baltic Transport Journal 2015b). According to a theoretical calculation, transporting this amount of oil across the Baltic Sea would require approximately 20 Aframax oil tankers (80,000-120,000 dwt). This would mean three loaded tankers leaving port every day and having nine tankers at sea at all times. The calculation covers the distance from Primorsk all the way to the Danish straits. In reality, the tankers travelling the Baltic Sea are smaller Panamax tankers (60,000-80,000 dwt), which means that there are also more of them.

Around 105 million tonnes of oil products are annually transported across the Baltic Sea. Performing this 'distribution transport' requires around 200 product tankers with a deadweight tonnage of 10,000-20,000 tonnes. Shipping cannot always accurately be described using theoretical models, but based on actual examples it is possible to determine that the ports on the coasts of the Baltic Sea are annually visited by around 2,000 different types of tankers (BTJ 5/2015).

Some 220 million tonnes of dry bulk are transported across the Baltic Sea every year. Coal transport amounts to over 70 million tonnes, crude ore transport to 50 million tonnes and the transport of chemicals and fertilisers to around 40 million tonnes every year. The main operators are Russia (43 million tonnes), Finland (36 million tonnes) and Latvia (31 million tonnes).

The transport of general cargo amounts to slightly less than 300 million tonnes in the Baltic Sea region, and the main operators are Sweden (77 million tonnes), Russia (47 million tonnes) and Finland (39 million tonnes).

At any time of day, there are some 2,000 merchant vessels ploughing the Baltic Sea. On Monday 25 May

2015 at 21.00, the Finnish maritime situational awareness system (Automatic Identification Systems for Ships AIS, International Convention for the Safety of Life at Sea, IMO 2001) identified 2,935 vessels that included 162 tankers, 406 other cargo ships and 236 fishing vessels. The Finnish reporting system covered 441 Finnish vessels that consisted of 5 tankers and 51 other cargo ships. The number of Swedish vessels was 1,202, of which 19 were tankers and 25 other cargo ships.

7. Finland's maritime traffic and transport performance

The market economy is a self-controlling system where balancing supply and demand can be used as a tool. The demand leverage is formed by the volume of goods transported in normal conditions and the supply by the vessels registered in Finland and marked in the Finnish merchant vessel list (Stopford 2009).

In 2014, the foreign seaborne trade carried out in Finland amounted to 96 million tonnes, including transit-transport. Both exports and imports amounted to approximately 48 million tonnes. Finland's foreign seaborne trade transport amounted to total 88 million tonnes, (85% of the total foreign trade). The transport of transit goods saw a slight increase and amounted to 8 million tonnes (Finnish Transport Agency, FTA 5/2015).

According to Finnish Customs statistics for the year 2014 (that do not include the transport of transit goods), 31.8 million tonnes (66%) of the total Finnish 44.5-million-tonne sea imports came from the Baltic Sea region (Russia's share included). A total of 28.5 million tonnes were imported from the EU region and 44.8 million tonnes from all European countries. After Russia (14 million tonnes), the main import countries were Sweden (6.9 million tonnes), Norway (2.9 million tonnes), the Netherlands (2.6 million tonnes) and Germany (2.6 million tonnes). The majority of the Finnish imported energy also came from the Baltic Sea region. Approximately 9.3 million tonnes (83%) of the 11.2 million tonnes of crude oil annually imported to Finland came from Russia. The total amount of imported mineral oil and mineral oil products was 3.8 million tonnes, of which 1.0 million tonnes came from Russia and 1.2 million tonnes from Sweden.

Finnish imports from Russia amounted to approximately 14.2 million tonnes, which included 8.6 million tonnes of crude oil and 3.8 million tonnes of coal. Chemical imports amounted to 4.35 million tonnes, which included 400,000 tonnes of fertilisers. Of this amount, slightly less than 300,000 tonnes were imported from Russia. Exports to Russia amounted to less than 0.2 million tonnes.

A total of 36.4 million tonnes of the imported goods came from the 10 major import countries. This is more than 80% of all imported goods (Figure 1).

According to the Finnish Customs statistics for the year 2014 (that do not include the transport of transit goods), Finnish seaborne exports amounted to 40.6 million tonnes. EU exports amounted to 23.6 million tonnes (58%) and exports to all European countries to 24.4 million tonnes. The main export countries were Sweden (4.7 million tonnes), Germany (4.4 million tonnes), China (3.8 million tonnes) and Great Britain (3.5 million tonnes).

In foreign seaborne trade, the share of transport carried out by Finnish tonnage decreased from the previous year's 34% to 33%. In imports, the share of transport carried out by Finnish vessels dropped to 43.5%, but in exports it rose to 22.5%.

Figure 1. Finland's total seaborne trade figures, import and export, in 2014 (million tonnes)



Note: Lithuania arrow is not included in this picture: According to the Finnish Custom Statistics, the imports from Lithuania was 2014 approximately 0.6% of the Finnish total imports and approximately 0.7% of the Finnish total exports (Finnish Custom Statistics, The Finnish trade 2005.2015).

Source: Baltic Transport Journal, Baltic Port Yearbook 2014/2015, p. 39.

According to the statistics from 2014, vessels importing goods covered a total of 31,403 million tonne-nautical miles, of which Finnish vessels accounted for 35.9% or 10,017 million tonne-nautical miles. In exports, vessels covered a total of 75,187 million tonne-nautical miles, of which Finnish vessels accounted for 17.5% or 13,158 million tonne-nautical miles.

Based on Finnish Transport Agency data on the transport of different commodity groups from the year 2013 (measured in tonne-nautical miles), Finnish vessels accounted for 7% of oil product imports, 23% of cereal imports, 40.1% of coal and coke imports, 11.6% of fertiliser imports, 6.2% of chemical industry imports, 8.4% of raw mineral and cement imports, 34.1% of general cargo imports and 8.8% of the imports of other merchandise.

The role of Finnish vessels in transporting imported goods in 2013 has been presented in more detail in Appendix 1 (on page 67). Finnish vessels accounted for 9 billion tonne-nautical miles (23.8%) of the total volume of 37.7 billion tonne-nautical miles.

The role of Finnish vessels was the smallest in the transport of oil and chemical products, where the port of shipment is only a couple of hours away. If new oil ports are taken into use in the future and they are further away, the Finnish tonnage will not be able to maintain its current share of the transport volume. The same applies to the transport of chemical industry products.

The fact that more than 50% of the oil imported into Finland is further refined and then exported to third countries must naturally be taken into account when transport volumes are assessed. This also applies to fertilisers: Yara is Finland's only manufacturer of fertilisers, and 60% of the raw materials that are imported into Finland are later exported as fertiliser products.

BSR Policy Briefing 1/2016

In 2014, an average of 160 vessels arrived at or departed from Finnish ports every day, and only one in three of these vessels was registered in Finland. When the average weight of the cargo transported by the vessels is 2,000 tonnes, the total weight of the transported goods amounts to 320,000 tonnes. The cargo transported by 160 vessels in one day is equivalent to 7,000 railway wagons or 11,200 full-trailer trucks full of cargo (FTA 5/2015).

At the end of the year 2014, there were 108 vessels registered in Finland including 1 passenger ship, 15 ro-ro passenger ships (Ropax), 32 ro-ro ships, 4 dry bulk ships, 26 other dry cargo ships, 3 container ships, 8 tankers and 19 special-purpose vessels (mainly tugboats). According to the Finnish Merchant Fleet Statistics 2014 published by Trafi, the capacity or deadweight tonnage of the merchant fleet was 776,353 tonnes.

The transport performance analysis of the vessels in the 2014 merchant fleet list is based on their total deadweight tonnage. The differing properties of container ships, ro-ro ships and Ropax ships carrying general cargo have been taken into account in the comparison of the vessels' deadweight cargo capacity. The limiting factor is sometimes the availability of space for containers or vehicles and sometimes the deadweight tonnage. The details concerning the cargo capacity of the merchant fleet provide essential raw data for my ongoing research project. In this article, I will only provide some of the conclusions I have reached.

When the sufficiency of the Finnish merchant fleet is analysed in the light of the 47.6 million tonnes of goods that are annually imported by sea, the following facts can be determined:

1) Importing 17.7 million tonnes of crude oil, oil products and liquid chemicals using our 342,055 dwt tanker fleet requires 51 round trips per year and is possible if the goods are imported from the Baltic Sea region. The fact that Neste further refines and sells approximately 50% of the imported crude oil should be taken into account.

2) Importing 5.6 million tonnes of coal and coke using our 104,500 dwt coal fleet requires 53 round trips per year when the goods are imported from the Baltic Sea region. This means one round trip per week. The voyage from Helsinki to the southern parts of the Baltic Sea takes approximately 36 hours. When loading and unloading are taken into account, approximately one week needs to be reserved for a round trip. Our coal fleet is capable of importing the necessary amount of coal from the Baltic Sea region. Finland also has four 14,000-tonne barges in reserve. In total, they can carry 56,000 tonnes of cargo.

3) The annual import of general cargo amounts to 24.5 million tonnes. Based on the deadweight tonnage and deadweight cargo capacity of Finland's ro-ro, Ropax, container, dry bulk and other dry cargo ships, the total deadweight cargo capacity for general cargo is approximately 450,000 tonnes.

Performing the entire import of general cargo using the available vessels, with a combined cargo capacity of 450,000 tonnes, would require around 56 round trips per year. This would mean approximately one round trip per week. This is not possible for several reasons. Firstly, the trip from Kvarken to Trelleborg is approximately 780 nautical miles, which means that a one-way trip lasts around two days at a speed of 15 knots. The second constraint is that both the ro-ro and Ropax ships are used for scheduled transport. The regular route of Langh Shipping, for instance, begins at the ports of the Gulf of Bothnia, continues to St. Petersburg and the English Channel and returns to the Gulf of Bothnia. Travelling the entire route takes 12–14 days (Langh Ship 2016).

If the Finnlines ships, which are in foreign ownership, were not available for one reason or another (almost 50% of the transport capacity would be missing), the number of round trips needed per year

would grow to around 70, which would mean one and a half round trips per week.

In the case of exports, a similar theoretical calculation reveals that the exports of 36 million tonnes would require 82 round trips. Without the ships of Finnlines, the number of round trips would be over 100.

The transport of oil, oil products, liquid bulk and dry bulk are mainly in foreign hands, and this is also often the case when it comes to controlling the traffic to and from Finland and making the decisions concerning this traffic. In the case of container traffic, ships often follow a regular circular route that includes several ports in different countries. Container ships carry both import and export goods, and the goods are owned by several operators. Finland is just one destination among a group of countries on the coasts of the Baltic and the North Sea. For instance, the container route of Containerships follows the route Helsinki – St. Petersburg – Riga – Klaipeda – Lübeck – Rotterdam – Tilbury, and ships travel along the route in two-week periods. The return route contains the same ports or at least some of them. There are two to three vessels on the route, which means that a ship visits Finland at least once a week (Österlund 2014).

In bulk cargo ports, ships deliver cargo based on warehouse capacity, consumption and the rhythm required by refineries. In the port of Naantali in Southwest Finland, for instance, a coal ship carrying 16,000 tonnes of coal arrives approximately once a week to replenish the coal warehouse of the local coal plant that is large enough to house enough coal for the needs of one year. In the energy sector, the bulk cargo market is generally more susceptible to fluctuations in the electricity market than other forms of cargo. The consumption of energy coal is directly proportional to the price of electricity.

In addition to providing transport, dry-bulk carrying vessels also act as containers for the cargo. Loading and unloading are usually performed using bucket elevators or conveyors that transport the cargo directly to a warehouse, and vessels can also be used for short-term storage at ports.

In the case of increasingly popular container transport and transport on wheels, Finland is mainly dependent on scheduled transport systems that are in foreign ownership. This means that the transport decisions are also made abroad. Finland is just one user among a group of equal users transporting cargo in the same vessel.

In the case of vessels carrying liquid and dry bulk, we are usually the only consignee or consigner. When general cargo is transported, the transport arrangement may sometimes be similar to the one used in container transport: the cargo is unloaded or loaded at one Finnish port.

When bulk cargo is freighted, the seller primarily agrees on the freight and usually selects a known, foreign carrier. The Finnish-owned ESL Shipping coal fleet has enough capacity to manage the entire Finnish coal import from the Baltic Sea region (Koskinen 2015). Only 7% of chemicals are transported using vessels registered in Finland.

8. Conclusions

Baltic Transport Outlook 2030 predicts that shipping in the Baltic Sea will increase from the 750-million-tonne level achieved in 2010 to slightly less than 1,000 million tonnes by 2030. This would mean that shipping would increase by approximately 30%. The same publication predicts that Finnish shipping will reach some 120 million tonnes by 2030 and increase by slightly less than 30% compared to the level of 2010 (Baltic Transport Outlook 2030).

BSR Policy Briefing 1/2016

If the sea transport logistics chain is disturbed for one reason or another, a vessel delivering cargo may not be able to stop at all the ports belonging to its normal route. In order to be able to react to these kinds of situations rapidly, Finland needs planned and prepared solutions that enable vessels to unload their entire cargo at one Finnish port. The traffic authorities need to be in charge of managing the entire transport system covering all forms of transport.

At least for the most important Finnish ports, an estimate of how much their cargo handling volumes can be increased is needed. This estimate can then be used as a tool for managing sea traffic. The ability to centralise traffic and direct it to ports located either on the Gulf of Finland or the Gulf of Bothnia must be discussed and planned in advance. The onward transport of cargo must also be addressed. During the ice winter 2010-2011, the ice situation at Finnish ports encouraged Finland to adopt a management system led by the authorities. It is important that the authorities also plan how the flow of goods from ports to consumers will be organised in the changed conditions and that intermodal freight transport equipment and onward transportation are also specified. Ports have limited storage facilities for arriving goods.

The traffic authorities should provide planning principles and guidelines for the maintenance and preparation activities related to the continuity management of ports. This would ensure a centralised approach and co-ordinate activities.

Ports maintain the infrastructure required by sea traffic following a 'service hotel' principle, and sea traffic operators utilise the logistics system according to their needs. These needs are based on financial principles or other principles related to centralised management. Connecting sea and land transport in a seamless manner requires comprehensive co-operation in traffic management and collaboration between different authorities.

Carrying out Finnish seaborne trade with a sufficient Finnish tonnage can be implemented either by acquiring the necessary tonnage or at least control of the tonnage or by creating a national freight organisation that is constantly aware of the market situation so that the necessary tonnage can be chartered at short notice. This expert organisation should always be one step ahead of the situation.

In order to be able to assess the sufficiency of the Finnish tonnage, all parties should have access to the same information concerning the dead weight tonnage (dwt) or dead weight cargo capacity (dwcc) of Finland's merchant fleet. This would require amending the Finnish Register of Ships Act (512/1993) so that providing the dwt value of registered vessels would be mandatory. Currently, different measures are used to assess Finland's cargo capacity. This has led to a situation where the unitless gross tonnage (GT) and net tonnage (NT) are sometimes incorrectly used to describe Finnish cargo capacity. Since the risk threshold year of 2008, the capacity or deadweight tonnage of our merchant fleet has been decreasing, as has the share of foreign trade transport carried out by Finnish vessels. Only the gross tonnage and net tonnage have increased. If statistics are misinterpreted, it may seem that the Finnish sea transport capacity has grown, but this is not the case.

Finland will not survive alone in difficult conditions, which is why the necessary measures for improving the situation must be taken before problems arise.

“The future will be here faster than we expect, and the world changes when it is changed.”

Bo Österlund, Commodore, one-star admiral (retired) in Turku
on Finnish Independence Day 6 December 2015.

References

- Baltic Course Magazine. (2015). Cargo Handling in the Baltic Eastern Coast Seaports 2014. CORDEX MEDIA SIA, Riga, Latvia.
- Baltic Port List (2013). Market review of cargo development in the Baltic Sea Ports. Centre for Maritime Studies, University of Turku, Turku 2013.
- Baltic Transport Journal. (2015). Baltic Port Yearbook 2014–2015: Shift of gravity. Baltic Press SP. ZO. O, Gdynia, Poland.
- Baltic Transport Journal. (2015). The Baltic bulk market. The Baltic dry & oil Landscape. 5/2015. Baltic Press SP. ZO. O, Gdynia, Poland.
- Baltic Transport Outlook 2030. Executive Report - final version. Report no: BTO_R7TP_009, Version A.1, December 15th, 2001.
- Coyle, J.J., Bardi, E., Novack, R.A., (2000). Transportation South-Western, Cincinnati.
- Etelämäki, M. Huoltopataljoonia ja -rykmenttejä vaiko ihan jotain muuta? ... 257, Tiede ja Ase No 63/2005.
- Eurostat (2015). Compilers guide on European statistics on international trade in goods. Manuals and guidelines, 2015 edition.
- Finland's National Emergency Supply Agency 2016. Security of supply ensures a functioning society under all circumstances.
- Finnish Customs (2014). Transports of foreign trade by countries, January-December 2014. Transport Statistics is not part of the Official Statistics of Finland. http://www.tulli.fi/fi/suomen_tulli/.
- Finnish Maritime Administration (2000, 2005). Official Statistics of Finland. <http://www.trafi.fi/en/maritime>.
- Finnish Merchant Fleet Statistics (2010). Official Statistics of Finland 15/2011.
- Finnish Merchant Fleet Statistics (2012). Official Statistics of Finland 13/2013.
- Finnish Merchant Fleet Statistics (2014). Official Statistics of Finland December 2015.
- Finnish Transport Agency; Statistics on International Shipping 2010, 2012, 2014. <http://www.trafi.fi/en/maritime>.
- Hallituksen esitys, (2008). (Government Proposal, GVP 148/2008) Eduskunnalle laeiksi meriliikenteessä käytettävien alusten kilpailukyvyn parantamisesta annetun lain, merimieseläkelain 4 §: n ja erityyöaikalain muuttamisesta 3.10.2008: HE 148/2008, FINLEX.
- International Maritime Organisation, IMO, Guidelines for the onboard operational use of shipborne Automatic Identification Systems (AIS). Resolution A.917 (22), Adopted on 29 November 2001, Agenda item 9.
- Kananen, I. (2011). Huoltovarmuuden toimintaympäristön muutoksia vuosina 1988–2011, pp. 3–17, Sotataloustietoutta X, Sotataloudellinen Seura: Saarijärven Offset Oy, Saarijärvi 2011.
- Koskinen, M. (2015). Haastattelu: Kuivien irtolastien kuljettaminen Itämerellä. ESL Shipping, Helsinki 21.8.2015.
- Langh Ship (2016). Fleet position 8.11.2015. <http://www.langhship.fi/en/>
- Liikenne- ja viestintäministeriö 2014, Meriliikennestrategia 2014-2022, LVM:n julkaisusarja 9/2014.
- Liikennevirasto. Ulkomaan meriliikennetilasto 2014, Liikenneviraston julkaisu 5/2015.
- Liikennevirasto. Merenkulun tuet. Kauppalaivaston dwt, 2000, 2005, 2008, 2010. Received from merenkuluntuet@liikennevirasto.fi December 2015.
- Lun, Y.H.V., Lai, K-H., Cheng T.C.E., (2010) Shipping and Logistics Management. The Hong Kong Polytechnic University, Department of Logistics and Maritime Studies. Springer 2010. Retrieved from https://books.google.fi/books?id=Sp_9ZJPoQ9MC&pg=PA17&lpq=PA17&dq.
- merenkuluntuet@liikennevirasto.fi 2000, 2005, 2008, 2010, 2012, 2014. Kauppa-aluslaivaston kokoonpano, kantavuus ja brutto sekä netto.
- National Board of Navigation (1980). Shipping between Finland and Foreign Countries. Official Statistics of Finland I B:63b.
- National Board of Navigation (2009).
- NESA, National Emergency Supply Agency. Security of Supply ensures a functioning society under all circumstances. Retrieved from <http://www.nesa.fi/>.
- Pesonen, A. (1985). Helsinki sodassa. Kirjayhtymä, Vaasa 1985 ISBN 951-26-2783-3.
- Saastamoinen, J. (2008). Brezhnevin katoksessa ja muita juttuja Nesteestä. Neste Oil Historiikki 2008, toinen painos, WSOY,
- Serry, A. (2014). "Dynamics of maritime transport in the Baltic Sea: regionalisation and multimodal integration" in 6th International Conference on Maritime Transport. Retrieved from <https://mtconference.upc.edu/home> 5.12.2015.
- Shipping and Logistics Management, p 17, retrieved from <https://books.google.fi/books?isbn=1848829973>.
- Statistics from the Finnish Maritime Administration (2006). Statistics on Shipping between Finland and Foreign Countries. 3/2006.

BSR Policy Briefing 1/2016

- Statistics from the Finnish Maritime Administration (2008). Statistics on Shipping between Finland and Foreign Countries. 5/2009.
- Statistics from the Finnish Maritime Administration (2008). Finnish Merchant Fleet Statistics 4/2009.
- Statistics from the Finnish Transport Agency (2010). Statistics on Shipping between Finland and Foreign Countries. 2/2011.
- Statistics from the Finnish Transport Agency (2012). Statistics on Shipping between Finland and Foreign Countries. 7/2013.
- Statistics from the Finnish Transport Agency (2014). Statistics on Shipping between Finland and Foreign Countries. 5/2015.
- Stopford, M. (2009) Maritime Economics. 3rd edition, 2009. Routledge, Taylor and Francis Group, London and New York.
- Stopford, M. (2013). The Five Major Changes in Shipping Today. Copenhagen BLUE Business Shipping Conference 2013, Hotel Marriott, Copenhagen 24th January 2013.
- Suomen ja Liettuan välinen kauppa 2005-2015, Suomen tullit 2015, Retrieved on 17.1.2016 from http://www.tulli.fi/fi/tiedotteet/ulkomaankauppatilastot/katsaukset/maat/liettua15/liitteet/2015_M24.pdf.
- Suomen Kauppalaivasto 1939, Merenkulkuhallituksen Tilasto- ja rekisteritoimiston julkaisu, Valtioneuvoston kirjapaino 1939.
- Suomen Kuvalehti. (1950). Tunnetteko Suomea, Ulkomaan Kauppa ja Sotakorvaus. Suomen Kuvalehden ja Kotilieden Suomi-kirja. N: o 44 A, pp. 46-47.
- Suomen turvallisuus- ja puolustuspolitiikka (2009). Valtioneuvoston selonteko. Valtioneuvoston kanslian julkaisusarja 11/2009.
- Suomen Varustamot ry, jäsenluettelot 2008, 2012, 2014. Retrieved from <http://suomenvarustamot.fi>
- The Finnish Customs (2014). Transports of foreign trade by countries. January-December 2014 Ship transports. Retrieved on 4 March 2015 (<http://www.tulli.fi>).
- Trafikanalys 2015, Sjötrafik 2014, Statistik 2015:12, publicerad 25.5.2015.
- Transportstyrelsen (2015). Sjöfart, fartygsregister. Retrieved from <https://www.transportstyrelsen.se/sv/sjofart/>
- Ulkomaan meriliikennetilasto (2014). Statistics on International Shipping 5/2015. http://www2.liikennevirasto.fi/julkaisut/pdf8/liti_2015-05_ulkomaan_meriliikennetilasto_web.pdf.
- UNCTAD, United Nations Conference on Trade And Development. Review of Maritime Transport 2015. UNCTAD/RMT/2015 UNITED NATIONS PUBLICATION. Retrieved from http://unctad.org/en/PublicationsLibrary/rmt2015_en.pdf.
- US Energy Administration Agency (2015). Annual Energy Outlook. <http://www.eia.gov/forecasts/aeo/>.
- Valtioneuvoston päätös (1995). (GVD, 1440/1995). Päätös huoltovarmuuden tavoitteista. <http://www.finlex.fi/fi/laki/alkup/1995/19951440>.
- Valtioneuvoston päätös (2008). GVD, 539/2008). Päätös huoltovarmuuden tavoitteista. <http://www.finlex.fi/fi/esitykset/he/2012/20120033>.
- Valtioneuvoston päätös (2013). (GVD, 857/2013). Päätös huoltovarmuuden tavoitteista. <http://www.finlex.fi/fi/laki/alkup/2013/20130857>.
- Yliskylä-Peuralahti, J., Spies, M., Kämärä, A., Tapaninen, U. (2011) Finnish Critical Industries, Maritime Transport Vulnerabilities and Societal Implications. Publications from the Centre for Maritime Studies, A 55-2011. University of Turku.
- Österlund, B. (2014). Meriliikenteen huoltovarmuusselvitys 2014. Huoltovarmuuskeskus 1.4.2014. Helsinki. In the author's possession.

Appendix 1.

Share of transport carried out by Finnish vessels in 2013

- Finnish vessels carried out 7.4% of all oil product imports. This is 412.6 million tonne-nautical miles of the total 5.6 billion tonne-nautical miles. Between Primorsk and Kilpilahti (distance approximately 100 nautical miles), carrying 100,000 dwt of cargo using the Finnish tonnage would require over 40 round trips. This would mean approximately one trip per week, and the Finnish tonnage is capable of this.
- Finnish vessels carried out 40.1% of all coal and coke imports. This was 2.9 billion tonne-nautical miles of the total 7.1 billion tonne-nautical miles.
- Finnish vessels carried out 11.6% of all fertiliser imports. This was 7,042 tonne-nautical miles of the total 60,525 tonne-nautical miles.
- Finnish vessels carried out 6.2% of all chemical industry imports. This was 179.4 million tonne-nautical miles of the total 2.9 billion tonne-nautical miles.
- Finnish vessels carried out 8.4% of all raw mineral and cement imports. This was 457 million tonne-nautical miles of the total 5.5 billion tonne-nautical miles.
- Finnish vessels carried out 23% of all cereal imports. This was 9.8 million tonne-nautical miles of the total 42.7 million tonne-nautical miles.
- Finnish vessels carried out 34.1% of all general cargo imports. This was 1.4 billion tonne-nautical miles of the total 4.0 billion tonne nautical miles.
- Finnish vessels carried 8.8 % of other merchandise imported to Finland. This was 282.0 million tonne-nautical miles of the total 37.6 billion tonne-nautical miles.

Sources: Finnish Transport Agency 5/2015, Statistics on International Shipping 2014.

Appendix 2.

In this document, foreign sea transport is examined by commodity group based on FTA statistics from the year 2014 and the usability of the available tonnage. The commodity groups being examined form the “Big Trio” and include liquid bulk (LB), dry bulk (DB) and general cargo (GC).

Goods imported to Finland:

Liquid bulk:

- 17.7 million tonnes of crude oil, oil products and chemicals

Dry bulk:

- 5.6 million tonnes of coal and coke

General cargo, ro-ro, Ropax, containers, break bulk:

- 11.9 million tonnes of fertilisers, ores and concentrates, raw minerals, timber and cereals
- 9.2 million tonnes of general cargo and metals
- 3.4 million tonnes of other imported merchandise

in total 47.96 million tonnes (including transit goods).

Goods exported from Finland:

Liquid bulk:

- 11.2 million tonnes of oil products and minerals

General cargo, ro-ro, Ropax, containers, break bulk:

- 3.7 million tonnes of sawn wood
- 11.9 million tonnes of other forest industry products
- 9.0 million tonnes of general cargo and metals
- 12.2 million tonnes of other merchandise

in total 48.2 million tonnes (including transit goods).

Shipping and environmental governance in the Baltic Sea region

Daria Gritsenko

Executive summary

The Baltic Sea is very shipping-intense: about 15% of world seaborne trade takes place in the Baltic Sea region (BSR). Whereas maritime trade is a significant source of economic prosperity in the region, the intensification of maritime activities creates significant pressure on fragile Baltic ecosystem. Shipping is a source of discharges to water, air, and shores, posing threats to ecosystem health through introduction of contaminants and habitat destruction. CO₂ emissions from shipping contribute to the global climate change. In order to address adverse social and environmental effects of shipping, a system of global and universally applicable rules has been established by the International Maritime Organization (IMO). The global system is complemented by a set of regional arrangements that account for local specificity of particular maritime regions. In the BSR, the Helsinki Commission plays an essential role in crafting mechanisms for regional adaptation of global marine protection regime established by the IMO. Private and public non-binding initiatives have contributed to the emergence of voluntary self-regulation and promulgation of corporate social responsibility norms within Baltic maritime community. Whereas significant progress has been made in the BSR to mitigate the adverse environmental effects of shipping, there are several issues that require renewed policy attention, among them additional research on sustainable shipping scenarios, ongoing regional monitoring at the shipping-environment interface, targeted instruments to address different segment of shipping, and seizing the opportunities of digitalisation in shipping for the benefit of Baltic Sea environmental protection.

1. Introduction

The Baltic Sea has some of the busiest shipping routes in the world with an average of 2000 vessels at sea at any time. Both the number of ships and the quantity of cargo were growing in the past two decades. Out of 21,434 vessels which automatic identification system (AIS, an automatic tracking system for identifying and locating ships) signal has been recorded in the Baltic Sea during 2014, 8570 had an IMO registry number indicating commercial marine traffic (Figure 1). The significant amount of intra-regional maritime trade and transshipment makes the Baltic Sea region a well-developed transport market, with 15% of global seaborne trade estimated to takes place in the Baltic Sea (HELCOM 2009). Short-sea shipping, coastal and cruise tourism, offshore wind, shipbuilding, aquaculture and blue biotechnologies are among the most promising sectors of the growing Baltic maritime economy (EUNETMAR 2013). Growth in the maritime sector presents good employment opportunities and economic development. At the same time, the intensification of maritime activities create significant pressure on fragile Baltic ecosystem.

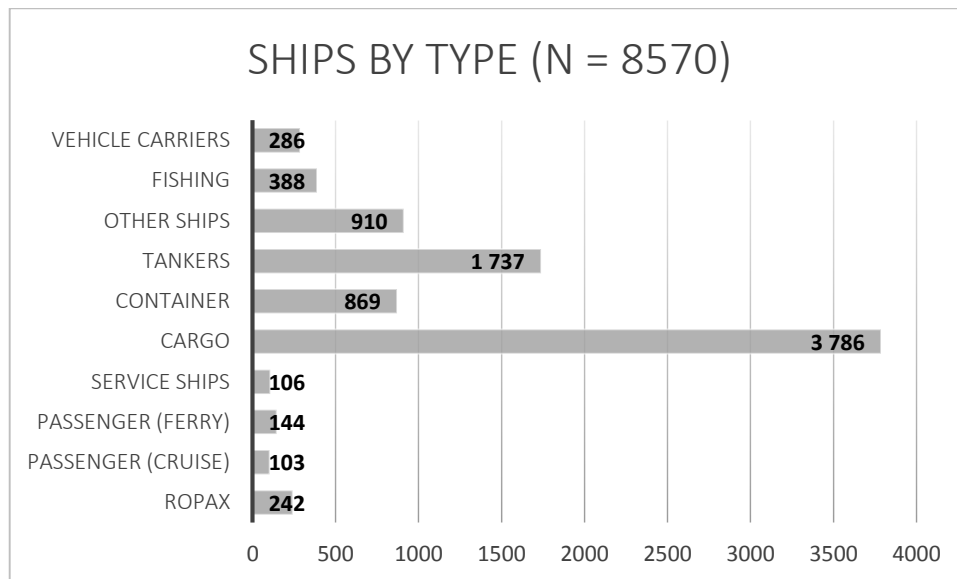
Figure 1. Commercial shipping in the Baltic Sea, by vessel type (2014)

Source: based on AIS signals, only ships with IMO number, Johansson and Jalkanen (2015).

There are different kinds of pollution harmful for a maritime region. Among the major sources of Baltic Sea pollution are land-based, vessel-based, pollution from dumping, through and from the atmosphere and through exploration of the seabed (extractive activities). Though it has been estimated that the major pollution load come to the Baltic Sea from the land-based sources (HELCOM 2015a), shipping operations significantly affects the Baltic Sea environment in a multitude of ways. Seagoing vessels are responsible for a wide range of discharges to water, atmosphere and shores, including oil, hazardous substances, garbage, sewage, air pollutants, (micro)plastic, introduction of alien species, and noise. As a result, a number of marine species in the Baltic Sea are under threat from shipping activities, affected by contaminants and habitat destruction.

The countries of the Baltic Sea basin were forerunners in their efforts to address ecological status of the sea in a comprehensive and transboundary manner as they agreed to establish the Convention on the Protection of the Marine Environment of the Baltic Sea Area (Helsinki Convention) in 1974. Since 2000, when the updated Helsinki Convention entered into force, significant improvements in areas covered by the Convention have been made. The governing body of the Helsinki Convention, the Baltic Marine Environment Protection Commission (Helsinki Commission, or HELCOM), is considered to be at the centre of Baltic environmental co-operation (Lääne 2001). Though HELCOM is an intergovernmental body that does not have law-making power, its recommendations are influential. HELCOM's thematic working groups collect and integrate data from around the Baltic Sea, providing expertise in regional environmental affairs, creating platform for meetings and communication, and enabling co-operation beyond the EU scope, which is important for maintaining relations with stakeholders from Russia. HELCOM's Baltic Sea Action Plan (BSAP) has become a guidebook for environmental co-operation in the BSR. Following its mandate, the HELCOM aims to protect the Baltic Sea from the negative environmental impacts of shipping by encouraging co-operation between actors at different levels (local, national, regional, supranational) and establishing a framework for regionally specified regime. To advance this mission, HELCOM has created a unique pool of integrated, comparable information on shipping accidents, vessel-induced pollution, illegal discharges and similar matters, to which open access is enabled.

2. Emissions and discharges from Baltic shipping

Maritime transport is a source of a wide range of polluting emissions and discharges produced in the process of shipping operations, which includes cargo loading/unloading, docking, manoeuvring, piloting, bunkering, and navigation. Negative environmental effects from shipping operations can be divided into five groups:

- 1) discharges into water (e.g., waste from machinery and auxiliary systems operation including engine room waste and slops, bilge waters, bunker and cargo oil spills, sewage, garbage, liquid and solid waste produced on board, lost cargo);
- 2) emissions into air (e.g., sulphur dioxide (SO_x), nitrogen oxides (NO_x), particulate matters (PM), ozone-depleting substances (ODS), volatile organic compound (VOC), greenhouse gas (GHG));
- 3) discharges onto shores (garbage and ship waste, sewage, oil-contaminated waste);
- 4) introduction of alien species; and
- 5) noise and vibration.

In respect to their origins, oil spills and cargo losses tend to be more often associated with accidental pollution, whereas air emissions, garbage, sewage, waste and bilge waters, alien species, noise and vibration more typically stem from routine shipping operations (Hassler 2011).

2.1. Oil pollution

Being the main source of energy, oil is transported in increasing quantities and to a large extent by sea. In the year 2012, over 342 million tonnes of crude oil and oil products were transported via the Baltic Sea, of which roughly a half via the Gulf of Finland (Brunila et al. 2014). The increase in oil transportation is related to the intensification of maritime trade in the Baltic Sea in general, as well as to the emergence of the Baltic as a major energy transport route (Figure 2). The motivations for increased use of sea routes for the transportation of oil from Russia to the main European consumers were the geopolitical shifts in the region and the willingness of the Russian Government to avoid energy transit via third countries, thereby maintaining large control over the supply chain.

Figure 2. Trends in Baltic maritime international traffic, 2006-2012 (tonnes)

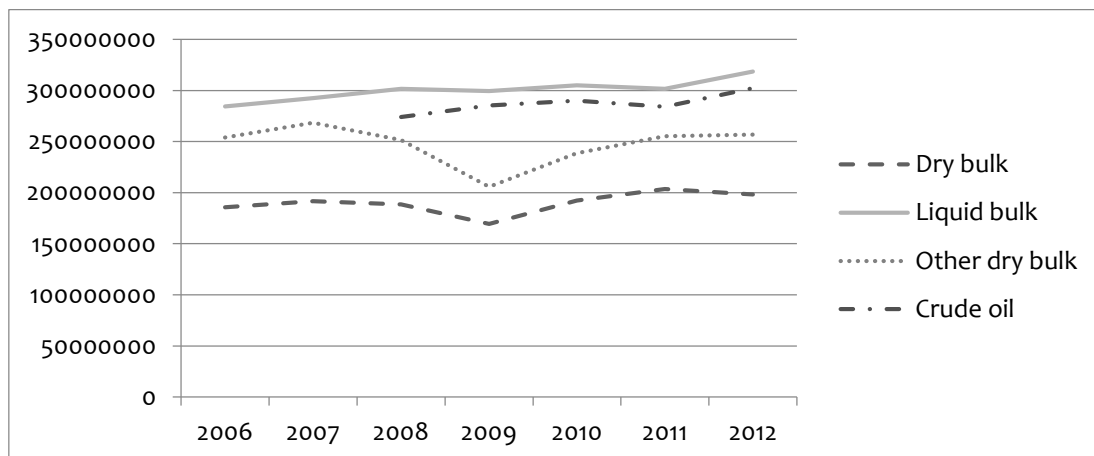

Note: reported volumes are based on port data. Crude oil data available only for 2008 - 2012.
Source: University of Turku, Center for Maritime Studies (as of March 2014, unpublished).

The fact that oil spills constitute a significant environmental risk has been recognised earlier than other environmental issues associated with maritime transport. The introduction of oil into the sea has devastating effects for marine ecosystem as crude oil and its products are toxic to marine life, causing diseases, abnormal reproductive cycles, and even extinction, and their components stay in the sediment for extended periods. The Baltic Sea due to its natural characteristics (low salinity, small water volume, slow water exchange, archipelago coastline, ice cover during winter) has a particularly sensitive ecosystem highly vulnerable to oil pollution.

Intensification of oil carriage by sea is associated with a risk of increased number of accidents, and increase in size of tankers can increase the size of spills. According to statistics provided by HELCOM, the number accidents on the Baltic Sea varied despite the efforts to improve navigational safety. There is no coherent statistics on incidents and near misses available, since in the shipping industry incident and near miss reporting is largely underdeveloped and/or conducted internally without making results publicly available (Lappalainen et al. 2011). According to HELCOM annual statistics, the most common types of accidents are grounding (almost in 50% of all cases) and collision with another vessel or a fixed structure. Cargo vessels are the main group of ships involved in accidents, followed by passenger ships and tankers. Given the steady increase in the number of ships at sea, including oil tankers, it can be inferred that the share of tankers involved in accidents (with or without pollution) has remained stable.

Table 1. Number of reported accidents in the Baltic Sea, 2006-2012

Year	Number of accidents	Resulted in pollution (N)	Not identified. (N)	Involving tanker (%)	Number of ships
2006	110	5	2	15	9,077
2007	114	4	2	13	10,041
2008	125	9	1	10	11,359
2009	95	10	0	19	11,661
2010	111	10	3	10	12,596
2011	72	11	38	13	15,247
2012	148	10	1	10	15,350
2013	150	6	1	10	17,380

Note: Reporting for all tankers larger than 150 DWT and other vessels 400 DWT. The number of ships is reported on the basis of AIS data.

Source: HELCOM Accidents (<http://helcom.fi/baltic-sea-trends/maritime/accidents/>) and Johansson and Jalkanen (2015).

Apart from accidents, oil pollution can result from routine tanker operations (e.g., release of oily ballast water), as well as from discharges produced by non-tankers in the case of oily bilge water, deballasting fuel tankers and accidents. Though any oil discharge into the Baltic Sea, including crude oil, fuel oil, oil sludge, or refined products, is prohibited, this rule is regularly violated. Despite rapidly growing density of shipping, a decreasing trend can be observed in regard to illegal oil discharges (HELCOM 2015b).

Table 2. Illegal oil discharges and aerial surveillance in the Baltic Sea

Year	Total number of illegal oil discharges observed in national waters	Total number of aerial surveillance flight hours performed by the HELCOM countries
2000	472	5230
2001	390	4837
2002	344	4864
2003	278	4946
2004	293	5534
2005	224	5638
2006	236	5128
2007	238	3969
2008	210	4603
2009	178	5046
2010	149	4279
2011	122	5541
2012	139	5090
2013	130	4317
2014	117	3935

Source: HELCOM (2015b, p.8).

Altogether 117 oil spills were recorded in 2014, which is an obvious decrease in comparison to the average of ca. 400 in the beginning of the 2000s (Table 2). This development is associated with increased frequency of the surveillance flights and improved usage of remote sensing equipment (HELCOM 2015b). Apart from surveillance, the decreasing trend can also be attributed to a complex Baltic Strategy to prevent illegal discharges of oil and waste into the sea, which included a ‘no-special-fee’ system for using port reception facilities (PRF), where adequate treatment of waste is provided (The Baltic Sea Portal 2009). The significant renewal rates of the Baltic fleet could have also had an impact as newer vessels are equipped with systems capable of treating wasteful products on board or retaining them safely until they are discharged to PRFs.

2.2. Air pollution

Shipping is a significant contributor to local atmospheric problems – as well as to global environmental issues such as climate change – as a result of emissions and discharges into air. Smog-forming nitrogen oxides, sulphur dioxide, which forms harmful fine particles and falls back to earth as acid rain, and particulate matters causing respiratory problems and thousands of premature deaths every year (Corbett et al. 2007), respiratory, allergic, and immune effects associated with man-made volatile organic compounds, constitute only a part of a list of harmful impacts of shipping emissions. Large diesel engines of the sea-vessels are responsible for ca. 3% of the overall CO₂ pollution (Smith et al. 2014). Technically, air pollution from shipping can be further reduced through engine optimisation, hull and propeller modernisation, slow steaming, as well as switch from the old-fashioned engines fuelled by heavy fuel oil (HFO) to those powered by marine gas or diesel oil (MGO/MDO), liquefied natural gas (LNG), hydrogen and other alternative fuels, or even by wind and wave powers.

In the Baltic Sea area, HELCOM has co-ordinated regular air emission assessment starting from 2006 (Table 3).

Table 3. Air emissions from Baltic shipping, 2006-2014 (tonnes)

Year	NO _x	SO _x	PM	CO ₂
2006	327,000	136,800	29,100	15 779,400
2007	350,800	126,700	28,300	16 850,900
2008	357,600	129,900	29,100	17 462,500
2009	336,000	122,300	27,500	16 684,600
2010	346,500	92,600	23,500	17 458,700
2011	377,000	86,500	23,700	19 239,700
2012	369,600	83,700	23,100	19 012,800
2013	323,200	80,200	16,100	15 343,000
2014	322,529	81,845	16,210	16 088,000

Note: Transport work of vessels with an IMO number based on AIS position data, small vessels are not included. Estimates are based on the STEAM model (Jalkanen et al. 2009). Emissions estimated for nitrogen oxides (NO_x), sulphur dioxide (SO_x), particulate matters (PM), carbon dioxide (CO₂).

Source: Johansson and Jalkanen (2015) and HELCOM (<http://www.helcom.fi/baltic-sea-trends/environment-fact-sheets/>.)

Starting from 2007, emissions of SO_x and PM from shipping have gradually decreased. This trend is associated with the entrance into force of the Baltic Sea Sulphur Emission Control Area during 2006 and the reviewed EU directive 2005/33/EC (the so-called ‘sulphur directive’), which starting from year 2010 prescribed all ships to switch to less than 0.1 sulphur content fuel in ports if their hoteling period is longer than two hours (Jalkanen and Johansson 2013). Emissions of NO_x and CO₂ were variable. It is important to note, that during the whole time that the intensification of shipping was registered, indicating both relative and absolute decrease of emissions due to the use of innovative technology (such as alternative marine fuels, shore-side electricity, fuel-saving measures, slow-steaming) and/or improvements in regulatory compliance.

2.3. Waste and discharge pollution

Marine litter from shipping includes items that have been made or used by people and deliberately discarded (solid waste dumping or macerated waste discharge, e.g. sewage sludge) or unintentionally lost (cargo loss) into the sea (GESAMP 2015). Until relatively recently, the ocean was widely used as a convenient place for garbage disposal; the problem of illegal dumping persists. Large and small pieces of floating plastic (incl. microplastic) in the surface ocean contribute to contamination of marine ecosystem. In the Baltic Sea region, the situation in waste and sewage treatment has improved in the past decade. In 2007, HELCOM proposed at the IMO to create a special area under MARPOL Annex IV in the Baltic Sea and improve port reception facilities (PRF). In July 2011, the IMO approved the Baltic Sea as a special area under Annex IV and added new discharge requirements for passenger ships while in a special area. The special area status entered into force on 1.1.2013, and from that date onwards discharge of sewage into the sea from passenger ships is prohibited (unless an on board sewage treatment plant is used), and all untreated sewage is to be delivered to an onshore PRF. At the same time, starting from 2010 a HELCOM roadmap for upgrading the availability of port reception facilities for sewage in major passenger port was put into action. The co-operation on PRF under HELCOM encouraged shipping companies and ports to

undertake voluntary activities and to dispose sewage to PRF, with the largest passenger ports in Stockholm, St. Petersburg and Helsinki setting an example.

Water as a ballast has become common in shipping, starting with a proliferation of steel hull technology more than hundred years ago, however, the problem of invasive species in ships' ballast water appeared on the agenda of international maritime community only in the 1980s. Ballast water discharges usually contain a variety of biological material, including non-native (alien) species that can cause environmental and economic damage by disrupting aquatic ecosystems, thereby posing hazards to native species, human health, and commercial activities such as fisheries and aquaculture. As the International Ballast Water Management Convention (BWMC 2004) has not entered into force yet, the HELCOM prepared a Ballast Water Road Map that has been signed by all member states. Furthermore, Guidelines for the common harmonised implementation of the BWMC were prepared and tested (HELCOM 2014). Despite proactive approach, due to *“the lack of data on the presence and distribution of harmful species in Baltic Sea ports and their vicinity, i.e., where ballast water operations occur”* the effectiveness of these regulation and measures undertaken remain difficult to assess (David et al. 2013, p. 207).

2.4. Noise and vibration

The awareness of the negative environmental effects of noise and vibration produced by seagoing vessels is relatively new to the wider public. Ambient noise from shipping is a well-recognised problem, seen in relation to health of mariners and inhabitants of areas adjacent to ports, and attempts to mitigate these effects, including shore-side energy supply for vessels in ports, are undertaken. The negative effects of the underwater noise harmful for marine animals are less well studied, yet, it has been demonstrated that the major source of human-induced underwater noise in the Baltic Sea is the underwater noise generated by commercial vessels (HELCOM 2014). At present, there is no regular environmental monitoring of noise in the Baltic Sea region.

3. International environmental regulation of shipping

Rules and regulations addressing adverse social and environmental effects of shipping constitute an important part of contemporary maritime governance architecture. In 1949, the Intergovernmental Maritime Consultative Organization (IMCO, subsequently International Maritime Organization, the IMO) was established as a specialised UN agency operating with a mandate to global standard-setting for the safety and security of shipping and the prevention of marine pollution by ships. The IMO took a lead in developing a system of international, regional, and national agreements to protect global oceans from the introduction of pollutants, and species inhabiting its waters from disturbances. The cornerstones of this system are the United Nations Convention on the Law of the Sea (UNCLOS 1982) and the International Convention for the Prevention of Marine Pollution from Ships (MARPOL 1973/1978). Additionally, there are specified legal instruments for different types of pollution on the international, regional, and national levels, which include both framework instruments on marine environment protection and concrete provisions setting emission standards, prohibiting certain operations, or providing penalties in the event of polluting discharges.

MARPOL 73/78 is one of the most important international marine environmental conventions that aims to prevent and minimise both accidental pollution from ships and that stemming from routine operations

(Knapp and Franses 2009). All parties to MARPOL 1973/78 to MARPOL 73/78 must mandatorily accept Annex I (Regulations for the prevention of pollution by oil) and Annex II (Regulations for the control of pollution by noxious liquid substances in bulk). Annexes III to VI (Prevention of pollution by harmful Substances Carried by Sea in Packaged Form, Prevention of Pollution by Sewage from Ships, Prevention of Pollution by Garbage from Ships, and Prevention of Air Pollution from Ships) are voluntary. Though MARPOL is a global instrument, it allows introducing regional arrangements, such as 'special areas', or areas that require additional methods and instruments for the prevention of sea pollution due to their oceanographic or ecological condition. Among other international legal instruments that address vessel-based pollution are The Convention on the Prevention of Marine Pollution by Dumping of Wastes and Other Matter 1972 (the London Convention, The International Convention for the Safe and Environmentally Sound Recycling of Ships 2009 (the Hong Kong Convention), and the International Convention for the Control and Management of Ships' Ballast Water and Sediments 2004 (BWM Convention),

International regulation of vessel-based oil spills is most comprehensive, tight, and restrictive when compared to the regulation of other types of pollutants. Due to the significance and scale of environmental consequences associated with accidental oil pollution, tanker accidents happened to become a legislative driver for a number of international maritime conventions. The International Convention on Civil Liability for Oil Pollution Damage (CLC 1969), often considered to have been initiated due to the Torrey Canyon accident in 1967, introduced liability for damage from oil pollution resulting from tanker accidents, placing responsibility upon the owners of the ship, who can limit their liability in accordance with established procedures. The Protocol of 1992 to CLC 1969 changed compensation limits, widened the scope to cover exclusive economic zones (EEZ), and established higher limits of liability. In order to cover oil pollution that does not result from tanker casualties, the International Convention on Civil Liability for Bunker Oil Pollution Damage as an instrument analogous to CLC 1969 was adopted in 2001 (and entered into force 2008). The Exxon Valdez accident in 1989 prompted the US Oil Pollution Act (1990), the International Convention on Oil Pollution Preparedness, Response and Co-Operation (OPRC 1990), and amendments to MARPOL regarding the phase-out of single-hull tankers. The sinking of Erika in 1999 set off the EU legislative process, resulted in so-called Erika Packages, and already mentioned Prestige spill in 2002 accelerated phase-out of single-hull tankers in European waters.

Whereas the overall structure of regime addressing adverse environmental effects of shipping is set through a system of universal agreements, regional arrangements can be developed under the auspices of the IMO to account for local specificities. First, the IMO foresees the ascribing the status of particularly sensitive sea area (PSSA). A PSSA is an area that needs special protection because of its significance for recognised ecological or socio-economic or scientific reasons. In practical terms, a PSSA gives a possibility to introduce associated protective measures (APMs) to be implemented jointly under the PSSA umbrella. APMs include specific ways of controlling the maritime activities in the PSSA, such as routing measures, discharge, and equipment requirements for ships. The first PSSA, the Great Barrier Reef in Australia, was designated in 1990. The Baltic Sea, except for Russian waters, received a PSSA status in 2005.

Second, the instrument of emission control areas (ECAs) was developed by the IMO as a part of progressive emission reduction policy in the framework of the MARPOL 1973/78 Convention. For the time being, four areas designated as ECAs, among them the Baltic Sea, the North Sea, the North American EEZ and the Californian Coast, have become SO_x control areas, which effectively means a cap on the maximum sulphur content of the fuel oils as loaded, bunkered, and subsequently used onboard (Table 4). Consequently, ECAs will also feature more stringent standards for NO_x emissions. MARPOL Annex VI

BSR Policy Briefing 1/2016

NOx reduction scheme foresees three different levels of control (so-called tiers) applied basing on the ship construction date. Whereas Tier II is applied to all vessels constructed after 1.1.2011, the Tier III limits adopted in 2008 were to be applicable to ships built from 2016 when sailing in ECAs. In 2013, the IMO has decided to postpone the entry into force of the Tier III NOx emissions limits for ship engines from 2016 to 2021.

Table 4. MARPOL Annex VI: ECA regulation of sulphur content in fuel oil

Global cap	SECA
4.50% m/m prior to 1 January 2012	1.50% m/m prior to 1 July 2010
3.50% m/m on and after 1 January 2012	1.00% m/m on and after 1 July 2010
0.50% m/m on and after 1 January 2020 ¹	0.10% m/m on and after 1 January 2015

Note: The unit ‘% m/m’ means ‘percent by mass’.

Source: IMO

(<http://www.imo.org/en/OurWork/Environment/PollutionPrevention/AirPollution/Pages/Sulphur-oxides-%28SOx%29-%E2%80%93-Regulation-14.aspx>).

In addition to limitation of SOx and NOx emissions, GHG emissions are addressed by the MARPOL Annex VI. Chapter 4 of MARPOL Annex VI introduced two mechanisms to ensure an energy-efficiency standard for ships: (1) the Energy Efficiency Design Index (EEDI), for new ships, and (2) the Ship Energy Efficiency Management Plan (SEEMP) for all ships, applicable to all ships of 400 gross tonnage from 1.1.2013. The EEDI is a mandatory tool to improve the energy efficiency of vessels and thereby reduce their CO₂ emissions. The idea of this design index is to provide a measure of how much CO₂ is produced per amount of transportation performed with a final goal of optimising marine engines. The SEEMP, instead, includes a number of measures that can allow ships to improve their performance in terms of CO₂ emissions, such as raise the efficiency of fuel operations, optimise ship handling, hull, propulsion, machinery and equipment, handling of cargo, as well as prevent energy losses and increase energy conservation through raising awareness. Slow steaming and shore-side power supply are among the prominent measures that received wide reception among shipping companies.

In addition to local instruments developed under the auspices of global organisations, genuinely regional instruments play no less important a role in specifying the shipping governance structure in terms of mechanisms, instruments, and implementation entities. The Baltic Sea Helsinki Convention 1992 governed by Helsinki Commission (HELCOM) is a special instrument developed in the Baltic Sea region that aims at improvement of the status of the Baltic Sea, among other things, addressing emissions and discharges from maritime transport. Some of the provisions of the Helsinki Convention go beyond global regulation, for example, it has taken a progressive stance in matters of ballast water treatment and introduced a no-special-fee system for port reception facilities (PRF, where ships can leave their solid and liquid waste generated on board during the voyage) in order to address the problems of sewage and garbage pollution. Since 2005, when amended Annex I of the MARPOL Convention and EU Regulation (EC) No 1726/2003 entered into force, single-hulled tankers have been completely banned from carrying heavy grade oil to and from European ports. In the Baltic Sea, HELCOM in co-operation with the European Maritime Safety Agency (EMSA) introduced a monitoring system to strengthen the enforcement of international rules. The national and regional traffic monitoring systems of the Baltic Sea, integrated in the HELCOM Automatic Identification System (AIS), were used to control shipping traffic and make the

¹ Depending on the outcome of a review, to be concluded by 2018, as to the availability of the required fuel oil, this date could be deferred to 1 January 2025.

ban effective. HELCOM also took an active part in development of navigational aids (vessel traffic services (VTS), traffic separation schemes (TSS), and the like), that help to ensure maritime safety and protect the sea from accidental pollution.

4. The interplay of public and private initiatives in shipping environmental governance

On the one hand, shipping is one of the most regulated global industries, at least regarding the number of legal acts (Portsmouth et al. 2012). At the same time, significant discrepancies in enforcement practices and implementation rates of shipping regulation are observed (Bloor and Sampson 2009; Knudsen and Hassler 2011). Whereas non-governmental organisations and media have had very little visible on creating public awareness for negative environmental impacts of shipping operations, shipping stakeholders themselves regularly communicate on the pitfalls of global shipping regulation. Self-regulatory measures were developed by the shipping industry actors in co-operation with each other, as well as in collaboration with public sector and non-governmental organisations.

The HELCOM Baltic Sea Action Plan (BSAP) and the EU Strategy for the Baltic Sea region (EUBSRS) were essential for getting policymakers' attention to the environmental problems caused by shipping in the Baltic Sea. The BSAP highlighted the negative effects of shipping. It implicitly called for more effective implementation of existing regulation (especially, on the side of the IMO) and demonstrated that if global regulation is not effective enough, the EU and other regional actors are willing to take actions to prevent negative shipping externalities. The EUBSRS encouraged problems-solving through cross-border, collaborative projects where both public and private stakeholders are involved. Closer partnerships between national, regional and local administrations, research institutions, NGOs and representatives of the shipping industry (ship owners, ports, logistics companies) are desired since (sic): *“Joint efforts can allow private stakeholders to get a better understanding of regulations and standards while giving the public sector a first-hand information about market conditions and needs.”* (European Commission 2012, p. 7). The approach elaborated in these two strategies can be seen as an expression of the political and social pressure on shipping, inviting private actors to strengthen their role in maritime policymaking.

The private initiatives to promote environmentally-friendly shipping include Green Award, which aims to improve safety and environmental performance of the oil, chemical and bulk carriers, Clean Cargo working group, which is a global initiative to improve environmental performance of container transport especially regarding carbon-dioxide emissions, and two indexes, Clean Shipping Index (CSI) developed by Clean Shipping Project and Environmental Ship Index (ESI) developed by World Port Climate Initiative. The development of the two indexes (ESI and CSI) was primarily motivated by the need to increase transparency in shipping markets. The ESI is a voluntary measure aimed to improve the environmental performance of vessels. The ESI evaluates the amount of nitrogen oxides (NO_x), sulphur oxides (SO_x) and carbon dioxide (CO₂) that are released by a ship, compares the metrics to the current IMO requirements, and establishes a reporting scheme. The CSI is a competing instrument with very similar targets. Unlike the port initiated ESI, CIS was initiated and supported by public authorities in Sweden and run by a non-profit association. In a similar fashion as the ESI, the CSI gives a rating to ships and shipping companies based on their environmental performance, thereby giving a tool to cargo owners and transport purchasers to select environmentally well-performing shipping services and minimise the environmental footprint in their supply chain.

Furthermore, self-regulation and third-party certification is spreading along the supply chains and across industries. In shipping segments that are most 'risky' (such as oil and chemical transports, see Frynas (2012) vetting inspections, that is inspections performed on behalf of oil majors and/or terminal operators by an independent third party with a goal to establish seaworthiness of a vessel and prove trustworthiness of previous inspection efforts, are the cornerstone to ensuring safety and environmental quality of shipping operations (Gritsenko 2015). Container carriers are among the early adopters of corporate social responsibility (CSR), voluntary initiatives when private firms assume the responsibility for improving their negative social and environmental impacts. Consumers and NGOs are increasingly demanding traceability and transparency on the products life-cycle, including transportation (Pawlik et al. 2012). Shipping operators started to report about their environmental, safety performance and other activities under the label 'CSR' because cargo-owners asked for this information.

Even though many private maritime stakeholders in the BSR take proactive approach to mitigation of shipping pollution, it shall be reminded that these self-regulatory approaches developed in the shadow of tight emission regulations and monitoring efforts by regional and local authorities (Yliskylä-Peuralahti and Gritsenko 2014). The constantly rising energy costs and need to improve maritime safety are the main motivations for self-regulation in the maritime sector, with positive spillovers that diminish environmental damages. Though voluntary self-regulation in shipping at large is marginal, in certain areas (e.g., emission control areas, regions with effective sanctioning mechanisms like EU ports, and regions with strong environmental consciousness and public awareness like in the Nordic countries) private efforts are noticeable. Since maritime transport is a mobile industry, vessel owners and operators from these 'special' regions increase pressure on the vessel owners/operators in other areas to redeem a greater equality of the shipping markets (e.g., Maersk in coalition with a few other companies demanded stricter regulation for the port area of Hong Kong and Singapore to restore the 'level-playing-field', Wang et al. 2013). Eventually, the global shipping industry is dominated by 'local cases', such as the Baltic Sea.

5. Towards effective environmental governance of Baltic shipping

Research: The EU Baltic Sea Region Strategy issued in 2009 set an ambitious goal to make the BSR a model region for clean shipping. Some progress has been made in this regard, yet, the interrelation of the ecological, economic and social impacts of shipping in the Baltic Sea are not fully understood. The main competitive advantage of shipping as a transport mode, its low cost, has been realised because the cost of the negative environmental impacts of maritime transport was largely neglected. In order to meet the regional demand for trade in goods without compromising the state of environment, additional research is needed to provide in-depth assessment of policy options to mitigate environmental pressure linked to shipping.

Regional governance: The hierarchically organised regulatory system based on subordination of levels of authority has been acknowledged as inappropriate to cope with the reality of shipping as a globalised business with transboundary adverse effects (Roe 2012). In the BSR, the HELCOM plays an essential role in crafting mechanisms for regional adaptation of global protection regime established by the IMO. It is essential that HELCOM will continue its work in assessment of Baltic maritime activities, their environmental impact, the status of implementation of existing regulation, as well as drawing recommendations the emphasise the special needs in accordance with the changing ecological status of the sea.

Targeting: Shipping as a commercial activity carried out in the Baltic Sea is not homogeneous: each type of shipping is engaged in a different supply chain depending on the type of transported commodity. Better understanding of operational processes typical of different types of shipping can help address environmental risks in a more specific manner. The three largest groups of Baltic commercial shipping are cargo carriers (dry bulk, break bulk and general cargo), tankers (oil, chemical, product) and container vessels, together accounting for almost 75% of all IMO registered vessels (Johansson and Jalkanen 2015). These segments of shipping are dissimilar, as they serve different value chains, the types of ships have their operational strengths and risks, and the scope of public and private regulatory initiatives varies. Targeting means giving incentives to actors to realise their governing potential and take responsibility for environmentally-friendly operations.

Digitalisation: Digital technologies continue to transform industrial processes all over the world. Shipping is a latecomer to the digital world, but for a good reason: connectivity at sea has been limited until very recently. With improving satellite data transmission and rapidly decreasing costs of sensors, the door is opening for maritime internet of things (IoT). The benefits of ships becoming data-smart are not only in new business opportunities in transport and logistics, but also in addressing ship performance, safety, and energy efficiency. Intelligence built on top of big data collected by sensors installed on ships open up new possibilities for environmental monitoring. For the new information design in shipping will ensure transparency, enable public scrutiny and make shipping more environment-friendly, proactive policy intervention is required to ensure access to data for all relevant stakeholders.

References

- Bloor, M., Sampson, H., 2009, Regulatory Enforcement of Labour Standards in an Outsourcing Globalized Industry the Case of the Shipping Industry. *Work Employment Society* 23, 711–726.
- Brunila, O-P., Häkkinen, J. and Kunnaala, V. 2014. Future oil transportation volumes in the Gulf of Finland: Policies needed to prevent the risks of oil transportation. *BSR Policy Briefing 2014/1: The Baltic Sea region 2014: Ten policy-oriented articles from scholars of the University of Turku.*
- Corbett, J.J., Winebrake, J.J., Green, E.H., Kasibhatla, P., Eyring, V., Lauer, A., 2007. Mortality from Ship Emissions: A Global Assessment. *Environ. Sci. Technol.* 41, 8512–8518.
- David, M., Gollasch, S., Leppäkoski, E., 2013. Risk assessment for exemptions from ballast water management – The Baltic Sea case study. *Marine Pollution Bulletin* 75, 205–217.
- EUNETMAR, 2013. Study on Blue Growth, Maritime Policy and the EU Strategy for the Baltic Sea Region. Online. https://webgate.ec.europa.eu/maritimeforum/sites/maritimeforum/files/Final%20Executive%20Summary%20Revision%206%20Dec%202013_NEW%20TEMPLATE%20%28%29.pdf
- European Commission, Communication from the Commission to the European Parliament the Council, the European Economic and Social Committee, and the Committee of the Regions concerning the European Union Strategy for the Baltic Sea region. COM(2012)128 final. Date of access: 25/02/2013. at: http://ec.europa.eu/regional_policy/sources/docoffic/official/communic/baltic/com_baltic_2012_en.pdf.
- Frynas, J.G., 2012, Corporate Social Responsibility or Government Regulation? Evidence on Oil Spill Prevention. *Ecology and Society* 17.
- GESAMP, 2015. Sources, fate and effects of microplastics in the marine environment: a global assessment. Kershaw, P. J., (ed.) IMO/FAO/UNESCOIOC/UNIDO/WMO/IAEA/UN/UNEP/UNDP Joint Group of Experts on the Scientific Aspects of Marine Environmental Protection. Rep. Stud. GESAMP No. 90.
- Gritsenko, D. 2015. Quality governance in maritime oil transportation: the case of the Baltic Sea. *Management of Environmental Quality: An International Journal*, 26(5), 701-720.
- Hassler, B. 2011. Accidental versus operational oil spills from shipping in the Baltic Sea: risk governance and management strategies. *Ambio*, 40(2), 170-178.
- HELCOM, 2015b, HELCOM Annual report on discharges observed during aerial surveillance in the Baltic Sea, 2014.
- HELCOM, 2009. Overview of the shipping in the Baltic Sea. http://www.helcom.fi/stc/files/shipping/Overview%20of%20ships%20traffic_updateApril2009.pdf.

BSR Policy Briefing 1/2016

- HELCOM, 2014. HELCOM Guide to Alien Species and Ballast Water Management in the Baltic Sea. Online. <http://www.helcom.fi/Lists/Publications/HELCOM%20Guide%20to%20Alien%20Species%20and%20Ballast%20Water%20Management%20in%20the%20Baltic%20Sea.pdf>.
- HELCOM, 2015a. Updated Fifth Baltic Sea pollution load compilation (PLC-5.5). Baltic Sea Environment Proceedings No. 145. http://helcom.fi/Lists/Publications/BSEP145_Lowres.pdf
- IMO. Online. <http://www.imo.org/en/OurWork/Environment/PollutionPrevention/AirPollution/Pages/Sulphur-oxides-%28SOx%29-%E2%80%93-Regulation-14.aspx>.
- Jalkanen, J.-P. and Johansson L. 2013. Emissions from Baltic Sea shipping 2012. HELCOM Baltic Sea Environment Fact Sheets. Online. Available from: <http://www.helcom.fi/baltic-sea-trends/environment-fact-sheets/>.
- Jalkanen, J.-P., Brink, A., Kalli, J., Pettersson, H., Kukkonen, J., Stipa, T., 2009. A modelling system for the exhaust emissions of marine traffic and its application in the Baltic Sea area. *Atmos. Chem. Phys.* 9, 9209–9223.
- Johansson, L. and Jalkanen, J.-P., 2015. Emissions from Baltic Sea shipping in 2014. HELCOM Baltic Sea Environment Fact Sheets. Online. <http://www.helcom.fi/baltic-sea-trends/environment-fact-sheets/>.
- Knapp, S., and Franses, P. H., 2009. Does ratification matter and do major conventions improve safety and decrease pollution in shipping?. *Marine Policy*, 33(5), 826-846.
- Knudsen, O.F., Hassler, B., 2011, IMO legislation and its implementation: Accident risk, vessel deficiencies and national administrative practices. *Marine Policy* 35, 201–207.
- Lääne, A. 2001. Protection of the Baltic Sea: The role of the Baltic marine environment protection commission. *AMBIO: A Journal of the Human Environment*, 30(4), 260-262.
- Lappalainen, J., Vepsäläinen, A., Salmi, K., & Tapaninen, U. 2011. Incident reporting in Finnish shipping companies. *WMU Journal of Maritime Affairs*, 10(2), 167-181.
- Pawlik, T., Gaffron, P. & Drewes, P.A., 2012. Corporate Social Responsibility in Maritime Logistics. In Song, D-W. and Panayides, P.M. (ed.) *Maritime logistics: Contemporary issues*. Emerald Group Publishing Limited. UK 2012.
- Portsmouth, R., Hunt, T., Lind A., Nõmmela, K., 2012, Analysis of barriers caused by administrative, security and safety procedures in Pentathlon. Estonian Maritime Academy, Research and Development Centre. Date of access: 20/02/2013. <http://www.ematak.ee/p-1/penta>.
- Roe, M., 2012, *Maritime Governance and Policy-Making*. London: Springer.
- SHEBA - Sustainable Shipping and Environment of the Baltic Sea region, 2015. <http://www.sheba-project.eu/>
- Smith, T. W. P., Jalkanen, J. P., Anderson, B. A., Corbett, J. J., Faber, J., Hanayama, S., ... & Raucchi, C. (2014). Third IMO GHG study 2014. *International Maritime Organization (IMO)*, London, <http://www.iadc.org/wp-content/uploads/2014/02/MEPC-67-6-INF3-2014-Final-Report-complete.pdf>.
- The Baltic Sea Portal, 2009. HELCOM achieves another decrease in the number of illicit oil spills in the Baltic. 24.8.2009. Available from: http://www.itameriportaali.fi/en/ajankohtaista/uutisia_muualta/2009/en_GB/oil/.
- Wang, J., Park, K. & Khan, N., 2013, Maersk wants Hong Kong to ban dirty fuel to fight smog, January 6. Date of access: 21/02/2013. Online. <http://www.bloomberg.com/news/2013-01-06/maersk-wants-hong-kong-to-ban-dirty-fuel-to-fight-smog.html>.
- Yliskylä-Peuralahti, J., & Gritsenko, D. (2014). Binding rules or voluntary actions? A conceptual framework for CSR in shipping. *WMU Journal of Maritime Affairs*, 13(2), 251-268.

From tanker safety to ENSI service

Mikko Klang and Pekka Laaksonen ¹

1. Background

In 2007, after a navigation error, an oil tanker ran aground on a shoal in the Gulf of Finland. The vessel's cargo consisted of 100,000 tonnes of crude oil, but thanks to the double-hull structure of the ship, none of it was spilled to the sea. The erroneous route had been selected already when the journey was being planned, and the same plan had been used before, so it was a matter of pure luck that the vessel had not ran aground before.

In marine traffic, the destination, draught and estimated time of arrival of a ship are generally known via e.g. the Automatic Identification System (AIS); routes are mostly well-known, and partly restricted by fairways and traffic separation schemes; and the traffic, particularly in the Gulf of Finland, is closely monitored. There is, however, a lot of traffic – in 2012 oil transportation alone accounted for more than 150 million tonnes – and compared to larger seas, conditions are often navigationally challenging. Even a small probability is enough to lead to an inevitable mistake from time to time.

Unlike in aviation, precise marine traffic route plans are not distributed outside the vessel prior to the journey. In the case described above, any expert familiar with the area would have realised with one glance that the route plan was unacceptable for the draught of the loaded vessel. For ballast alone, the route would have been just fine.

The accident made the John Nurminen Foundation think about what actually happened in the situation, and whether could something be done to the causes of the incident. At first, the chain of events was pondered over by a small group. As ideas matured, an actual systematic pre-study began in 2008, as soon as the right person for the job had been identified.

2. Implementation

To kick off the pre-study, the Foundation's core team began collecting ideas and building a network for their further processing. At this point, only the goal was clear: to prevent oil spill accidents in the Gulf of Finland. All ideas were welcome, and during the networking phase quite a few were actually being thrown around. All authorities, non-governmental organisations (NGOs), research institutes, and commercial parties who were stakeholders in marine security joined the co-operation network, as did a few dedicated private individuals. All participants donated their effort to the project.

¹ With thanks to the service creators: Aboa Mare, Adage, Arctia Icebreaking, Capgemini, Castrén & Snellman, Consilium Marine, the Finnish Border Guard, the Finnish Meteorological Institute, the Finnish Transport Agency, Finnpiilot Pilotage, Furuno, Kotka Maritime Research Centre, Navielektro, the Navy, Neste Oil, Nixu, Trafi, Twinspark Consulting Oy and VTT.

BSR Policy Briefing 1/2016

The project team visited the authorities' control centres, and journeyed on a tanker from Primorsk via Porvoo to Naantali. During the trip, the team learned about security-related procedures onboard tankers. The key stakeholder groups of oil transportation security were identified, and the project's scope was defined to be in the 'grey area' that brings together the authorities, commercial stakeholders and the bridge, which is, after all, accountable for operating the ship (Figure 1).

Figure 1. Key stakeholders

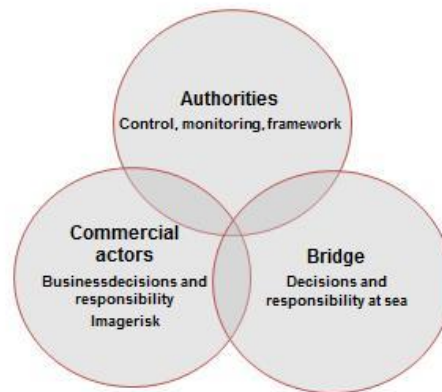

In April 2009, after the pre-study was completed, key people from the network were invited to a two-day workshop. At the workshop, all alternative ideas that had come up during the pre-study were assessed on the basis of their impact, feasibility, and compliance with the Foundation's project criteria (concrete actions, measurable impact on the status of the Baltic Sea, fast results, cost-efficiency, cross-border co-operation), and key partners for the implementation of potential solutions were identified.

Two of the project proposals identified in the workshop, 'Navigation Practices' and 'Culture of Safety' were developed further by the project team in the project planning phase (Figure 2). Both were assessed in particular in terms of their impact and feasibility. Developing a 'Culture of Safety' turned out to be a too large undertaking to be led by a small foundation, and it was also considered difficult to restrict the topic to be only about the Gulf of Finland.

Figure 2. Preliminary study

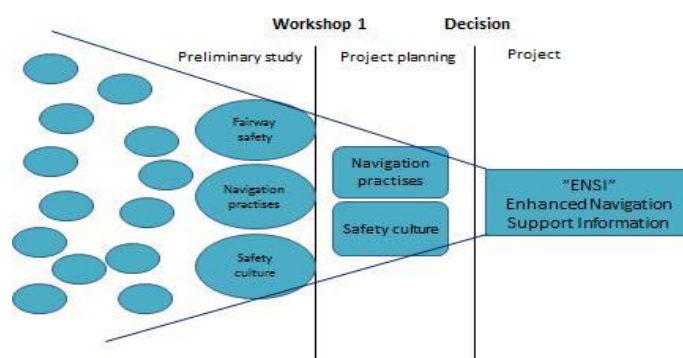

BSR Policy Briefing 1/2016

The project proposal on 'Navigation Practices' was developed further into an e-navigation service, for which a rough, high-level service concept was designed. The basic building block of the service concept was to utilise the ships' electronic route plans in the prevention of accidents.

Increasing amount of ships now had Internet connections; Electronic Chart Display and Information System (ECDIS) was becoming mandatory; and information that promoted safe navigation was being digitalised. By utilising these changes, it was possible to build a service that at the same time would improve safety, and make operations more efficient both onshore and on the ships' bridges. The service was dubbed Enhanced Navigation Support Information (ENSI) (Figure 3).

In October 2009, the Board of Directors of the John Nurminen Foundation approved the project as part of the Foundation's project portfolio. Although the Foundation's project focused on tanker traffic in the Gulf of Finland, the project team understood that scalability, in various dimensions, would be a requirement for service deployment (Figure 4). This requirement was integrated to service development.

An international standard for transferring route plans electronically did not yet exist, and to fill this gap the project developed a format that would be used until the international standard would be ready. In order to incorporate both viewpoints, specifications for the format were drawn up in co-operation with vessel traffic service (VTS) and ECDIS manufacturers. Test equipment was built, and sending routes both ways, from ships to shore and from the shore to the ship, was successfully tested. Route waypoints, recommended by icebreakers and sent to ships from the shore, were particularly useful to ships. The information was already in electronic format, which made using the route waypoints faster, and brought certainty that the ship had the very latest waypoint information at its disposal.

Already in the pre-study phase it became obvious that workloads on ship bridges continue to grow: any new practices made available to bridges should replace an existing procedure, and create added value for its users.

The decision was made to build the implementation of the service around usability, and hire a service design professional to work for the project. The second workshop of the project was organised in the spring of 2010. This workshop focused on specifying the contents of the service (Figure 5). Workshop participants included content providers, service users, service designers, equipment manufacturers, authorities, and commercial stakeholders.

After the workshop, work began on drawing up specifications for ordering the ENSI service, and building a user interface model. Experts from organisations in the project's co-operation network wrote the specification and created the content pro bono.

The user interface model was also created as pro bono work (Figure 6). A demonstrator was used, so user feedback could be collected already before starting the implementation of the service.

The user interface and specification were handed over to the Finnish Transport Agency, which, after a bidding process, ordered the implementation of the service. The ownership of the ENSI project with the whole responsibility of the development and implementation was transferred to the Finnish Transport Agency in 2014. The co-operation with the John Nurminen Foundation continues.

Figure 3. ENSI concept

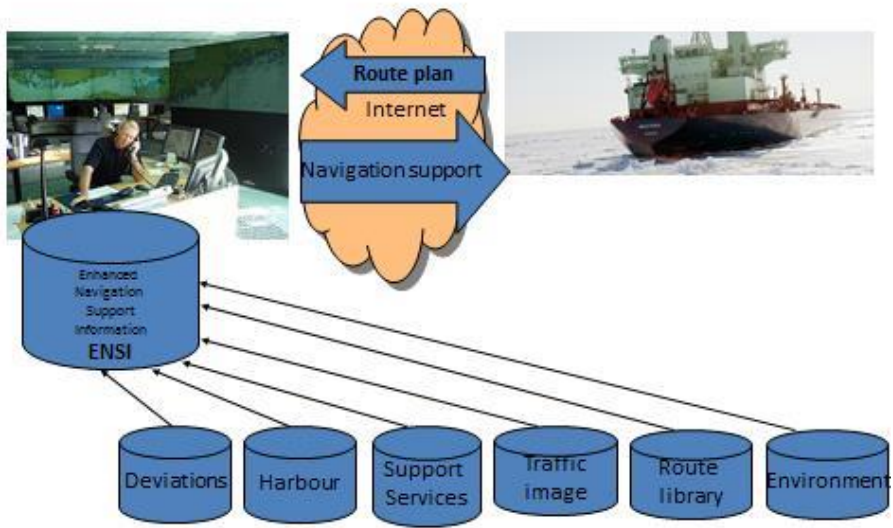

Figure 4. Scalability

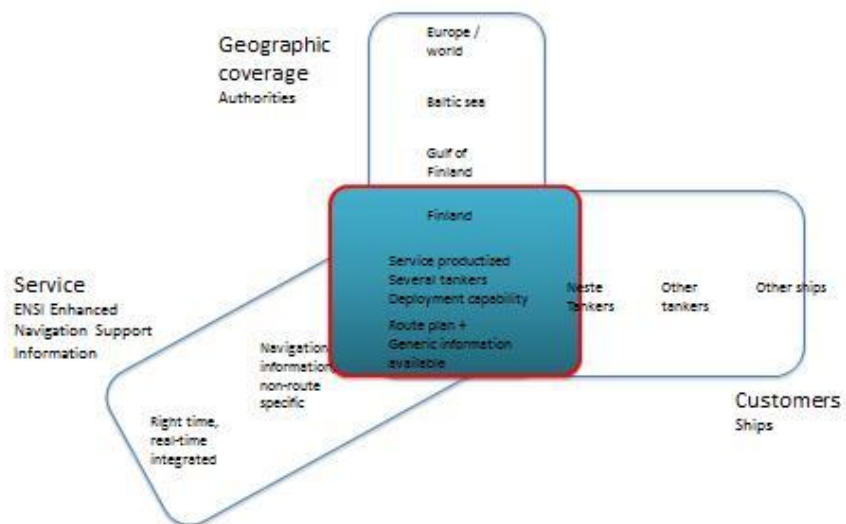

Figure 5. Workshop 2 focus

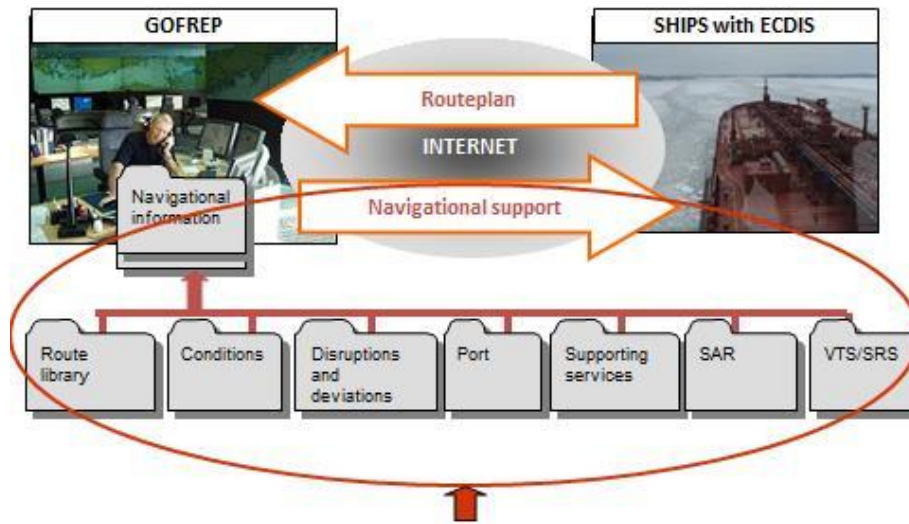
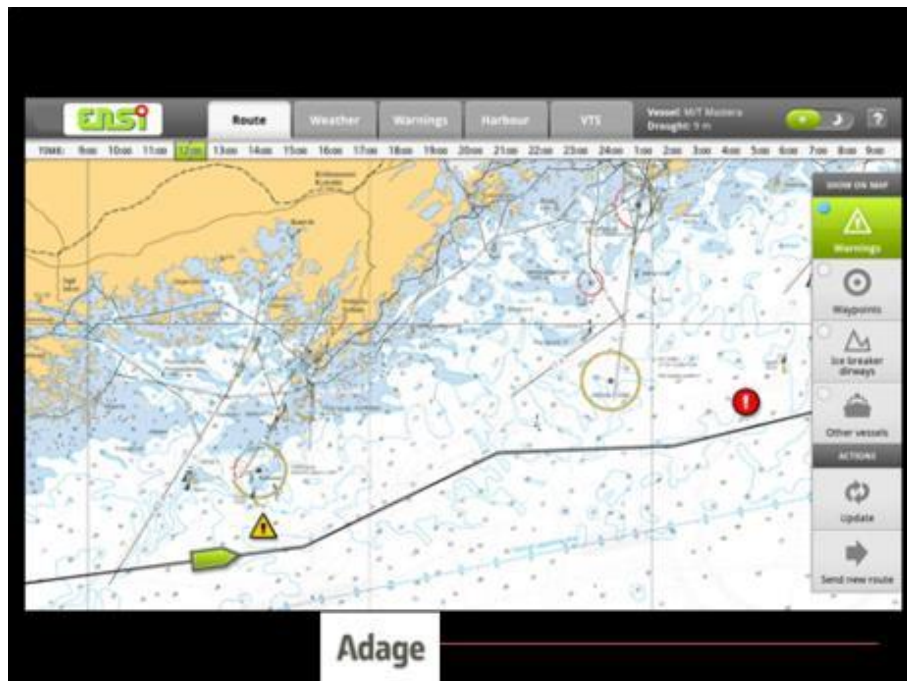

Figure 6. User Interface specification



3. Results

In the current ENSI service, a vessel's tactical route plan is sent out to maritime authorities (Figure 7). The safety of the route plan will be automatically re-checked. All anomalies or defects in the plan can be observed already at an early stage, and vessels will be notified of these observations. The aim is to reduce the risk of human errors made during route planning. Route plans received from vessels are also incorporated to VTS centres' real time traffic images (Figure 8) to help detect possible traffic congestions and risk situations in advance. Automatic deviation alarms will help the VTS operators focus their attention to areas where it is needed.

Figure 7. ENSI principal

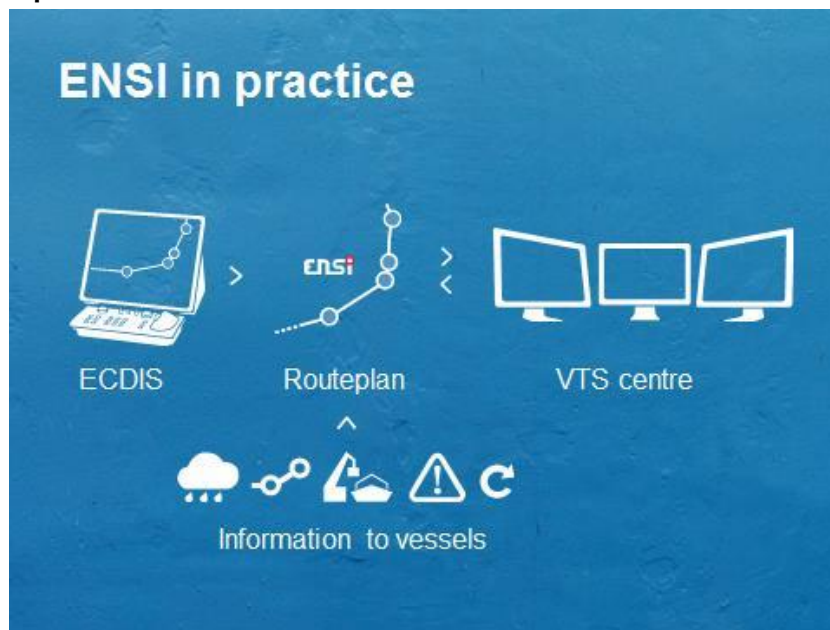
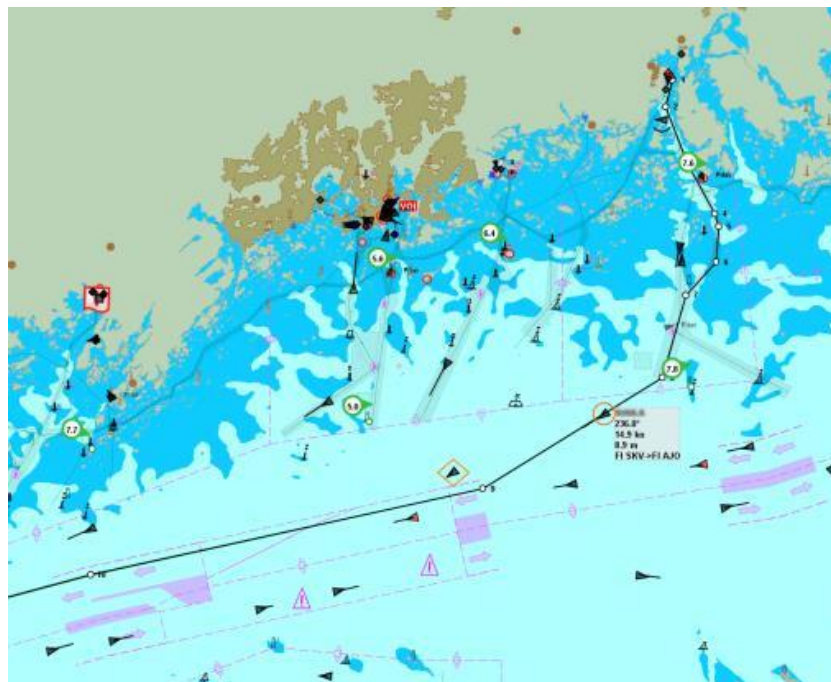
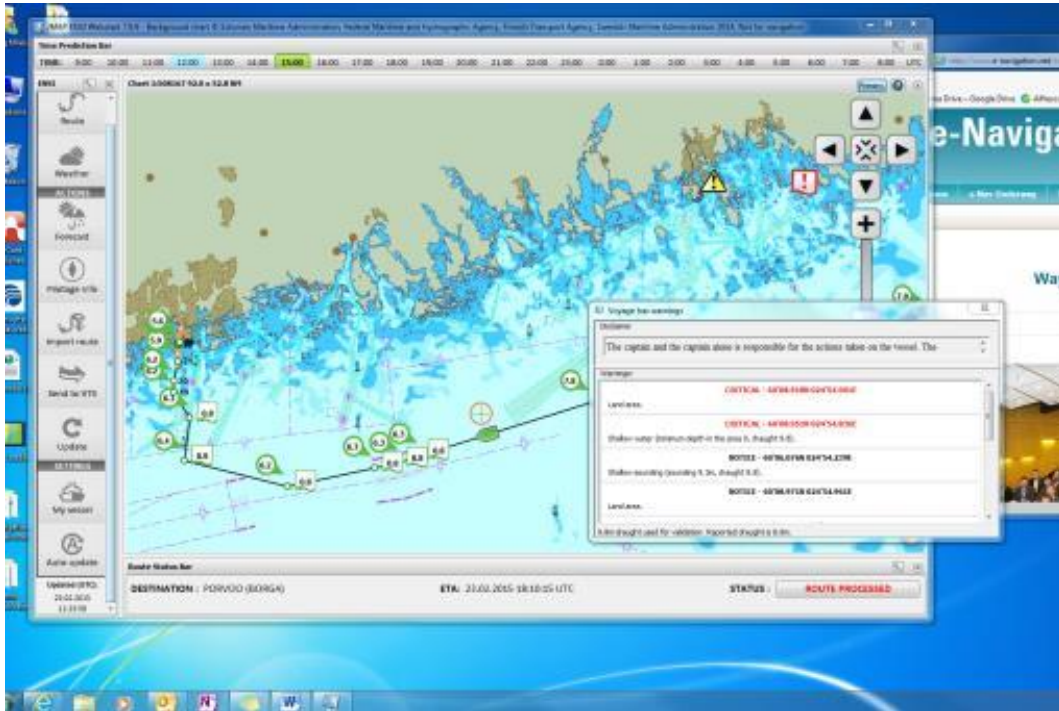

Figure 8. VTS view



The route plan that a vessel sends to the service is the same plan that is routinely made with ECDIS. They can send it to VTS using a simple chart application (Figure 9). At the same time, information required for the mandatory report for the Ship Reporting System in the Gulf of Finland, GOFREP, can be given with an unambiguous form. The aim is also to lessen the burden on board, as well as the need for VHF reporting. A pilot for Finnish harbours can also be ordered.

Figure 9. Ship's view



After the navigator has submitted the route plan, the IMO Standard Ship Reporting System report (SRS) and pilot order in one action, the result of the route check is presented in the chart application, making it easy for the navigator to visualise the feedback. Also other information, including information on weather and ice conditions, weather prognosis, ice waypoints, navigational warnings and possible other information about hazards or anything unusual along the route will be displayed on the chart.

4. Conclusions

The first successful ENSI installation onboard a ship was made in the turn of 2012-2013. Currently, the service is being tested by approximately twenty ships that sail the Gulf of Finland on a regular basis. In December 2015, 191 vessel reports and route plans were sent to the service. Several updates for the service have since been released: they focus on general operability, and making the service more stable and compliant with vessel systems. The user interface and the contents of the service have generally stayed as is, with no changes to the initial idea.

During 2016, the vessel traffic systems of other countries besides Finland will be able to join the service. Starting from the Gulf of Finland, the visibility of the service will be expanded in other countries of the Baltic Sea coastline. The Finnish Transport Agency, as the owner of the service, is a partner in several

BSR Policy Briefing 1/2016

international projects that promote e-navigation in the Baltic Sea area. In the next couple of years, these projects will test ENSI as part of other, wider-scope e-navigation systems; consequently, the user base of the service will expand considerably, both in number and geographically. At the same time, new users are recruited outside these projects.

ENSI stands out from other systems that are being developed simply because it works. It is still a testbed, to be sure, but one that is operational: A simple and straightforward service, utilising existing technologies on a practical level, making the deployment of route sharing possible already today. The service is a pioneer and pathfinder for more advanced systems as we await their completion. Furthermore, since ENSI is compliant with standards whenever this is possible, users find that updating the system to further matured service will not cause great changes in everyday life – things just start to work better.

Focusing on vessel route plans has been proven to be the most cost-efficient way to reduce the risk of accidents (Kotka Maritime Research Centre: MIMIC 2011-2013). Moreover, research results obtained with modelling indicate that deployment of the ENSI service could reduce the number of tanker accidents in marine traffic (Hänninen et al. 2013). ENSI or a similar service should, in fact, be deployed without delay on the vessel level. Although technologies are developing, each route plan sent to the service is checked automatically, with feedback sent to the vessel, and browsed through by a local expert from the visual user interface. A cross-checking process of this kind takes up almost no time, but improves the detection of errors in planning considerably. Also, automating the follow-up of vessel route plans introduces a new tool for VTS centres in areas with busy traffic.

The current users of the service consist predominantly of vessels and crews who sail mostly in the area of the Gulf of Finland and know the conditions there well. In terms of safety, random visitors to the marine area are the weakest link, as it is impossible to single them out from the flow of traffic. The only way to harvest the full benefits of the service is to make it mandatory, covering all vessels, regardless of type or visiting frequency; but the process is slow. It can be sped up by deploying high-quality services with easily identifiable added value and immediate benefit to users. Making vessel and cargo owners understand the value of an additional guarantee, and demanding that cargo transporters use these security-enhancing services even before they become mandatory, would be a great leverage point.

Various projects that seek to simplify route sharing and reporting are also ongoing elsewhere, around the world. Contrary to general expectation, the standard format of an electronic route file (RTZ) was published already in 2015, and integrated to the Performance Standard of ECDIS equipment. The standard will consequently spread to vessel use with new equipment acquisitions at the latest, and, most likely, with system updates at least for a share of existing equipment. This reform means that a route, saved with any navigation system, can be loaded, opened and scrutinised as such, using any navigation system.

More advanced route communications systems send and receive routes, make change suggestions, and approve, reject, edit and optimise routes. Information is also passed on through lengthy chains, attached even to the delivery plans of individual packages, from sender to the recipient. Changes to plans are distributed to departure and arrival ports and from there onwards and backwards to truck terminals, and so on. The general attitude the marine traffic industry has towards these kinds of developments is changing from resistance to expectancy. It seems that the world is ready for change. Learn more about the ENSI service at <https://ensi.fta.fi>

References

- Hänninen, M., Mazahori, A., Kujala, P., Montewkaz, J., Laaksonen, P., Salmiovirta, M. & Klang, M.: Expert elicitation of a navigation service implementation effects on ship groundings in the Gulf of Finland – Institution on Mechanical Engineers (September 3, 2013).
- Kotka Maritime Research Centre: MIMIC – Minimizing risks of maritime oil transport by holistic safety and security strategies. (2011-2013).

Passenger shipping on the Baltic Sea

Luulea Lääne

By 2016 AS Tallink Grupp has been around for 27 years and one of the major brands of the company, Silja Line is close to celebrating its 60th birthday. In comparison to historical brands it is not such a long time, but the developments, which have taken place during that time in maritime sector and environment surrounding this, are huge.

1. Main drivers

One of the essential questions about those developments would be about the drivers. Now, this sounds now like the famous chicken and egg dilemma, but is there a clear answer to what have been the drivers behind this rapid innovation? Is it the technology, advancing quicker and quicker and the companies searching for more successful and sustainable solutions or has the overall background and development of the countries in the Baltic Sea region been the one creating more demand and therefore also the need for the service?

It certainly has been very different from country to country and during decades of political change and EU expansion.

From the point of view of a shipping entrepreneur, it has been the synergy of many, demand driven and proactive decisions, technological possibilities as well as the overall economic and geographical position in Europe.

When starting about the proactive approach, AS Tallink Grupp has definitely shown itself as the frontrunner of the industry on the Baltic Sea. The rapid renewal of the fleet with huge investments, acquisitions and testing out new markets, whether with direct routes or wide-scale international marketing are well-known for all who have followed the passenger ferry service sector.

2. Economic and political influence

Maritime industry, especially in passenger transportation, is a seasonal business, which makes it in general stronger in terms of ability to adapt to various changes in the overall conditions. The high season is traditionally the summer, due to the weather, making the cruising much more appealing to many. As the cruising products of regular lines usually also include the possibility to have a day-long visit to the destination city, the pleasant weather makes also this part of the trip potentially more enjoyable. And, one should not underestimate the importance of the destinations aside of the comforts and entertainment offered on board. Also the school holidays and larger national holidays are the peaks of passenger volumes in several months around the year. The companies do follow these traditional flows while shaping their activities and offers.

The cruising destinations around the Baltic Sea are rich in history and picturesque scenery, such as Swedish or Finnish Archipelago or islands like Gotland. It gives the cruising companies a far better chance to compete with other travel alternatives such as low cost airlines and city breaks just a couple of hours away.

In 2007-2008 when the economic recession hit the whole world, also the shipping industry was not left untouched. But, as said earlier, the positive habit of constantly adapting the business solutions to the changing seasons, made it easier also to adapt to the more complicated economic situation.

Actually, the passenger volumes did not decline, as the short distance travelling and cheaper vacation products on board including both transportation as well as accommodation, were now in focus for people in the region having less income, but the same desire to travel. After the more complicated times, more effort was again also put to the marketing and further markets were addressed. AS Tallink Grupp has directed more effective sales to many even exotic markets today, such as Asia. In July 2015, the fourth largest nationality on board of company's ships were Chinese.

The technological development and thorough synergy between information technology (IT), sales and marketing are definitely of great importance by reaching larger audiences, especially in distant markets. The online booking engines and mobile applications, enabling booking and purchasing tickets are nowadays an essential tool for passengers and companies. Around 70% of bookings of almost 9 million passengers AS Tallink Grupp transported in 2015 used the company's online booking engine for their transactions. At the same time the reliability, user-experience and variety in payment systems are to be secured.

The special status of the Åland Islands gives the cruising industry in the region an almost exclusive possibility not to be taken for granted in Europe – tax free retail. That has a huge positive impact on the region in general, as the operators have designed their routes to make use of this opportunity, offering the passengers an attractive shopping environment and enhancing so the overall tourism sector of the destination countries of the routes sailing through the islands, mainly to Finland, Sweden and Estonia.

3. High expectations

As much as people expect to have a good service and functioning IT-platforms for their transactions, they also are expecting comfortable and up to date ships. The exploitation time of the quality passenger ferries can reach easily 40 years, but in addition to the regular maintenance of the ships technical items, also the renewals of the interior are necessary, especially on the routes and vessels carrying up to 4.5 million people annually, such as AS Tallink Grupp does on Tallinn-Helsinki route.

The ferries of the Baltic Sea are fairly new and the older ones from the 1980s and the 1990s are very well maintained and renewed. In 2013 and 2014, AS Tallink Grupp invested € 40 million to renewing most of the interior Silja Serenade and Silja Symphony only. Every year, at least one of the vessels in the fleet of AS Tallink Grupp is getting a more or less thorough face-lift or service upgrade, also dependent on the consuming-related demand of the market. The competition is fierce and the passengers have fair, but high expectations to the on board facilities. The functionality and specific comfort details are important to follow every step of the way.

4. Solid know-how and craftsmanship

The ship operators in the region have also supported the development of the shipyards and related service providers in those countries by handing in orders regularly and in large quantities, enabling the utilisation, but also increase of the specific expertise. It is a great asset to have quality ship repair yards with good docking capabilities as well as yards building world class cruise ships just next door. It is a perfect example of how the different areas of one industry support each other and initiate or drive the growth, development and moving forward.

5. Technological innovations

The passenger ferries on the Baltic Sea are definitely among the most beautiful and well maintained ones in the world. They are also among the ones, who are following some of the strictest environmental restrictions and regulations for the technical operations and used fuel's quality.

The regulations, especially introduction to new ones has not always been the smoothest and has tested the industry's ability to adapt, invest and work very hard towards compliance. The lesson learned within the so-called Sulphur-Directive process from 2008-2015 was a painful one, but has hopefully strengthened the co-operation between authorities and ship-owners for future ambitious goals, which should be reached together. Goals like protecting the health of the Baltic Sea are by no means something any organisation would question about. The experience has shown that a tighter collaboration of scientists, authorities and practitioners from private and public sector are the essentials how to start climbing towards the goal without destroying other vital corner stones, such as economic sustainability. As for the long feared directive, 2015 proved that the ship-owners of the Baltic Sea are among the strongest and responsible ones stepping into the harshest (S)ECA in the world. The low fuel price has of course helped along to avoid the plunge into the new regulation dragging along a horrific price tag. At the same time, the process for the sake of environmental sustainability has been formed into progress in the field of maritime technology. The technologies, which target both environmental and economic sustainability by aiming to transform the quality and quantity of the consumption processes. AS Tallink Grupp is co-operating with organisations and scientists, offering ships as test grounds for new methodologies or substances, which might deliver even better results in the field of environmental sustainability. The companies in the region are used to deliver more than expected and as for the environmental concern of the Baltic Sea, the strict regulations in place have consequent in a rare result of the urge to deliver even more than required. On top, a whole sector has started developing in a higher pace, by inventing and testing new solutions for cleaner shipping.

6. Support is highly valued

Although the ship operators of the region have proven themselves to be successful, the support from local authorities and especially state level is essential. Finland, Sweden and Latvia have stated the importance of the sector in the maritime labour market legislation, which aside of the motivational aspect to continue there as an employer, also sets a powerful message about how these countries value the maritime industry. Unfortunately, Estonia has not followed the example of the neighbouring countries, but the hope remains. The cargo fleet has practically vanished from under Estonian flag by

now, the passenger fleet is mainly consisting of AS Tallink Grupp vessels and local route operators. The attractiveness of the registers is in direct correlation with the economic and legislative environment designed by countries themselves.

7. Traffic arrangements

The infrastructure and supporting organisations are well advanced and offer the operators as well as the passengers and cargo transportation quite good facilities.

From operator's point of view, there are two aspects to consider. The one for maintenance of everyday waste management, security management, energy supply and front- and back office facilities. There the quality and price are definitely are of importance, being still relatively different in ports around the Baltic Sea. As nowadays many regulations especially around the Baltic Sea are very strict, ordering operators to manage certain activities in a detailed way, the ability of infrastructure to support the operators is crucial. In many aspects we see the necessity to unify the standards for port facilities and services.

The other aspect is the comfort of the customers. Passengers expect modern and well-functioning units, short distances and extra service areas within the terminals, such as shops or catering facilities. Many ports around the Baltic Sea have or are in the way to update their premises accordingly and that are very good news for passenger shipping. Stockholm port with renewals in Värtahamnen, is the first one to deliver a modern terminal and gangway system. Helsinki and Tallinn will follow in the next years, following the environmental programme for the short cargo turnaround programme at the same time. Perhaps the parking and waiting areas are of concern everywhere, but this is the cost of having the ports practically in city centres.

8. Safety and security

The Schengen area and area of so called Nordic Agreement both ease the border crossing in an immense way, opening many additional options for transportation companies to arrange attractive time schedules and effective traffic management overall. For Tallinn-Helsinki fast ferry service the short boarding and loading times are crucial and good co-operation with the Customs and Border Guard on both shores secures the safety and security of the service.

The security has been a major question since the migration crises started and all stakeholders of the field have thoroughly re-examined their security plans and integration of those with each other. It is clear, that in order to provide maximum safety and security, the support and information flow from public sector organisations must be flawless and the instructions coming from there in time and clear. The joint exercises are therefore highly valued and appreciated.

Similar plans are also applied towards the health safety, where the companies have worked with Health Authorities to complete profound plans for fighting potential epidemics, including the latest ones of different influenza types.

It is also clear, that the ship operators can be very thorough with the precautionary measures and plans to act in different situations, but they never can replace the official organisations, whose purpose is to secure the areas of security and health safety. The document control, as well as other types of security control must be performed with utmost care from both sides, but the ones having the best expertise and resources for that are the local police and border guard. The ship operators fully rely on their know-how and support, when it comes to more complicated cases and so far the experience has been positive. In the light of the migration crises, the communication between the authorities and ship operators has become even more close, to prevent any kind of incidents.

Epilogue

The world is in constant change and all organisations have to be prepared to face rapidly changing conditions and situations. Also the shipping companies, who have been through large shifts in regulations and demands in latest decades. But, hopefully this has made us stronger to face both positive and negative changes the future brings.

Some words about AS Tallink Grupp: The predecessor of the leading passenger shipping company in the Northern region of the Baltic Sea was established in 1989, but has acquired the Finnish origin Silja Line brand in 2006, which roots reach back to 1957. The company has increased its passenger volumes from 160,000 people in 1990 to almost 9 million in 2015. The route network has been extended from one – Tallinn-Helsinki – to 6 altogether. The Tallinn-Helsinki route still continues to be the largest one for the company, being operated by 3 vessels, which transport over 4.5 million people annually. The tax free sales of the company have raised it among the largest travel retail companies in the world. Today, there are almost 7,000 employees working for AS Tallink Grupp in Estonia, Finland, Sweden, Latvia, Germany and Russia. In 2017, the company will introduce a new generation LNG-powered high speed ferry to the Tallinn-Helsinki route, bringing a new era to this very busy route.

Arctic shipping – Has it been put on Ice ?

Felix H. Tschudi

The Northern Sea Route (NSR):

- The NSR shortens the distance between the Atlantic and the Pacific by 40-60%, depending on the location of loading and discharging ports.
- The navigational season is from July to November with some fluctuations between years.
- The NSR stretches from Novaya Zemlya to the Bering Strait and is under Russian jurisdiction. Permission to pass is granted by the Northern Sea Route Administration in Moscow.
- Icebreaker escort by Rosatomflot is mandatory if required by the Russian authorities.

The Northern Sea Route significantly shortens the transit time between the North Atlantic and the North Pacific. This new route to the Asian markets has the potential to accelerate Arctic resource developments. To achieve this, knowledge of the route's existence, accessibility and significance needs to become more widespread among cargo owners, ship owners and industries that can benefit from its use.

Governments, resource companies and investors are looking north, as the potential for energy and resource development in the Arctic is beginning to materialise. Arctic shipping and transport solutions are key to their realisation. As this article will illustrate; there are few regions in the world where the logistical chains are more complex, capital intensive and critically important than in the Arctic. I will argue that the NSR is probably the single most important catalyst for the future development of the Arctic. I will therefore focus on the development of the NSR as the best indicator of future Arctic development.

In 2012, I was asked to write an article for the US Coast Guard's magazine Proceedings, discussing the significance of the Northern Sea Route. In it, I argued that the four most important factors for accelerating development in the Arctic region at the time were high commodity prices, ice reduction (climate change), technological advances and strong support from the Russian Government. My conclusion was that these factors together made investments in the region comparatively profitable despite the higher operating costs in the harsh and vulnerable Arctic environment. Four years later, it is time to revisit this statement and see what has transpired since it was written. Before that, however, I would like to describe the development over the past decade.

1. 2010: The Northern Sea Route (NSR) opens for international commercial shipping

In 2006, Tschudi Shipping Company bought the closed down iron ore mine, Sydvaranger in Kirkenes, Northern Norway. The mine's existing port infrastructure made it attractive for our company, which had long had an ambition of developing an Arctic port.

On the back of the booming commodity markets, the mine reopened and during the year 2010 all shipments went to China through the Suez Canal or via Cape of Good Hope. Against this background of an increasing number of shipments to China, the Northern Sea Route became a natural alternative with potentially significant savings.

In September 2010, the NSR Project 2010, a collaborative project among others involving the Centre for High North Logistics (see details of the project on www.chnl.no), resulted in a shipment of iron ore concentrate from Kirkenes to the port of Lianyungang, China. The voyage saved 5,700 nautical miles, which translated into a 17.5-days gain. The use of the NSR resulted in a 45% shorter voyage time compared to the Suez Canal. Russia has operated in the NSR for more than 75 years, and as such, the significance of the transit was not the passage itself, but the fact that it was carried out by a non-Russian vessel carrying a non-Russian cargo between two non-Russian ports. The NSR had proven itself as a commercial trade route open to all.

2. The NSR – increased use

In 2010, four vessels transited the NSR. Since then the number of transit voyages increased exponentially (although from a very low level) to 71 in 2013.

The most important take away from the more than 175 transit voyages over the past five years is the wide variety of vessels and cargoes which have used the NSR to their commercial benefit. The vessel types range from ice class tankers, bulk and LNG carriers, reefers, heavy lift and multipurpose vessels to international cruise vessels and offshore vessels repositioning between the Pacific and the Atlantic oceans (an example was a seismic vessel saving 8 days and significant charter hire mobilising to New Zealand from Hammerfest, Norway via the NSR rather than the Panama Canal).

During these years the shortest passage between Novaya Zemlya and the Bering Strait (the official Russian definition of the NSR) was recorded as 7.3 days set by a laden Sovcomflot tanker, at 162,000 dwt, the largest vessel to pass the NSR so far. As the availability of return cargoes are crucial for the long term viability of the NSR it was significant that some tankers and bulk carriers carried cargoes both ways, e.g. gas condensate from Russia to China and jet fuel in return from South Korea to Europe.

3. Commercial implications

In a 2012 report, Lloyd's, the London insurance market, predicted that as much as \$ 100 billion of investment would take place in the Arctic during the coming decade. The report predicted that the shorter transit to the resource-hungry markets of Asia via the NSR would benefit the developers of Arctic mining and offshore energy. The route turns a freight disadvantage into an advantage during the NSR season, which in turn makes these raw materials more competitive in the world market.

Our view was that the Arctic was holding potential for industries such as the shipbuilding and construction industries which would benefit from the increased demand for specialised ice class vessels and from the production of modules and structures serving offshore oil, gas and mining in the Arctic. This is presently happening with orders for a number of icebreakers and also the ordering of 15 icebreaking LNG carriers in addition to specialised module carriers and modules from Far Eastern yards for the Yamal LNG project. These vessels and cargoes will greatly increase the use of the NSR over the coming years.

4. Destinalional shipping

The prediction was that in the medium term destinalional shipping would be the main activity in the NSR. Destinalional shipping serves natural resource developments in the Arctic, including the ongoing traffic supplying northern Siberia, by employing specialised vessels such as ice breaking shuttle tankers, bulkers, multipurpose vessels and LNG carriers as well as purpose built offshore vessels transporting oil, gas, minerals, supplies and equipment in and out of the Arctic.

Siberian rivers offer other logistical possibilities for destinalional transportation via the rivers Ob, Yenisey and Lena to inner Siberia. This will over time benefit the local populations by facilitating regular exports of their local produce and making the imports of equipment and other production input factors less costly and more predictable.

As destinalional shipping employs very expensive purpose built vessels the use of transshipment hubs on the Atlantic and Pacific side of the NSR is necessary in order to secure their efficient utilisation. The NSR as a transit route may also require such transshipment hubs. In Norway, a Tschudi Shipping Company initiative, the Kirkenes Industrial and Logistics Area – KILA, a one million m² port area is planned as a western entry point to the NSR for transshipment, storage and industrial purposes. On the eastern side the United States, Japan, Korea, China and Russia all have their own designated Arctic ports. If these countries could agree on a joint eastern transshipment point, all would benefit. For example, Dutch Harbour or Adak on the geographically ideally placed Aleutian Islands could be great locations for such an eastern transit hub serving both sides of the Pacific.

5. What has happened since 2012, and how does it affect the Northern Sea Route ?

Until the peak season of 2013, the NSR experienced significant increase in numbers of voyages and volumes shipped. However, in 2014 the numbers fell sharply reconfirming the ever-valid jest: it's the economy, stupid.

The economic effect of the massive downturn in nearly all commodity markets, triggered and accentuated by China's industrial overcapacity, was and still is hitting the NSR. This has caused a fall in nearly all shipping markets (except tankers) resulting in sharply reduced savings from the use of the shorter route due to all time low freight rates and low bunker prices. Similarly, NSR suitable cargoes are lacking due to lower demand for commodities in general (e.g. iron ore and oil) and that the price differences between Asian and western markets (e.g. LNG) have disappeared.

Further compounding this negative trend, the time required for transiting the NSR has increased due to more unpredictable ice conditions over the past two years. At the same time, the waiting time to get icebreaker escort has gone up as Rosatomflot is presently busy serving energy-related projects, such as Yamal LNG. In the 2014 season additional uncertainty was added related to the interpretation and implementation of the 2013 law regulating merchant shipping on the Northern Sea Route. The bill introduces a single NSR Authority in order to simplify processing of transit applications, but has created some uncertainty among the relevant decision makers.

The close link between the general world economy and the use of the NSR makes it very difficult to assess the demand for NSR transits going forward. But one thing is certain: The moment money can be saved or made using the NSR the shipping operators and cargo owners will return!

At the time being, we see no direct link between the present sanctions on Russia and the decrease in NSR activity but of course the general political uncertainty may affect decision-making.

6. What happens now ?

Today, Rosatomflot's fleet of operational nuclear icebreakers consists of four vessels which will be phased out gradually over the coming 15 years. The renewal process has already started. Rosatomflot has ordered one icebreaker of the new LK-60 dual draft design, a 60 MW nuclear-powered icebreaker capable of breaking 2.8 meter of ice, the Arktika, to be built at the Baltic Shipyard, St. Petersburg for delivery in 2019. One more vessel of the same class, the Sibir, is scheduled to be delivered within two years of the first but both programmes are presently delayed due to budget constraints. Furthermore, a new class of icebreakers with a propulsion power of 110 MW capable of operating in ice up to 4.5 m is being planned.

Rosmorport, a Russian state company, is presently building the world's biggest diesel-engine icebreakers, the LK-25 (25 MW propulsion power). The first vessel named 'Viktor Chernomyrdin', is scheduled for delivery in 2017.

The renewal of the icebreaking capacity and the talked about strategic positioning of icebreakers along the full length of the NSR is preparing for regular and increasing traffic. On the negative side, it is evident that the Russian icebreakers since 2014 have primarily been engaged in Arctic oil and gas

BSR Policy Briefing 1/2016

projects and military assignments and it is likely that this priority will continue for some time. This weakens the position of the NSR as a predictable international transit route as the availability of sufficient icebreaker capacity must be seen as a necessary part of the NSR infrastructure and a condition for its efficient operation and regularity.

Not many shipping companies do yet have the experience of using the NSR. In order to bridge this experience gap, Tschudi Arctic Transit and Prominvest, a Russian/Swiss trading company, have established Arctic Bulk (www.arcticbulk.com) to promote and facilitate the use of the NSR by offering potential users advice.

7. Future development

Despite this negative development, the future use of the NSR will develop positively over the coming years as a result of the ongoing resource developments in Siberia not least the commissioning of the Yamal LNG project which will increase significantly the demand for transportation out of the NSR to the markets in the east and the west.

As reported by Dr. Bjørn Gunnarsson of the Centre of High North logistics in a recent article in Maritime Executive: *“the NSR cargo flow is expected to increase considerably with further development of Russian Arctic hydrocarbon projects. Year-round export of LNG from Sabetta Port should reach 17.6 million tons per year starting with the year 2021; crude oil from the Novoport Oil Field 8.5 million tons per year by 2017 (through loading terminal off Cape Kamenny); and crude oil from the Payakha Oil Field 7.3 million tons per year by 2024 (according to information from Rosatomflot)*

This is in addition to year-round transport of 1.3 million tons per year of nickel and other nonferrous metals from Norilsk Nickel at the Dudinka Port on the Yenisei River.

Other planned projects are Novatek’s Arctic LNG-2 on Yamal and Gydan with estimated 16.5 million tons of LNG produced per year; transport of 5-10 million tons of coal from the Taymyr Peninsula from the port of Dikson as part of the VOSTOK coal Project; and 45 million tons per year of crude oil as part of the Transneft-Arctic Project with development of an offshore loading terminal for crude oil in the Sabetta Port.”

And he continues: “In short, the NSR is the only throughway for Russian arctic resources and industrial products westwards to European markets and eastward to markets in NE Asian, and for promoting regional industrial development. Russia is the largest arctic nation with 70% of the arctic littoral, and is dependent on the NSR for its arctic development and will consequently work hard to promote it. One aspect of that should be Russia’s interest in facilitating access to Siberian ports for loading and discharging of non-Russian flagged vessels with the purpose to create round voyage possibilities through the NSR. Likewise, a major effort is needed to improve the NSR’s navigational and communication system as well as hydrographic data.”

8. But investments are needed

For the NSR to develop its potential as a major east-west transit route it has to be developed according to an overall plan as a complete maritime transportation and logistics system seamlessly linking infrastructure on its eastern and western sides with the required Siberian one.

If such a NSR master plan can be agreed upon the next step is according to Dr. Gunnarsson: *“estimating the costs of the various infrastructure components of the new system and establishing international cooperation and partnerships for putting the required infrastructure in place. Russia has already stated that ideal partners would be countries in NE Asia that see benefit in greater access to Russian Arctic resources and shorter trade route to NW Europe (China, South-Korea and Japan)”*.

Assessment of different funding mechanism in financing long-term capital-intensive maritime infrastructure within the Eurasian Arctic needs to take place. Joint funding among interested parties and governments must be investigated as Russia both geographically and financially cannot solve this alone. Initiatives such as the Silk Road Fund but also the recent initiative by the Global Agenda Council on the Arctic (a World Economic Forum initiative) investigating the possibility of establishing an Arctic Permanent Investment Vehicle guided by the Arctic Investment Protocol launched at the 2016 WEF in Davos may play a role (www3.weforum.org/docs/WEF_Arctic_Investment_Protocol.pdf).

9. Balancing economic and environmental needs

The increased activity in the Arctic with its new shipping opportunities represents new environmental challenges. A sustainable development model taking into account the environmental sensitivity of the Arctic must be implemented, aiming to make the environmental and economic developments mutually inclusive.

There is a window of opportunity now, before the development accelerates, for designing the ‘playing field’ in a way that balances these needs. For the sake of the development of the four million people living in the Arctic of whom around 400,000 are indigenous, economic development and environmental protection must not be allowed to be seen as mutually exclusive as so often before.

In this context, a number of environmental issues must be addressed and resolved. The development of the NSR is in its infancy and very cost sensitive at this stage. If too costly regulations are imposed at this stage the NSR will become uncompetitive and never develop to a sustainable level. An example of such a distorting measure would be a full scale ban on heavy fuel oil (HFO) in the Arctic while the alternative competing routes can continue to use this lower cost fuel. If the cost of such a ban should be warranted the negative effects of the use of HFO in cold climate relative to alternative lighter fuels must be proven beyond doubt. The implications of jumping to easy conclusions often based on myths could be very high for those living in the Arctic.

Likewise other environmental questions related to maritime activity in the Arctic should be addressed; which levels of black carbon and other emissions are acceptable before they pose a threat to the Arctic environment? Is shipping in the Arctic a significant source of such emissions and as it takes place mostly during the ice free season with open seas, i.e. with no or little ice, how significant is really the resulting

BSR Policy Briefing 1/2016

albedo effect? Other issues which need to be addressed are routing measures, speed reductions, designation of particularly sensitive areas, places of refuge and emergency response preparedness.

Today the development of a balanced regulatory framework is aided by the fact that the Arctic Council, the main driver of this process, consists of nations which all have direct interests in establishing sustainable solutions both economically and environmentally. An early positive result of this joint agenda is the Arctic Council's agreement on developing a framework for Search and Rescue and oil spill preparedness and response (the Agreement on Cooperation on Aeronautical and Maritime Search and Rescue in the Arctic and the Agreement on Cooperation on Marine Oil Pollution, Preparedness and Response in the Arctic)

In the longer term, the development of economic activity in the region is the best means to improve response capacity in general and emergency preparedness in particular. The more vessels in the area, such as ice classed offshore support vessels equipped with oil recovery equipment and other emergency features, the sooner assistance will be available in case of an emergency given proper cross border co-ordination.

For the time being, the best safety measure against accidents is Russia's regulatory requirements and the mandatory icebreaker escort by Rosatomflot. The plans for the establishment of land based emergency response facilities in the Russian zone of the NSR are positive, although more sea based response capability would be more effective.

10. What will it take to make the NSR live up to its potential and thereby open up the Arctic to regular shipping?

10.1. Cargoes

The most important driver is the availability of cargoes which require and can justify the extra cost of transportation through the Arctic to their markets. The availability of such cargoes is a function of the state of the commodity markets which today are very depressed. Despite that there are early signs of increased commercial focus on the NSR such as COSCO's 2015 announcement of a seasonal semi-liner operation offering to carry cargoes via the NSR.

The fact that Rosatomflot is refurbishing the nuclear ice breaking cargo ship 'Sevmorput' to carry containers (1,398-TEU capacity) along the NSR on an extended seasonal basis is further proof of this new focus. According to reports, the ship will in the period October-November 2016 conduct a two-way transit voyage between Murmansk and Petropavlovsk-Kamchatka in order to test its suitability for container shipping via the NSR.

When the upgrade is completed, the 'Sevmorput' could get a key role in the transportation of troops and military personnel to Russia's new and upgraded Arctic bases. The ship will also be used for transportation of goods to the new Pavlovsk lead and zinc mine in Novaya Zemlya, as well as for assignments for the Russian Arctic oil industry.

The addition of new powerful Arctic icebreakers to the national fleets of a number of nations, Russia, China and others, indicate the same increased focus.

10.2. Infrastructure

The NSR is now seasonally operational and open but requires additional infrastructure connecting it to the South in order for it to be recognised as an efficient and predictable commercial alternative to the three traditional routes.

Such initiatives can be the establishment of liner services connecting southern ports in the Atlantic and the Pacific to northern transshipment points but also the establishment of land based transport corridors connecting the Arctic to the southern continents. One such initiative is the Arctic Corridor (www.arcticcorridor.fi), a proposed transport corridor linking the Finnish city of Rovaniemi and the deep-water port of Kirkenes in the Barents Sea by a 580-kilometre railway connection. This would establish a direct land connection between the western end of the NSR and Europe. Such an initiative has the potential to create a unified economic North with its own industrial logic and momentum. The Arctic Railway would open for the fastest two-way transport of large volumes of raw materials, goods, oil and gas (LNG) between Europe, the Arctic and the North-Pacific region.

High North logistics is a chain which requires cross-border regional infrastructure solutions to work to its full potential. By such initiatives large transport disadvantages are turned into an advantage.

The Barents region but also the entire Arctic are regions “*Where gas meets ore*”. This can serve as basis for industrial processing of minerals and metals employing natural gas in situ to produce semi-processed higher value products for shipment directly to the markets in the west or via the NSR to the east. Such industrial activities will provide employment and development opportunities for the Arctic populations at the same time as the higher value end products become more economically robust and less vulnerable to market fluctuations. This could become a new industrial technological frontier which the Arctic nations, not least the Nordic countries, with their strong positions in metal, minerals and natural gas processing technologies can develop jointly.

11. Conclusion

Arctic development is dependent on Arctic logistics, which to a large extent will be sea-based. For Arctic shipping to be competitive the NSR must function both as a transport corridor out of the Arctic for Arctic resources but also as a viable alternative to the traditional global routes between East and West. This implies that Arctic development is closely correlated to the functioning of the NSR. The successful development of the NSR requires a holistic approach and co-operation across Arctic borders. This is not least true with regard to connecting north-south infrastructure which will act as a catalyst for Arctic development. The will to invest and develop such infrastructure will be crucial for the development of the Arctic. The incentive to realise such projects is mainly linked to the economic potential of the investments which is directly linked to the prices of the Arctic resources and the cost of transportation. This means that future Arctic developments and demand for Arctic shipping are closely correlated to commodity prices and freight rates which are presently under pressure. The next major wave of Arctic developments and shipping is therefore likely to take place when the prices of raw materials and freight rates again move up justifying investments in the necessary infrastructure and projects. Until then there will be a gradual development of existing projects at a steady pace, project by project.

BSR Policy Briefing 1/2016

The development of the Arctic in general and Arctic shipping in particular is a long-term challenge with long-term rewards – a bridge to the future for the North. It opens up for environmentally and economically sustainable developments, but to be realised it requires our political leaders' understanding, determination and courage!

In conclusion, we can say that the NSR and Arctic shipping is temporarily on ice but far from dead!

A useful source of information about logistics in the Arctic is the Centre for High North Logistics, (CHNL) with its Northern Sea Route Information Office based in Murmansk. CHNL acts as a knowledge network for sustainable logistics solutions in the Arctic (www.chnl.no).

Icepool – Holistic use of global icebreaker fleet

Tero Vauraste

Global icebreaker fleet consists of approximately 110 vessels and there are around 20 nations involved in these services around the Arctic and the Antarctic. The current fleet holds an estimated average age of 30 years.

There are significant fleet renewal programmes underway in all Arctic countries, which have icebreaker capacities. Russia has a programme of building more than 10 new vessels. The USA and Canada are working on their capacity renewals with one new icebreaker each. Finland has outlined, that the whole fleet of eight icebreakers will be renewed by 2029 and Sweden has announced a similar need of renewing their fleet of five vessels. Capacity needs exist also in many other countries with Arctic activities; these include China, France, Germany, Italy, Japan, Norway, South Korea and Spain.

Surprisingly and contradictory; most of the renewal work has so far been conducted on a stand-alone basis. International collaboration and a holistic approach has not been on top of the agenda.

Finland has been a forerunner in international collaboration within icebreaking services. There are three state-level collaboration agreements; one agreement between all Nordic countries and bilateral agreements with both Sweden and Russia. These agreements are aiming toward more efficient use of fleet mainly locally in sea areas within close proximity of each other. Similar type of practice is used in the Great Lakes areas where Canadian and US Coast Guards work together.

For Baltic Sea future needs, a Winmos-project, (Winter Navigation Motorways of the Seas) has been in progress for several years already. One of the objectives of this project is to assess possibilities of improved common fleet usage in the Baltic Sea.

Despite of these agreements and projects a more holistic view requires improved collaboration between the Arctic nations and also co-operation with Arctic nations and countries with research or other activity in the Arctic.

Only three or four icebreakers – out of a fleet of around 25 – operate outside of the Baltic Sea when they are not needed locally. That is the case mostly during summer periods of the Northern hemisphere, when there is no ice coverage on the Baltic Sea. The rest of the fleet just rests by the quayside. The current utilisation rate for these icebreakers is around 30-40% annually. That would be quite a poor cabin factor for an airline, would it not? Or how about making \$ 200 million investment and choosing whether you can utilise it for 3-4 months only instead of efficient use throughout the year? The answer is quite simple. Who would like to keep a car, an aircraft, or an industrial investment for 20 years longer with an argument of using taking advantage of the investment with a 30% utilisation. That is economically not viable. And nobody is doing that. Except some icebreakers.

Most of the remaining fleet capacity could be used in the Arctic areas for various purposes like supporting and conducting research, helping in Arctic Sealift, Search and Rescue likewise fairway icebreaking. Higher

BSR Policy Briefing 1/2016

utilisation means also less environmental burden. Shared use is already common thinking in many areas of service like car rental and car sharing likewise Airbnb for vacation and homesharing to name a few. It seems that private consumers and business to consumer service providers have been quicker in their service demands than the icebreaker service consumers and suppliers.

The main benefit of pooling and sharing is the distribution of depreciations, funding and other fixed costs among multiple users. With this model, cost per one client/user reduces as the utilisation increases. This model is very practical in Public Private Partnerships, where the costs are spread for a longer timespan and required capital is usually mostly provided by market economy driven organisations like private investors, banks and insurance companies. Time for Icebnb has come.

Let us make a rough and purely theoretical calculation based on holistic thinking. Let us assume that an asset value of one new 'average' icebreaker is \$ 200 million. 110 new vessels would then bring an asset value of \$ 22 billion. That is a theoretical investment value required for an instant global fleet renewal. What is required to successfully renew – and increase – the capacity? \$ 22 billion out of taxpayers' pockets is quite a lot – bearing in mind that there are only around 4 million inhabitants in the Arctic area. It would be more than \$ 5,000 per inhabitant. That would not work. How to spread the costs geographically and for a longer timespan? Public-Private Partnership provides opportunities by bringing in investors from other areas and leveraging the investment for a longer period of time.

Another element of helping the improvement of utilisation lies on advanced weather forecasting. Weather reporting and predicting play a very significant role in planning the icebreaker operations. Long-term forecasting (decades) helps the industry to develop vessels suitable operating throughout their lifespan of 25-50 years. Annual prediction helps the operators in allocating their resources. Daily to weekly forecasts support the daily planning.

How about trying really to research the east-west winter patterns? During the two most recent winters the North American Great Lakes areas have suffered from severe conditions and simultaneously, the conditions in Northern Europe and the Baltic Sea have been exceptionally mild. Should we learn to forecast this, we could provide the icebreaker operators even more improved chances of supporting their customers on the other side of the globe. If we knew, that a mild winter is expected to take place in the Baltic Sea area, we could send even more resources to other areas like North America. That would also enhance an improved co-operation in the areas of the Northern Sea Route, where despite current icebreaker resources additional capacities would be welcomed from time to time.

A purely commercial model for icebreaker services exists only in some areas of operation. Services based on a fee are provided in the Great Lakes areas, the Northern Sea Route and the Baltic Sea. In North American sea areas this type of approach has not been seen yet. Ice management provides an exemption of this, where the customers are mainly energy companies.

In conclusion, a holistic Icebnb approach could be developed by taking advantage of the current long idle periods, improved weather forecasting and creating commercial value chains based on the requirements of the shipping companies to reduce their costs whilst choosing the Polar routes instead of Panama and Suez.

Shipbuilding industry in the Baltic Sea region

Kaidi Nõmmela and Alari Purju

Executive summary

The shipbuilding industry went through major structural changes in all the Baltic Sea region countries during last thirty years. Total volumes of production diminished substantially but specialisation made possible to maintain some high value sub-areas of production as cruise ships or specialised vessels to serve offshore industry. Denmark and Sweden practically closed down their shipbuilding industry. The shipbuilding capacity decreased substantially in Germany, but consolidation and diversification of production renovated the shipbuilding industry. Norway and Finland continued as competitive producers in specific subsectors, such as cruise ships, offshore vessels and icebreakers. Poland restructured its industry on much lower level of production capacity and has some competitive companies. The Baltic States continued with existing companies, some consolidation took place and some small and medium-sized companies were successful in certain niches as workboats. Russia aims to diversify the legacy of the military shipbuilding and increasingly engage in the building of civil vessels. Sanctions imposed on Russia resulted in a ban on further supplies of modern marine and shipbuilding technologies to Russia. The co-operation between companies with different technical skills and cost structure, combining specific shipbuilding competences with competences of companies providing innovative engineering services is one comparative advantage of the Baltic Sea region.

1. Introduction

The shipbuilding industry was an important area of business in the Baltic Sea region up to the 1970s. The big crisis in the 1970s initially diminished and afterwards almost phased out the industry in Sweden and Denmark. Shipbuilding in other Nordic countries and Germany adjusted itself to new conditions in different ways. Though the shipbuilding capacity decreased substantially in Germany in the 1980s and the 1990s, consolidation and diversification of production renovated the shipbuilding industry and Germany is still the largest shipbuilding country in Europe. Orders of naval sector had also a role in success of Germany's shipbuilding. The country has the new strategy to significantly increase the volume of German shipbuilding. In Norway, specialisation in offshore vessels, small special and recreational vessels played important role in restructuring of the shipbuilding industry. Important factor has also been the demand of Norwegian shipping companies for new vessels constructed in Norway. Finland's shipbuilding industry went through major organisational changes and specialised in construction of cruise vessels and icebreakers. One specific feature of shipbuilding industry in Nordic countries is that it includes also a wide variety of equipment suppliers, many of which focus on special technologies and provide products and services for demanding conditions.

Shipbuilding in Poland and the Baltic States had significant changes, too. Poland was an important European level shipbuilding country before the 1990s and a deep decline and consolidation of companies took place afterwards. Nowadays, Poland still has quite competitive shipbuilding industry, which at the same time faces very strong competition from Asian shipyards, in the first place. Estonia

has the largest shipbuilding company in the Baltic States, which has also purchased and is introducing subsidiaries in the other Baltic States. Beside some large companies, a set of small and medium-sized specialised companies in the shipbuilding sector has also emerged in the Baltic States.

Russian shipbuilding industry also went through major changes and after deep decline in the 1990s, the state managed consolidation started in the 2000s. Russia invested heavily into its ports' capacity, especially in the Baltic Sea area. The need to serve oil exports and fields located in sea area and the potential of the Arctic Ocean route are important demand side factors for the shipbuilding industry. Modernisation of technological base of this industry is an important pre-condition of development. Military shipbuilding holds important position in this industry.

One specific phenomenon of the Baltic Sea region is that quite a strong shipbuilding cluster has arisen here with strong connections between main companies producing final products and a wide set of subcontractors, who perform rather specialised operations. This specialisation and co-operation between companies from different Baltic Sea region countries is one potential factor of success of the shipbuilding industry of the region in global competition.

2. Germany

Germany is the largest shipbuilding nation in Europe and has at present around 130 shipyards; more specifically 60 shipyards, when dismissing the small ones (CESA 2013). However, German shipbuilding has faced significant changes, as since 1975 German shipbuilding capacity has been reduced by 75% in the large shipyards and 40% in the smaller ones (Global Security 2016a). Also the structure of German shipbuilding has changed from producing container vessels (2/3 of production in 2004) towards more specialised vessels, such as cruise ships, passenger vessels and yachts. Quite a few shipyards have been subject to insolvency and consolidation following the crisis in shipbuilding in 2008 and 2009, and further consolidation and bankruptcies have been predicted. An example of the consolidation is ThyssenKrupp Marine Systems GmbH, which acquired several shipyards, e.g. HowaldtswerkeDeutsche Werft and Blohm+Voss. However, in 2009 they decided to quit the container market and sell off production sites, such as Nordseewerke to SIAG. The amount of foreign ownership has also increased among the German shipyards as companies from Russia, Great Britain and the Persian Gulf have purchased shipyards (VDR 2016).

The shipping industry in Germany is substantial, especially the container vessel segment. The development of the German merchant navy fleet from 1970 to today demonstrates a steady growth. At the same time, however, the number of vessels under the German flag has decreased from 100% to 15% (VDR 2016). Before 2008, the industry boomed partly thanks to the financial structure that enables the shipping companies to sell and charter back their vessels to a special purpose company, which sells the equity further to private investors, who get tax benefits. This enabled a continuous renewal of the fleet (Marine Money Offshore 2013). However, the German shipping companies too have faced difficulties after 2008 due to the financial crisis, overcapacity of vessels and declining freight rates. Financing has become harder to come by and German shipping financiers such as Commerzbank have withdrawn from shipping altogether. Private investors, banks and ship owners are encouraged to come up with solutions and financing concepts, as the means of the state to finance novel buildings are limited and mainly consist of export credit guarantees and innovation support. The rising costs and decreasing

incomes cause further pressure towards merging especially of small and middle-sized shipping companies.

The amount of employees in shipbuilding has grown again after the slump in 2008-2011. In total, the order book for the German shipyards was, according to its worth € 8.5 billion in 2013, showing an increase from the previous year and consisting up to 80% of passenger vessels and yachts (VDR 2016). However, diversification has been a success factor, as the German shipyards still build a variety of ship types and also do substantial repair work. The naval sector is an important customer segment for the German shipyards which construct, for instance submarines for exports. Around one fourth of the shipbuilding turnover comes from the naval sector. Other segments growing in importance are offshore and wind power (VDR 2016).

Papenburg-based Meyer Werft appears to be the success story among the German shipyards. Meyer Werft was founded in 1795 and is in its sixth generation of family ownership, as Bernard Meyer is the managing partner of the company. Meyer Werft builds cruise vessels, passenger ferries, as well as gas tankers. River cruise vessels are being constructed at Neptun Werft, a subsidiary of Meyer. Meyer contributes to up to 70% of the total shipbuilding in Germany and has demonstrated a steady order intake during the past years, which have been difficult years for shipbuilding (Meyer Werft 2016). Meyer Werft, as well as its subcontractor network, has benefitted from using Porsche consultants in order to improve its processes. Also, Flensburg shipyard has worked with Porsche. Other examples of successful family-owned shipyards or shipyard groups are Abeking & Rasmussen and Lürssen, who has expanded strongly and is a leader in mega-yachts (VDR 2016).

There are around 380 ship owners in Germany, of which the majority are small with less than 10 ships (VDR 2016). The largest companies in terms of owned tonnage are Claus-Peter Offen Reederei with 85 ships with a gross tonnage of 5.5 million, followed by ER Schiffahrt GmbH & Cie KG with 100 vessels but smaller in terms of tonnage, and Peter Doehle Schiffahrts-KG with 119 vessels. In terms of operated tonnage, Oldendorff Carriers GmbH & Co comes in the sixth place worldwide with 494 operated vessels, followed by Hapag-Lloyd AG, who operates 148 vessels (Danish Shipping Statistics 2015).

2.1. Competitive situation

Marine technology is seen as an area where German companies possess a vast knowhow and where growth is expected. In 2011, the government decided on a National Masterplan for Maritime Technologies (NMMT), in order to strengthen the position of German companies on the world market and pool efforts of companies and research organisations in the area. According to German data, total shipbuilding and on-board equipment revenue was € 18 billion in 2014 with the annual volume of production being 1.4 million gross tonnes. The revenue is planned to increase up to € 23 billion in 2018. The plan focuses on maritime technology in the fields of offshore oil and gas, offshore wind energy, underwater engineering, maritime traffic control and security technology, and marine mineral raw materials. The fields of action include strengthening R&D and improving co-ordination between research programmes, promoting exports through political support, establishing networks, expanding educational programmes and developing demonstration and beacon projects, such as smart systems in maritime engineering (Gerden 2015). The implementation of the new strategy is expected to allow German shipyards to more effectively compete with shipyards of other countries. The German Government plans also to provide significant assistance to domestic shipbuilders in the framework of

EU rules of state aid. The strategy also involves expansion of export markets, especially more intensive presence in the markets of emerging nations, particularly China, India and Russia (Marine Link 2016).

3. Norway

The Norwegian maritime cluster took the financial crisis well, largely due to the diverse range of vessels constructed in the country, which has helped the businesses to adjust to the market fluctuations, with the efficient networks within the cluster being a key source to success. In addition, while the global overcapacity in shipbuilding keeps the prices low, Norwegian shipping companies aim at strengthening their future positions by ordering new ships (Henriksson & Huhtinen 2013). The sector's future prospects are positive – not only because of the good conditions of the cluster, but also due to the emerging opportunities regarding Arctic shipping routes and offshore subsea energy production. Particularly the Norwegian offshore industry is under extensive development, illustrated for instance by the fact that it is the second largest in the world after the USA (Reve 2009; Henriksson & Huhtinen 2013). Norwegian offshore fleet comprised some 522 ships, 42% of which sailed under the Norwegian flag at the beginning of 2015. A look at the composition of the fleet shows that offshore service vessels made up the largest segment by number of ships and this is the only segment with the significant number of ships registered in Norwegian Ordinary Ship Register (NOR) (Maritime Outlook 2015).

Norwegian international shipowners had a total of 176 ships on order as of 1 January 2015. Of 176 ships on order, 119 are no offshore service vessels. The order book had a combined value of \$ 12 billion. Approximately 15% of current orders have been placed within Norwegian yards, seen in number of ships. Offshore service shipping companies are responsible for around 80% of all activity of Norwegian shipyards and offshore vessels represent 30% of the Norwegian order book (Maritime Outlook 2015). Substantial investments are directed into the related technology development, research and education in order to ensure adequate resources to meet the needs of this globally growing sector (Driftsrapport 2012; Maritime Outlook 2015).

Altogether, there are 75 yards in Norway, focusing mainly on construction, repair and maintenance work on a wide variety of specialised ships such as offshore vessels, advanced fishing vessels, passenger/car ferries and specialised coastal vessels (Maritime Outlook 2015). Around 25 yards focus on construction of new vessels, with the largest concentrating on offshore and special vessels such as LNG ships and specialised tankers, and smaller yards focussing on fishing boats and other small vessels (Henriksson & Huhtinen 2013; Maritime Outlook 2015). The currently largest shipyard groups are STX OSV (Aker Yards), Bergen Group and HavYard Group, which have all been established during the past 10 years (Henriksson & Huhtinen 2013; Maritime Outlook 2015). Ship design is also an important area of business, even though it nowadays is mostly carried out in foreign-owned international companies, such as Wärtsilä Ship Design, Rolls-Royce Marine and STX Norway Offshore Design (Jakobsen 2010). The industry also includes a wide variety of equipment suppliers, many of which focus on special technologies and provide products and services for demanding conditions not only in offshore but also in fishing sector (Jakobsen 2010).

While the Norwegian maritime cluster develops and produces innovative technologies and specialised products, foreign companies have also found it beneficial to set up operations into the country. For instance, Rolls-Royce is a significant operator in the Norwegian market, employing around 3,000 workers in the country (Rolls-Royce 2013). As another example, Fiskerstrand BLRT AS, a Norwegian

subsidiary of SC Western Shipyard (part of the Estonian-based BLRT Grupp), specialises in designing and building small to medium-sized car and passenger ferries. The company's future aim is to focus on renewable energy, particularly on supplying vessels and products related to offshore wind farms. (Fiskerstrand BLRT 2016; Western Shipyard 2016) At the same time, Norwegian companies are very active in international markets and co-operation activities. For instance, due to the rising labour costs, it is becoming more common in shipbuilding that parts of a vessel are constructed abroad (in the Baltic States for example) and the final assembly takes place in Norway. Norwegian companies are also exemplary in successful international business networking and marketing of their own expertise, and have gained strong presence in the key future markets, such as Brazil, Western Africa and Australia, related to the offshore sector particularly (Henriksson & Huhtinen 2013). A lot of this success stems from beneficial and proactive state actions. As an example, Norway signed a free trade agreement with South Korea as early as in 2006, and Norwegian companies actively took advantage of the provided opportunities. The EU signed such an agreement only in 2011.

While the Norwegian maritime sector already includes a large number of global actors operating in areas such as specialised shipbuilding, offshore, fishing and seafood, all these actors create a relatively well networked hub of expertise (Reve 2009). In fact, a global knowledge hub is what Norway is consciously building around the maritime activities with triple helix level support. The state, local universities and the industry are closely co-operating and supporting each other through this approach, which is continuously being developed. Various associations also play a strong role in the Norwegian maritime sector. An influential example is Maritimt Forum, the head organisation for all the labour and employee organisations covering the whole value chain of shipping (Maritimt Forum 2016). Creating a co-operative environment between different actors relevant in the sector's development is considered crucial in a country with high production costs in order to maintain global competitiveness (Maritime Outlook 2015).

3.1. Competitive situation

The Norwegian maritime cluster benefits from unique expertise in maritime sector, largely due to the long tradition in developing the related technologies and knowhow. Norwegian shipping companies are important customers for the shipbuilding sector, but especially of offshore vessels (Maritime Outlook 2015). However, as the salary costs in Norway keep rising along with the levels in the oil and gas industry, the cost levels of Norwegian shipbuilding have become a troublesome issue and a key challenge to the sector's competitiveness in the country (Laaksonen & Mäkinen 2013; Maritime Outlook 2015). One example of a Norwegian vessel order not built in Norway is the latest addition to the Norwegian Cruise Line fleet, which was created by British SMC Design together with Swedish Tillberg Design and built by Meyer Werft in Germany (Cruise Business Online 2013). It has been acknowledged years ago that the Norwegian maritime industry is not competitive in terms of building large vessels, and the focus has been shifted to more specialised vessels. However, another interesting case was Statoil ordering a Dagny-rig from South Korea, which aroused a lot of media discussion as it was the fifth consecutive large-scale investment that Norwegian shipyards, despite excellent expertise, lost abroad. When orders are lost and activities do not continue right after another, it is even more difficult to improve local knowhow and competitiveness. As a result, some of the least profitable shipyards have been closed (Henriksson & Huhtinen 2013).

To support the sector's competitiveness through continuous production of cutting-edge knowhow and skilled workforce, Norwegian universities are closely involved in the maritime sector's development. For instance, specific professorships have been introduced and sponsored by the industry to promote research related to the maritime sector. For example in Trondheim, considered the technological capital of Norway, there is the Marintek research and development organisation with advanced test facilities. Their testing laboratory, opened in 1981, is the largest in the world and the advanced technology attracts customers from all around the world (Wärtsilä) to do various maritime product-related tests. At the same time, the cluster's advancement is supported by wide business and co-operation networks around the world. For instance, Singapore has major financial resources and substantial initiatives, but is missing human resources and is hence interested in the education and knowledge provided in Norway (Jakobsen 2010).

4. Finland

The Finnish shipbuilding competence is on a high level due to long and extensive experience, fostered by the war payments to the Soviet Union after World War II, which forced Finland through a rapid industrialisation process. Through consolidation and increased specialisation during and after this time period, the previously small Finnish shipbuilders became relevant actors on the international market. However, the Finnish shipyards have been suffering from poor profitability and changes in ownership. After the bankruptcy of Wärtsilä Meriteollisuus Oy in 1989, Masa-Yards was formed. In the mid-1990s, Norwegian Kvaerner purchased Masa-Yards and Kvaerner Masa-Yards was born. In 1991, the shipbuilding businesses of Hollming Oy of Rauma and Rauma-Repola of Rauma on the west-coast of Finland were merged to form Finnyards. This company was later purchased by Aker and became Aker Finnyards. In January 2005, Kvaerner Masa-Yards and Aker Finnyards merged and formed what was called the 'new' Aker Finnyards Oy. Since 2008, Korean STX owned these Finnish shipyards. STX Europe AS, a subsidiary of the South Korean STX Corporation, is the largest shipbuilding group in Europe and the fourth largest in the world. They operated 15 shipyards in Brazil, Finland, France, Norway, Romania and Vietnam (STX Europe 2012). In 2014, Meyer Werft purchased the Turku Shipyard from STX and Meyer Turku Oy was created. Meyer Turku Oy specialises in building cruise ships, car-passenger ferries and special vessels. Together with two sister shipyards in Germany, Meyers Werft in Papenburg and Neptun Werft in Rostock, Meyer Turku Oy is one of the world's leading cruise ship builders (Meyer Turku 2016). The company has also subsidiaries, which provide necessary final solutions and services. Piikkio Works Oy is a cabin factory in Piikkiö, Shipbuilding Completion Oy provides turnkey solutions to public spaces in ships and ENG'nD Oy is an engineering company offering services for shipbuilding and offshore activities (Meyer Turku 2016).

Turku shipyard has been a technically advanced company. They constructed a passenger ferry for Viking Line, which uses LNG as fuel. They also started construction of a similar ship for Estonian Tallink company in 2015. They constructed, among other things, a small offshore installation vessel for Meriaura, with special features, such as dynamic positioning, and it is the first double acting dry cargo ship (DASTM) in the Baltic Sea. The vessel can also be used for preventing oil pollution, with large tanks that, when in use will double the Finnish oil pollution prevention capacity (Meriaura 2016). Moreover, the vessel uses bio-oil as fuel.

The Helsinki shipyard was some years ago facing the grim perspective of being closed down as it was deemed too small for constructing cruise vessels, and considering the market situation at the time three

shipyards were too many. However, the Russian OSK came to its rescue, and it is now called Arctech Helsinki Shipyard Oy and was then owned 50% by STX and 50% by the Russian OSK. In December 2014, the Russian company acquired full ownership of the Arctech Helsinki Shipyard Oy. The shipyard specialises in Arctic shipbuilding technology, e.g. building icebreakers and other Arctic offshore and special vessels. As the Helsinki shipyard has constructed 60% of all icebreakers operational today worldwide, and Russia needs to renew its icebreaker fleet, while simultaneously investing in its shipyards and shipbuilding competence, the co-operation gives the Russian corporation a good opportunity for learning; i.e. so called technology transfer. At present, the co-operation model is such that hulls are constructed in Russia (e.g. Kaliningrad or Vyborg shipyard) and taken to Helsinki for outfitting (Laaksonen & Mäkinen 2013).

In addition to the Meyer Turku Oy shipyards, there is the Turku Repair Yard, which is owned by Estonian BLRT. The shipyard carries out different types of repair work, refurbishing, conversions (Turku Repair Yard 2012). There is also a shipyard in Pori, owned by French Technip, which is specialised in offshore contracts, such as Spar hull and mooring systems, drilling rig conversions, offshore construction services and heavy industrial products. The shipyard has recently acquired new orders (Technip 2016).

Finnish shipyards have provided vessels for ship-owners around the world, for example the world class cruise vessels operating in the world seas. Besides cruise ships, Finnish shipbuilding is specialised in passenger ferries, icebreakers and military ships (Hernesniemi 2012).

4.1. Competitive situation

Finnish shipyards' main competitive advantage lies in a high degree of specialisation and innovation, as well as fast delivery times and reliability in keeping those. The competitiveness of the Finnish shipbuilding cluster is highly dependent on the vessel type. For standard vessels, competitiveness is on a low level because the production process is aimed at specialised vessels, as the strategic choice has been made to focus on these instead of on standard cargo vessels. This means that the Finnish shipyards have a different cost structure than the large Asian (mainly Korean and Chinese) shipyards, which are specialised in serial production of standard vessels.

The competitiveness of Finnish shipyards regarding highly specialised vessels, e.g. cruise and passenger vessels involving much design work is higher, as these require a high level of expertise and innovation, which means that competition is scarcer. On the other hand, these kinds of vessels are more seldom produced in series of more than two or three. The so-called one-offs are very expensive to design and construct and as a rule, the profits from shipbuilding come from constructing series of vessels, where most profit is made after the first few vessels. The margins made by the Finnish shipyards are quite small, and therefore shipbuilding is not a highly profitable business (Maritime Cluster Analysis 2012).

Finnish shipbuilding is especially strong in hydrodynamics and conceptual development, for example in the area of energy saving which is becoming increasingly important for ship owners. Project management skills can also be considered high. As an example, the Finnish shipyards have, by applying concurrent engineering managed to shorten lead times significantly. The trend has for many years been towards increasing outsourcing; of design to design companies as well as manufacturing of larger areas (cabins, public spaces, HVAC et cetera) to the so-called turnkey suppliers. Conceptual and basic design is kept in-house. However, it has been questioned whether this development has gone too far and the

shipyard should regain control of some of the outsourced areas, such as piping or other technical installation behind interior linings.

In terms of operational effectiveness, some investments in increasing productivity have been made. The shipyards have, for example invested in 3D design; for example the passenger ferry being constructed for Viking Line is fully designed in 3D. However, the changes in ownership and management of the Finnish shipyards are considered as a drawback, which has resulted in a lack of long-term thinking and has influenced investments negatively (Maritime Cluster Analysis 2012). The acquisition of Turku Shipyard by Meyers Werft in 2014 created new opportunities and brought in new orders for the company. Meyer's advantage lies in its family ownership, which has ensured a long-term commitment to invest in production improvements, as well as in securing a functioning partner network, whereas in Finland the co-operation with the network has at times been strained due to cost pressure (Meyer Werft 2016).

Although the EU has banned direct subsidisation, there has been a large amount of support aimed towards the industry through government actions, such as export guarantees, innovation support and supporting R&D through large research programmes involving companies from the whole cluster. Shipbuilding has high prestige and is regarded as nationally important in Finland as it has a major impact on employment (20,000 people are directly or indirectly employed by shipbuilding). There is still plenty of competent personnel to be found in Finland, although there is a worry that the younger generation is not as interested to study the subject of shipbuilding (Maritime Cluster Analysis 2012).

There continues to be a demand (although not that large by numbers) for cruise vessels and ferries as the number of people choosing a cruise for their vacation is increasing globally. The cruise market is characterised by the need to bring in new vessels with new features on a regular basis in order to attract new and repeat customers. Moreover, the ferry fleet in Europe is aging and is in need of renewal. New segments, such as offshore and renewable energy, are also in a need of vessels with a high degree of innovation. Simultaneously, the competition is fierce as there is plenty of free capacity in the shipyards globally. This leads to pressed prices which Finnish shipyards have a hard time to compete. The customers are rarely local, except for Viking Line and Meriaura, who have ordered vessels from the Turku shipyard.

The main challenge lies in staying competitive in order to secure future orders. This means keeping control on costs but also investing in further developing facilities, competences and ways of working to ensure maximal efficiency and a high degree of innovation. Modularisation is one area that has been developed in order to enable mass customisation and further decrease lead times; material technology is another very important area to e.g. reduce ship weight, improve safety etc. As energy prices have increased rapidly, a main focus area has already for some time been energy efficiency. Any innovations that save money for the customer in operations phase form a major opportunity for the innovator. Fuel technology is a major opportunity as the environmental regulations by IMO are becoming stricter and place a demand for new fuel types and machine technology solutions (IMO 2008). The sulphur oxide (SO_x) and nitrogen oxide (NO_x) regulations are getting more exacting, which means for example that in the long term new fuel types need to be found to replace heavy fuel oil, especially in the ECA areas (Emission Control Areas). These developments provide an opportunity for the shipyard to come up with designs for vessels that meet the new criteria. To meet these needs and capitalise on the opportunities, the shipyards would need to focus on further improving the way of working with their subcontractors,

to ensure a sufficient amount of long-term product development through joint R&D projects and co-creation between current projects.

The offshore segment provides an opportunity for the shipyards, for example as subcontractors to Norwegian contractors. There are also opportunities to increase the life-cycle activities of the shipyards as this area has a lot of underused potential. For example, the more stringent environmental regulations provide opportunities regarding retrofits, conversions (Maritime Cluster Analysis 2012).

5. Sweden

Swedish shipbuilding industry belonged to the largest in world up to the 1970s. After the year 2000, Sweden has been the only Nordic country that has practically shut down the shipbuilding industry and today the Swedish shipbuilding is mostly a cultural and historical heritage (Maritime Cluster Analysis 2012).

The only larger shipbuilding company still functioning is the ThyssenKrupp-owned Kockums. Kockums is focused on building submarines and naval surface ships, specialised in naval and stealth technology (Kockums 2012). Another actor with a long history is the yard Götaverket Cityvarvet AB, where operations were restarted in 1993. Since then the amount of 70 employees has doubled, and in 2000 it was acquired by the Dutch company Damen Shipyards Group. With the specialisation in repair work and the location in Gothenburg, the Götaverket Cityvarvet AB has reached a stable position on the market (Damen 2016).

Damen Shipyard Group acquired another Swedish company in May 2012, the repair and maintenance yard Oskarshamnsvarvet, which has operated since 1863 (Damen 2016). Beside these companies, a number of smaller shipyard companies are operating in Sweden, focusing mainly on repair work.

The association for Swedish yards has 25 members which employ the total of 1,200 people and have a total turnover of SEK 1,300 million (€ 140 million) in 2010 (Maritime Cluster Analysis 2012). There are, in other words, still some actors present and active, but they are single yard companies here and there. There is no longer a considerable shipbuilding industry in Sweden and no sign that this will change in the near future. The Swedish presence in the marine industry in terms of shipbuilding is not significant in a larger perspective.

6. Denmark

The shipbuilding industry in Denmark has followed the Swedish example and has almost been phased out. The remaining shipyards have been converted into repair yards, such as Fayard shipyard in Odense and Hirtshals Yard, which was started after Wärtsilä closed its office there (Maritime Cluster Analysis 2012).

There are also some strong marine industry suppliers in Denmark. Burmeister & Wain was a former Danish shipyard and a leading Danish engine producer, until it was acquired by MAN in the 1980s. However, it still maintains some activities in Denmark under the MAN brand. Other strong competence

areas are found e.g. in lubrication oil and boilers, through Aalborg industries which is today part of Alfa Laval (Maritime Cluster Analysis 2012).

7. Poland

Poland has been one of the largest shipbuilders in Europe, as well as successfully competing with the Asian shipyards. In 2000, Poland held the fourth place, after South Korea, Japan and China, in the world ranking of shipbuilding, with 5.7% of world orders on trading vessels. Shipbuilding, including ship repairs, has been playing a significant role in the Polish economy (Global Security 2016b).

Polish shipbuilding and ship-repair industry includes Stocznia Gdańsk (Gdańsk Shipyard), Morska Stocznia Remontowa Gryfia (MSR Gryfia), Gdansk Shiprepair Yard Remontowa and Nauta Shiprepair Yard. In 2012, the Polish ship repair yards had about € 350 million of total turnover and 15,000 employees (Aszyk 2013).

In 2008 and 2009, the Polish shipbuilding industry faced one of the major challenges in its history resulting in major changes in the sector. In 2008, the European Commission concluded that state aid granted to Gdynia shipyard and Szczecin shipyard had given rise to disproportionate distortions of competition within the Single Market, in breach of EC Treaty state aid rules, and must be repaid (Global Security 2016b). The production in Szczecin Shipyard was suspended in January 2009 – the European Commission decided that help the Polish Government granted the Szczecin and Gdynia shipyards was against the law. The shipyard assets were sold and the employees fired (Euro infrastructure 2016). The Polish shipbuilding industry collapsed, with employment declining from 11,000 in the Gdansk, Szczecin and Gdynia yards in May 2009 to about a half in the following year.

Stocznia Gdańsk (Gdańsk Shipyard) is a globally recognised shipbuilder with experience more than 65 years. In 2006, the Gdańsk Shipyard was formally separated from the Gdynia Shipyard Group and was renamed Stocznia Gdańsk SA. Since 2008, the main shareholder of Stocznia Gdańsk has been the Gdańsk Shipyard Group owned by the Ukrainian industrialist Serhiy Taruta. 25% of the company's stock is held by the Industrial Development Agency of the State Treasury. Today, the Shipyard operates a group of companies for which the parent undertaking is the Gdańsk Shipyard Group. Since the beginning of 2015, the group has been increasing its headcount, has a portfolio of orders and has been generating better financial results (Gdansk Shipyard 2016).

MSR Gryfia was created as a result of the merger of two West Pomeranian plants, which have operated as one company since September of 2013. The Yard is in possession of production plants, in Szczecin and Świnoujście, respectively. The Yard offers services in terms of repairs, rebuilding and new builds. Also, damage repairs and class inspection of ships are carried out. MSR Gryfia has at its disposal a total of six floating docks in Szczecin and Świnoujście, including one of Poland's newest and largest docks with deadweight of 17,000 tonnes, which allows dry-docking ships with up to 40,000 DWT (MSR Gryfia S.A. 2016).

Gdansk Shiprepair Yard Remontowa belongs to Remontowa Holding capital group, which specialises in ship conversions and repairs, designs and constructions of new ships, offshore units and steel structures. Presently, the Remontowa S.A. is the largest repair and conversion yard in Poland. Every

year, over 200 vessels from all over the world are repaired or converted at this yard (Remontowa 2016). In 2012, the company had 1,500 own and 2,000 outsourced employees (Aszyk 2013).

Nauta Shiprepair Yard located in Gdynia is one of the oldest yards in Poland. Nauta Shiprepair Yard offers service in ship repair and conversion field, also in special projects and new buildings. The Yard has experience in designing and building different offshore and research vessels, firefighting and rescue vessels, tugboats, barges et cetera. In 2012, Nauta Shiprepair Yard transferred most of its facilities to the Gdynia Shipyard's previous area (Nauta Shiprepair Yard 2016).

7.1. Competitive situation

After difficult times and reorganisation in 2008 and 2009, the Polish shipbuilding and repair industry has regained its strength and competitiveness. Thanks to the experiences and knowledge gathered over the past, the Polish shipbuilding and repair industry is one of the strongest in Europe. At the same time, the Poland shipbuilding industry faces enormous competition from shipyards in South Korea, Japan, China, and Germany (Global Security 2016a).

8. Estonia

In Estonia, shipbuilding sector includes the following activities: building of ships and floating structures, building of pleasure and sporting boats, and repair and maintenance of ships and boats. The sectors of shipbuilding and ship repair and maintenance are very closely entwined. The largest company in the area is the Baltic Ship Repair Company (BLRT), which formally by classification belongs to the repair and maintenance sector. The BLRT Group AS had a turnover of € 410 million in 2014. The group has 4,000 workers, out of which 1,800 are working in Estonia (BLRT 2016). BLRT Group AS includes 52 companies in seven countries. The group's activities are shipbuilding, ship-repair, production of large-scale metal constructions, metal processing, machine building, medical and technical gases.

The BLTR Group purchased Turku Repair Yard in Finland in 2007, which has the largest dry dock in Northern Europe. The joint venture of Fiskerstrand BLRT was formed together with Norwegian Fiskerstrand Verft shipyard, also in 2007. The main products of the joint venture have been barges for the fish farming industry. Together with the Norwegian company, the BLRT bought a Norwegian ship design company named Multi Maritime in 2010. In 2010, the BLRT Group also bought a shipyard Baltijos Laivu Statykla and Baltic Engineering Centre in Klaipeda, Lithuania. After those purchases, the BLRT Group has two shipyards, one in Tallinn and another in Klaipeda. The Finnish company Wärtsilä and the BLRT Group set up two joint ventures, one in Estonia (the joint venture is owned 51% by Wärtsilä and 49% by the BLRT Group) and another in Lithuania. The establishment of these service companies is an integrated part of applying the total service supply concept (Wärtsilä 2015). The group's structure is quite diversified as there are several subsidiaries dealing also with oil transit and cargo services, as well as production of gas used in welder works. The group has a port in its territory in Tallinn, Kopli peninsula (The Russian-Baltic port).

The second largest shipbuilding company is Baltic Workboats AS in Saaremaa, with a turnover of € 22 million in 2014 and more than 150 workers in the end of 2015. The company produces aluminium boats

using knowhow of Finnish workboat producer Marine Alutech Oy. The company has produced, for example, aluminium pilot boats for Estonian, Latvian and Lithuanian pilot services. The company manages the entire production process from design to launch (Baltic Workboats 2016). Other companies located in Saaremaa are building pleasure and leisure boats. The companies are AS Luksusjaht, renovating and building yachts with a turnover of € 14 million in 2014 and AS Saare Paat, building small fishing boats with a turnover of € 2 million. Saaremaa has become a location for a small cluster of companies building small ships and boats for fishing. The activities of these companies have been supported by the cluster development programme, started by the Enterprise Estonia in 2008. The particular programme supported the development of a cluster of building small ships in the Estonian islands and Western Estonia (Enterprise Estonia 2015).

8.1. Competitive situation

BLRT has been the largest shipbuilding and -repair company in the Baltic States. It has developed well and combined its production capacities to meet the needs of sophisticated markets with specific demands. The company has been producing floating structures for Norway's fisheries and for wind farms located in sea area (offshore wind farms). The company has diversified its production capacities, especially in Estonia and Lithuania, and has managed to keep a competitive quality-cost ratio. The other companies in the sector are small and medium-sized companies and producers of niche products. They use local resources and their labour costs have been competitive. There is a small cluster of producers on the Estonian islands, where costs are lower and local tradition plays an important role in developing of this sector.

The demand for niche products is fluctuating. Demand for some products depend on public support for particular activities and has been declining during economic crisis. The increase of costs which stopped during the economic decline could be a threat during economic recovery. The companies have been using welder specialists from China, Ukraine, and Romania, and there is a permanent problem related to the limited number of work permissions for workers from non-EU countries.

9. Latvia

The Latvian shipbuilding sector comprises four major enterprises (Riga Ship Yard, Tosmare Ship Yard, Bolderaja Ship Yard and Mangali Ship Yard) which are predominantly active in the ship repair sector, although some amount of new construction work has also been carried out at two of the enterprises, Riga Ship Repair Yard and Tosmare (Maritime Cluster Analysis 2012).

The Riga Shipyard serves European and Scandinavian customers focusing on ship repair, conversion and shipbuilding. Riga Shipyard co-operates with all classification societies, major equipment and paint manufacturers, logistics and shipping companies. The total turnover of the company was € 18 million in 2014 (€ 262 million in 2012) (Riga Ship Repair Yard 2016). Second largest company Tosmare, located in Liepaja, had a turnover of € 5 million in 2014 (Tosmare 2016). These two companies are also listed on Riga Stock Exchange.

9.1. Competitive situation

In terms of strength and weaknesses of the Latvian shipbuilding sector, labour costs are low in comparison with Nordic Baltic Sea yards. This provides a clear cost advantage, although it is undermined partly by higher levels of overhead costs and lower productivity. In Latvia, Riga shipyard holds aging assets of experienced marine and naval shipbuilding engineers and labour force, as well as mechanical equipment as floating docks, cranes and machinery are in dire need for improvements and investments. At the same time, the capacity in ship repair and shipbuilding yards has physical potential to increase outputs, either through improving productivity or by increasing employment. Meanwhile not only skilled labour and technology play a role in securing successful business but essentially also the knowledge of neighbouring countries' markets and the lack of language barriers with Russia, Ukraine, Belarus and other CIS countries (Maritime Cluster Analysis 2012).

10. Lithuania

Lithuanian shipbuilding and ship repair sector includes building of all type ships and floating structures, repair of ships and metal structures, machines, auxiliary and other ship equipment. Shipbuilding industry has significant impact on Lithuania's economy (MARTEC II 2014). In 2010, Lithuanian shipbuilding sector consisted of 114 enterprises with more than 5,100 employees and turnover of € 246 million (Mickeviciene et al. 2012). Shipbuilding sector together with shipping, ports and recreation and tourism sectors account for nearly a quarter of all marine industry jobs in Lithuania (Viederytė 2012).

The Lithuanian shipbuilding and ship repair sector is one of the promising sectors in the country thanks to its ability to provide higher value added products, such as building new ships using conventional and renewable energy resources (wind, solar and wave energy), develop propulsion systems with higher efficiency factors for new ships, et cetera. The activities of this sector contribute significantly to socio-economic sustainability. In addition, the environmental impact of conversion processes of shipbuilding and repair is minimised by providing new technologies, eco-innovative building and retrofitting processes (Study on Blue Growth 2013). Lithuanian shipbuilding and ship repair sector is not supported by the state (MARTEC II 2014).

The ship repair segment consists mainly of minor repairs, maintenance and conversion. Nowadays, the shipbuilding is usually a project-based activity. More regular trade relations are maintained with Denmark, Germany and Norway. The exports to Norway consists mainly in ferries. In 2009, exports of vessels and other floating structures amounted to around € 133 million (49% of combined turnover in the sector) and included seven countries of destination. In the period between 2004 and 2009, Lithuanian shipbuilding and repair companies co-operated with 22 countries in total (Study on Blue Growth 2013).

Lithuanian shipbuilding and ship-repair industry includes two key companies – the Western Shipyard Group and the Western Baltija Shipbuilding. The Western Shipyard Group is one of the largest corporations in Lithuania (1,900 employees), incorporating 23 companies. It specialises in shipbuilding, ship repair and conversion, port stevedoring and warehouse services, metal construction production, metal processing and hot galvanisation, technical supply and transport services. The Western Shipyard Group invests constantly in the implementation of renovation and modernisation in their up-to-date facilities. In 2011, the Western Shipyard and the Finnish company MacGregor established their joint

company, MacGregor BLRT Baltic, which is a global level ship-crane, hatch cover, ramp production and repair company (SC Western Shipyard 2016).

The Western Baltija Shipbuilding is a part of Western Shipyard, which belongs to the large Estonian corporation – the BLRT Group. The main direction of the Western Baltija Shipbuilding strategy is building ‘turn-key’ vessels of different types: tugs, supply vessels, ferries, fishing trawlers, jack-up and transformer platforms for renewable energy and other special purposes (Study on Blue Growth 2013).

10.1. Competitive situation

Lithuanian shipbuilding enterprises are known to have a good prospect for growth (MARTEC II 2014). Lithuanian shipbuilding sector is changing direction and transforming toward building more complex ships of higher value added. Providing practical and cost effective solutions for new eco-innovative ship repair and retrofitting processes is a new challenge and opportunity for Lithuanian shipbuilding and repair yards (Study on Blue Growth 2013).

The main challenge lies in being ahead of competitive advantage of neighbouring yards, not only in terms of costs but also general business development and overall market strategy. Niche market such as offshore business (drilling platforms, rigs, mechanical equipment, special customised cranes, floating barges and others) is also an opportunity not to be missed and today.

11. Russia

After the collapse of the Soviet Union, the Russian shipbuilding industry has undergone deterioration. The shipbuilding sector has suffered from a lack of private investments, which has prevented the commercial shipbuilding from developing, whereas the military shipbuilding still holds the dominant position, which it had during the Soviet times. Moreover, Russia has mostly invested in the development of its port capacity particularly in the Baltic Sea and the Far East. However, the Russian maritime cluster has recently received increased attention and funding, particularly due to the growing interest in the Arctic hydrocarbon fields and sea routes as well as the continuous importance of energy exports for the Russian economy, and can be considered to be experiencing a rebirth. The Government of Russia has even classified the shipbuilding industry as one of the strategic sectors of the economy and adopted a specific development programme, which aims at quintupling the Russian shipbuilding output by 2030. In this development programme the Russian shipbuilding sector is divided into three clusters: the robust Northwest Russia requiring modernisation, the Southern Russia concentrating on shipbuilding in SEZs (special economic zones), and the Far East with a new modern shipyard complex (BOFIT 2012b; Vorotnikov 2012). Particularly the Far-Eastern complex seems to be the future priority for the state because of the active oil and gas production operations requiring also new maritime capacity in the area (Maritime sector development in the global markets 2013).

The Russian economy is highly dependent on the energy export revenues as oil and gas revenues constitute half of the budget and over 70% of the exports of goods in Russia (Rosstat 2016). The development of the Russian maritime sector is largely guided by the needs of the country’s energy industry and if the Russian economy remains energy-driven, the situation is not likely to change in the

foreseeable future (Maritime sector development in the global markets 2013). On the contrary, the energy production is shifting north to increasingly demanding Arctic conditions, which requires considerable investments and completely new technological solutions also from the supporting maritime sector. While the Russian Arctic is estimated to hold the half of the world's untapped hydrocarbon resources, the development of these Northern regions is gaining increasing attention and investments from the state as well as businesses (Ernst & Young 2013).

Of particular interest is the Northeast Passage, the Arctic sea route along the Eurasian northern coast, which provides a shorter and thus cheaper alternative to the southern Suez Canal route to the growing Asian markets. However, due to the almost non-existing infrastructure, a lack of adequate ice-going vessels and emerging disputes over the waterway rights, the Northeast Passage is not expected to emerge as a large-scale international transport route in the near future. Although the period during which the route is navigable is lengthening (currently open between July and November), heavy investments are still required in the Arctic port infrastructure, satellite coverage and rescue system, let alone the construction of new ice-capable LNG tankers as well as the icebreakers necessary to escort their voyage. Although the need for such new vessels can already be recognised, the concrete orders are expected to surge only after the final investment decisions of the Arctic energy projects have been passed (Arctic Business Scenarios 2015).

The Russian shipbuilding activities are spread between the North-Western, Southern and Far-Eastern parts of Russia. Currently, the industry is led by the cluster in the Russian North-West, which benefits from a long tradition in shipbuilding. Today the region accounts for 72% of Russia's total shipbuilding production volume and over 80% of the related R&D. Almost 40% of all 170 Russian shipbuilding enterprises are located in the Russian Northwest (Doing Business in St. Petersburg 2015). At the same time, while having sea ports also by the Black Sea and the Pacific Ocean, the Baltic Sea is the main sea route for the country's foreign trade. Crude oil and petroleum products constitute the majority of the maritime transports, and one third of Russia's total oil exports are transported through the Russian Baltic Sea ports. Russia is constantly increasing the export capacity of its Baltic Sea ports and Ust-Luga in particular in order to become less dependent on third-country trans-shipments (BOFIT 2012a).

The general structure of the Russian maritime industry is relatively centralised due to the high state involvement in the sector's development. The state-owned United Shipbuilding Corporation (USC) accounts for about 80% of the shipbuilding orders in the country (Vorotnikov 2012). This St. Petersburg-based corporation was established in 2007 to unite the government's shipbuilding, repair, and maintenance subsidiaries in the Western and Northern parts of Russia and in the Far East, and to strengthen the state's control over the industry (Moscow Times 2013a; Staalesen 2013b). It includes 22 shipyards and 9 research institutions. However, the USC has recently received a lot of criticism due to its poor performance – the majority of enterprises in this corporation are continuously unprofitable. This has resulted from outdated facilities, slow renovation, and more expensive and time-consuming shipbuilding compared to foreign yards. Even President Putin has expressed his dissatisfaction with the delayed contracts, and the head of the corporation was changed in May 2013 (Pynnöniemi 2013). The company's new strategy requires investments totalling over \$ 30 billion by 2030 and abandoning of regional sub-holdings in favour of three new military and two new civil production divisions. This radical restructuring can result in the shutdown of St. Petersburg's Baltic Shipyard and Admiralty shipyard and moving their operations to the new facilities (Moscow Times 2013b). Ineffectiveness of the Russian maritime sector has resulted in a considerable lack of adequate equipment in the Russian offshore oil and gas industry and thus vessels are mainly being built abroad. To fix the unfavourable situation, the

Russian Government considers the establishment of a new shipbuilding consortium, which would be led by Rosneft. The new group would include partnership also from OSC as well as Gazprom Bank, and would be responsible for modernising the aged naval yards of Zvezda in the Russian Far East and Roslyakovo in Murmansk. Particularly Zvezda is to become a new super-yard developing and producing offshore petroleum equipment (Staalesen 2013a).

The Russian Government aims to breach the technological gap between the Russian shipbuilding industry and the European and Asian shipbuilding industries. In order to facilitate technology transfer and simultaneously improve the quality of Russian vessels it has established joint production for ships and maritime equipment with foreign companies. The Russian maritime industry has co-operation relationships with shipyards in Finland, France, Norway, Singapore and South Korea, among others (Maritime sector development in the global markets 2013; Motorship 2013). The Russian shipyards co-operate increasingly with foreign shipyards by dividing different phases of ship production within the yards. A concrete example of this kind of co-operation is the Finland-based Arctech Helsinki Shipyard, currently operating in the ownership of the USC. The icebreakers built in the Arctech Helsinki Shipyard have been designed in Finland, the hulls constructed in the Russian shipyards of Yantar or Vyborg, and afterwards the vessels have been returned to Helsinki for finalisation.

11.1. Competitive situation

Regarding the future of the Russian maritime sector, the maritime industry can be considered to hold significant growth potential but the industry's modernisation will certainly take time. Russia has fallen behind other shipbuilding nations in terms of technologies and knowhow. The current Russian expertise is mostly restricted to military shipbuilding, for instance submarines and naval vessels, and the industry is not export-oriented or even present at the international market. The commercial shipbuilding capacity is focused on building hulls, and advanced technologies and equipment are usually imported. As shipbuilding industry can be considered a strategic sector in Russia, the state plays a leading role in its development as the main customer for vessels, the owner of the key shipyards, and the funding provider. However, the strong roles of both the Russian state and naval industry in the country's maritime industry have hindered commercial shipbuilding from developing. Since the shipbuilding industry has been operating in an environment in which it has not been faced with competition and large shipyards have been mostly managing on the state's orders, the industry has not been forced to develop its cost efficiency, technologies and knowhow (BOFIT 2012b; Laaksonen & Mäkinen 2013). A clear indication of the domestic shipyards' low competitiveness is the fact that Russian private companies also prefer foreign shipbuilders – currently only 6% of the orders from private Russian ship-owners are placed to domestic shipyards (Vorotnikov 2012).

The existing Russian fleet is in need of rapid and broad modernisation and Russia aims to diversify the legacy of the military shipbuilding and increasingly engage in the building of civil vessels. However, the concern about the state of the Russian shipbuilding industry is nothing new. The Russian Government has established several policies since the 1990s to support the maritime industry's development, which have not yet proven very effective. For instance, the creation of the USC in 2007 was a part of the Strategy of shipbuilding development until 2020 and for the further perspective, but the holding company is still in process of consolidating and developing the co-operation within the subsidiaries. The state-private interaction has not brought significant results either in terms of increased competitiveness. Indeed, the government policies seem to have focused more on collecting the

relevant actors inside the same holding instead of supporting the formation of natural business networks and clustering (Laaksonen & Mäkinen 2013; Arctic Business Scenarios 2015).

12. Conclusions

The shipbuilding industry went through major structural changes in all the Baltic Sea region countries during last thirty years. The global competition from Asian countries and overcapacity of shipping fleet were two major factors behind these changes. Recently also low oil prices reduced exploration and development activities, which resulted in sharp decline in demand for offshore vessels.

Quite a different production pattern emerged after these changes, the common rule being that total volumes of production diminished substantially but specialisation made possible to maintain some high value sub-areas of production as cruise ships or specialised vessels to serve offshore industry. Denmark and Sweden practically closed down their shipbuilding industry. Germany at the same time remained as a leading shipbuilding country in Europe and has ambitious plans for the future. Norway and Finland continued as competitive producers in specific subsectors such as cruise ships, offshore vessels and icebreakers. Poland, being an important European level shipbuilding country, restructured its industry and on much lower level of production capacity has some competitive companies. The Baltic States continued with existing companies, some consolidation took place and some small and medium-sized companies were successful in certain niches as workboats. Companies from these countries did also subcontracting for some major companies in the region.

Russia has its own problems and controversial conditions for development of shipbuilding industry. On one side, there is a need and recognised political will to increase domestic shipbuilding and purchase ships from producers in other countries. Modernisation of technical capacities of Russian shipyards has also been an important issue. Sanctions imposed on Russia resulted in a ban on further supplies of modern marine and shipbuilding technologies to Russia.

Some important ownership changes took place, which supported functioning of clusters located in the Baltic Sea region, acquisition of Turku Shipyard by Meyer Werft being one example. The co-operation between companies with different technical skills and cost structure, combining specific shipbuilding competences with competences of companies providing innovative engineering services, would be one comparative advantage of the Baltic Sea region.

The demand side factors are also important for growth of shipbuilding in the region. Production of the region could be competitive not on cost base but first all due to innovative technological solutions and environment-friendly approach. Improving living conditions in other areas of potential demand and preferences for higher quality products have also positive impact on demand for ships produced in the Baltic Sea region. Demand for new cruise ships is also dependent on improvements in welfare and possibilities for risk free global shipping.

References

- Arctic Business Scenarios (2015). Arctic Business Scenarios. Report ordered by Norwegian Shipowners Associations. <http://www.rederi.no/arctic-business-scenarios.pdf>.
- Aszyk A. (2013). The sector's economic aspects; the example of Poland. Public Hearing. The European ship-repair and conversion sector – For a safer and cleaner maritime transport, Lisbon, 16 May.
- Baltic Workboats (2016). Official website. <http://www.balticworkboats.ee>. Retrieved on 26 February.
- BLRT (2016). AS BLRT Grupp, <http://www.bsr.ee>. Retrieved on 26 February.
- BOFIT (2012a). Russia moves to increase port capacity, especially in the Baltic Sea and Pacific coast. *BOFIT Weekly*, No. 36, September 7. http://www.suomenpankki.fi/bofit_en/seuranta/seurantaaineisto/Pages/vw201236_2.aspx?hl=ports%20russia, retrieved on 6.8.2013.
- BOFIT (2012b). Russia wants to quintuple its shipbuilding output by 2030. *BOFIT Weekly*, No. 46, November 16. http://www.suomenpankki.fi/bofit_en/seuranta/seurantaaineisto/pages/vw201246_2.aspx, retrieved on 10.10.2013.
- Caterpillar (2016). Caterpillar Marine Power Systems. <http://marine.cat.com/cda/layout?m=233421&7&id=1008002>. Retrieved on 10 October.
- Cruise Business Online (2013). Norwegian know how to build cruise ships. http://www.cruisebusiness.com/images/magazines/2013_02/cbr_2013_02-34-49.pdf. Retrieved on 26 February 2016.
- Damen (2016). Damen Shiprepair Götaverken <http://www.damen.nl/companies/damen-shiprepair-gotaverken>. Retrieved on 26 February.
- Danish Shipping Statistics (2015). Danish Ship-owners Association. <http://www.shipowners.dk>. Retrieved on 25 February 2016.
- Doing Business in St. Petersburg (2015). Shipbuilding cluster. <http://www.doingbusiness.ru/shipbuilding/cluster-business-sectors/shipbuilding-cluster/item>. Retrieved on 25 February 2016.
- Driftsrapport (2012). Breaking waves. NCE Maritime. Norwegian centre of Expertise.
- Enterprise Estonia (2015). <http://www.eas.ee/en/for-the-entrepreneur/cluster-development-programme>. Retrieved on 26 February 2016.
- Ernst & Young (2013). Arctic oil and gas. http://ey.com/publications/vwLVAssets/Arctic_oil_and_gas/FILES/Arctic_oil_and_gas.pdf. Retrieved on 25 February 2016.
- Euro infrastructure (2016). What's the condition of Polish shipyards? <http://www.euroinfrastructure.eu/en/infrastructure/whats-the-condition-of-polish-shipyards>. Retrieved on 14 February.
- Fiskerstrand BLRT (2016). <http://www.fblrt.com>. Retrieved on 26 February.
- Gdansk Shipyard (2016). History. About us. Official website. <http://www.gdanskshipyard.pl/en/polityka-prywatnosci>. Retrieved on 26 February 2016.
- Gerden E. (2015). Big changes coming to German shipbuilding. *Pacific maritime magazine – marine business for the operations sector*, no. 4 (33), May. <http://www.pacmar.com/story/2015/04/01/features/big-chnages-to-german-shipbuilding/336.html>. Retrieved on 27 February 2016.
- Global Security (2016a). Germany – Shipbuilding. <http://www.globalsecurity.org/military/world/europe/de-shipbuilding.htm>. Retrieved on 26 February 2016.
- Global Security (2016b). Poland – Shipbuilding. <http://www.globalsecurity.org/military/world/europe/pl-shipbuilding.htm>. Retrieved on 14 February.
- Henriksson M. & Huhtinen H. (2013). Arktisen alueen meriliikenteen kehitys vahvistaa Norjan asemaa. Kauppapolitiikka. <http://www.kauppapolitiikka.fi/public/default.aspx>. Retrieved on 26 February 2016.
- Hernesniemi H. (2012). Merenkulun toimintaedellytykset, kilpailukyky ja julkisen talouden sopeuttamistoimet. Taustaselvitys valtionvarainministeriölle. ETLA, Discussion Paper No. 1270.
- IMO (2008). MARPOL 73/78 Convention, Revised Annex VI. <http://www.imo.org/OurWork/Environment/PollutionPrevention/AirPollution/Documents/Air%20pollution/Resolution%20MEPC.176%2858%29%20Revised%20MARPOL%20Annex%20VI.pdf>. Retrieved on 20 February 2016.
- Jakobsen E. W. (2010). Deep changes in the Norwegian maritime industry: From conventional shipping to offshore and financial services. *MENEN Business Economics*. <http://etkunkskapsbasertnorge.files.wordpress.com/2010/10/04/oslo-shipping-exchange-deep-changes.pdf>. Retrieved 26 February 2016.
- Kockums (2016). <http://www.kockums.se/en/>. Retrieved on 26 February.
- Laaksonen E. & Mäkinen H. (2013). The potential for increasing inter – cluster cooperation between the Estonian, Finnish and North-West Russian shipbuilding cluster. *Baltic Regions*, no.4 (18), pp. 58-71.

BSR Policy Briefing 1/2016

- Marine Money Offshore (2013). KG structure – open for more than boxships.
<http://www.marinemoneyoffshore.com/node/5750>. Retrieved on 27 February 2016.
- MarinLink (2016). Marinlink.com. German shipbuilding prospects are fair & partly cloudy.
<http://www.marinlink.com/news/shipbuilding-prospects355928.aspx>. Retrieved on 25 February 2016.
- Maritime Cluster Analysis (2012). Maritime Cluster Analysis on the Central Baltic Region. SmartComp Research Report No. 1, December. Retrieved on 25 February 2016.
- Maritime Outlook (2015). Maritime Outlook. Norwegian Shipowners Association. <http://www.rederi.ro/Maritime-Outlook-2015.pdf>. Retrieved on 20 February 2016.
- Maritime Sector Development in the Global Markets (2013). Maritime Cluster Analysis on the Central Baltic Region. SmartComp Research Report No. 3, October. Retrieved on 25 February 2016.
- Maritimt Forum (2016). <http://maritimt-forum.no/om-oss>. Retrieved on 26 February.
- MARTEC II (Maritime Technologies as an ERA-NET) (2014). Lithuania - National Programme Information.
<https://www.martec-era.net/index.php?index=38>. Retrieved on 18 February.
- Meriaura (2016). <http://www.meriaura.fi>. Retrieved on 26 February.
- Meyer Werft (2016). <http://www.meyerwerft.com>. Retrieved on 26 February.
- Mickevičienė, R., Paulauskienė, T., Paulavičienė, S., Baužytė, R. R. (2012). Foresight Study (Lithuania). Generation BALT, South Baltic program.
http://www.generationbalt.eu/data/user/documents/Regional_Foresight_Study_Lithuania.pdf, retrieved on 18 February 2016.
- Moscow Times (2013a). Head of United Shipbuilding Corporation Fired After 11 Months. May 7.
[Http://www.themoscowtimes.com/business/article/head-of-united-shipbuilding-corporation-fired-after-11months/479614.html](http://www.themoscowtimes.com/business/article/head-of-united-shipbuilding-corporation-fired-after-11months/479614.html). Retrieved on 20 February 2016.
- Moscow Times (2013b). United Shipbuilding Corporation Faces Major Overhaul to Fight Slump. September 27.
<http://www.themoscowtimes.com/business/article/united-shipbuilding-corporation-faces-major-overhaul-to-fight-slump/486680.html>. Retrieved on 20 February 2016.
- Motorship (2013). Russian commercial shipbuilding faces serious crisis. May 31.
[Http://www.motorship.com/news101/comment-and-analysis/russian-commercial-shipbuilding-facesserious-crisis](http://www.motorship.com/news101/comment-and-analysis/russian-commercial-shipbuilding-facesserious-crisis). Retrieved on 20 February 2016.
- MSR Gryfia S.A. (2016). About the Yard. Official website. http://www.msrgryfia.pl/en/o_stoczni.php. Retrieved on 18 February.
- Nauta Shiprepair Yard (2016). Company. Official website. <http://www.nauta.pl/index.php?company>. Retrieved on 18 February.
- Pynnöniemi K. (2013). Venäjän varusteluohjelma ja Kaukoidän telakka: huomiota ajankohtaseista keskustelusta. The Finnish Institute of International Affairs.
http://www.fiia.fi/en/blog/418/venajan_varusteluohjelma_ja_kaukoidan_telakka_huomiota_ajankohtaseista_keskustelusta. Retrieved on 26 February 2016.
- Remontowa (2016). About us. Official website. http://www.remontowa.pl/index_en.php?n=86. Retrieved on 18 February.
- Reve (2009). Norway – a global maritime knowledge hub.
<http://web.bi.no/forskkning/papers.nsf/WReserachReports>. Retrieved 6 August 2013.
- Riga Repair Shipyard (2016). <http://www.riga-shipyard.com>. Retrieved on 27 February.
- Rolls-Royce (2013). http://www.rolls-royce.com/careers/working_for_us/our_location/norway. Retrieved on 20 February 2016.
- Rosstat (2016). Foreign trade of the Russian Federation.
http://www.gks.ru/bgd/regl/b11_14p/lssWWW.exe/stg/d03/26-01.htm. Retrieved on 26 February.
- SC Western Shipyard (2016). About us. Official website. <http://www.wsy.lt/index.php/en/about-us/history>. Retrieved on 18 February.
- Staalesen A. (2013a). Going Arctic, Rosneft eyes acquisition of Murmansk shipyard. *Barents Observer*, August 12.
[Http://barentsobserver.com/en/energy/2013/08/going-arctic-rosneft-eyes-acquisition-murmansk-shipyard12-08](http://barentsobserver.com/en/energy/2013/08/going-arctic-rosneft-eyes-acquisition-murmansk-shipyard12-08). Retrieved on 20 February 2016.
- Staalesen A. (2013b). New chief shipbuilder mulls Arctic shift. *Barents Observer*, August 14.
[Http://barentsobserver.com/en/business/2013/08/new-chief-shipbuilder-mulls-arctic-shift-14-08](http://barentsobserver.com/en/business/2013/08/new-chief-shipbuilder-mulls-arctic-shift-14-08). Retrieved on 20 February 2016.
- Study on Blue Growth, Maritime Policy and EU Strategy for the Baltic Sea Region (2013). Annex 1.7: Country Fiche Lithuania. MARE/2012/07 - REF. NO 1.
<https://webgate.ec.europa.eu/maritimeforum/sites/maritimeforum/files/Annex%201.7%20-%20Country%20Fiche%20%26%20Annex%20Lithuania.pdf>. Retrieved on 18 February 2016.
- STX Finland Oy (2011). STX Finlandille merkittävä offshore alinhanke. STX Finland Oy Press Release 12.10.2011.
- STX Europe (2012). <http://www.stxeurope.com>. Retrieved on 10 December.

BSR Policy Briefing 1/2016

- Technip (2016). <http://www.technip.com>. Retrieved on 26 February.
- Tosmare (2016). <http://www.tosmare.lv>. Retrieved on 26 February.
- Turku Repair Yard (2016). <http://www.turunkorjaustelakka.com>. Retrieved on 26 February.
- VDR (2016). Verband Deutscher Reeder. Merchant shipping in numbers. <http://www.reederverband.de/en/facts-figures.html>. Retrieved 26 February 2016.
- Viederytė R. (2012). Maritime sector impact on the economy of Lithuania. Kaunas University of Technology. *Economics and Management*: 2012. 17 (1). ISSN 2029-9338 (online).
- Vorotnikov V. (2012) Russia approves shipbuilding program. *Baird Maritime*, 9 October. http://www.bairdmaritime.com/index.php?option=com_content&view=article&id=13485:russia-approves-shipbuilding-program&catid=113:ports-and-shipping&Itemid=208. Retrieved on 26 February 2016.
- Wärtsilä (2016). Wärtsilä Annual Report 2015. <http://www.wartsila.com>. Retrieved on 26 February 2016.

Arctic shipbuilding – Case: Arctech Helsinki Shipyard

Esko Mustamäki

1. Background of Arctic shipping

Arctic shipping has been a popular topic during the last years. It is easy to think that Arctic shipping is a new invention. However, it is not. Humankind has travelled by sea since prehistoric times. Tribes, who had migrated to the Northern parts of the globe, used their boats whenever the ice conditions in the water systems allowed. Over time, they developed their boats to cope better with the ice conditions they encountered. This was the beginning of Arctic shipbuilding.

Already about 325 BC did the Ancient Greek geographer and explorer Pytheas of Massalia, today known as Marseille, reach areas beyond the Arctic Circle as he has been able to report both about midnight sun as well as the polar night. Pytheas' description of his voyage of exploration is widely known in Ancient history. Unfortunately, it has not survived.

Since the 15th century, there was a growing interest among explorers to find alternative routes both from the Atlantic Ocean to the Pacific Ocean as well as from Europe to Asia. Both routes, the Northwest Passage and Northeast Passage or Northern Sea Route as it is better known today, are extremely demanding even today, not to mention five hundred years ago.

Many explorers travelled to the Arctic in 19th century looking for the Northwest Passage, the Northeast Passage or trying to reach the North Pole. Eventually all these goals were reached. It was only when the exploitation of Arctic mineral deposits and oil and gas reserves became interesting late 20th century when the Arctic shipping started to grow. At the same time the first generation of Polar Icebreakers were built in Canada, the Soviet Union, the United States and mainly in Finland.

2. Arctic shipping in the future

There is a growing global interest toward the Arctic region and its recourses in the global economy by Asian and European powers. The Arctic oil and gas reserves have been estimated (Ernst & Young) to be equivalent to 412 billion barrels of oil. The value of these oil and gas reserves, based on today's price level (February 2016) is about € 12,000 billion. Is this a big enough driver to invest in Arctic oil and gas? Maybe not for all. However, I am sure that new investment decisions are done also at this low energy price level.

All new investments results in growing need for suitable fleet of icebreaking offshore vessels, oil and gas carriers and other vessels. The investment in the fleet is usually only a small part of the total investment. But for the shipbuilding industry it is certainly a very important part. Already today, there are plans to renew the Polar Icebreaker fleets in Canada, China, Germany, Russia and the United States. In addition to

BSR Policy Briefing 1/2016

these planned state owned icebreakers a number of commercial vessels are needed for each field that are developed.

Future Arctic oil and gas exploitation will require new tonnage to support the operations. There are estimates concerning what the number of needed vessels could be. These figures are naturally irrelevant until investment decisions to start oil or gas production have been made.

In addition to oil and gas, there are also huge mineral deposits in the Arctic region. Exploitation of these deposits will create a need for tonnage, in a similar way as the oil and gas does. The traffic in the Arctic will mainly be connected to exploration, construction of necessary production facilities and supporting infrastructure and transportation of the produces oil, gas and minerals from the site to the customer. In addition, there will be a slowly growing traffic between Europe and Asia using the Northern Sea Route during the summer months when the ice conditions allow such traffic.

3. Helsinki shipyard

The history of Helsinki shipyard dates back to 1865 when two local businessmen received the approval from the senate to build a shipyard on area quite far from what was the city centre of Helsinki at that time. The operation continues today at the same location, but now very close to the city centre.

During the past 150 years, the shipyard has built more than 500 vessels. This has required more than 1 000 000 tonnes of steel. The ship types built at Helsinki shipyard has varied during the years. In early days, the shipyard built all types of small vessels. After the war icebreaker became an important ship type for the yard. In the end of last century, ferries and cruise vessels were the dominant vessel types. In fact, the yard has built about 60% of all icebreakers in the world.

We have today about 2 000 000 m³ indoor building facilities, including a covered building dock measuring 34 metres in width and 280 metres in length. These allow efficient high quality production, which is necessary in the hard competition shipyards worldwide face today. The shipbuilding process from start of production until the launching the vessel take place under cover, which is a big advantage keeping in mind what the weather conditions in Finland may be.

It is not enough to have state of the art production possibilities; you also need to be highly specialised. Helsinki shipyard has during the last 50 years been involved in ship types that are technologically advanced. This list includes vessels like ferries, cruise liners, naval crafts, hovercrafts, Arctic cargo vessels, Arctic offshore vessels and icebreakers.

If you wish to be successful in any special vessel niche, you need to invest in research and development. During the years, many innovations have seen daylight in connection to the development work done to new buildings built at the yard. Such development work is usually done in co-operation with research institutes, universities, equipment manufacturers, et cetera.

The most interesting product innovations done in connection to new buildings at Helsinki yard are Double Acting Ship, the first AC-AC icebreakers and the Electrical podded propulsion system.

BSR Policy Briefing 1/2016

The double acting ship is optimised to operate bow first in open water and stern first in heavy ice conditions. This concept was developed in co-operation with Aker Arctic Technology Inc. The first AC-AC icebreakers Otso and Kontio built at the yard in the mid-1980s. Strömberg developed the AC-AC drive (today ABB). The power transmission and propulsion control systems of the modern cruise ships today are mostly based on this idea of the converter based propulsion system. The yard together with the Finnish Maritime Administration and ABB developed the electrical podded propulsion system. This propulsion system is today known as Azipod®.

What are then the next innovations? Environmental requirements will be more and more stringent, which has led to growing research in this field. It will lead to innovations that will also be used in icebreakers. A lower CO₂ emission level is the target.

4. Arctech Helsinki Shipyard

In 2010, United Shipbuilding Corporation (USC) and STX Finland Oy agreed to set up a new company Arctech Helsinki Shipyard Inc. The new company was a 50/50 joint venture, and combined the expertise in shipbuilding of Helsinki shipyard, the operations of which Arctech took over by the deal, and Russia's leading shipbuilding group. The 2007 founded USC is 100% owned by the Russian Federation, it owns more than 60 shipyards and design offices in Russia. USC focuses on the development of both civil- and naval shipbuilding industries in Russia and employs more than 80,000 employees.

In the year 2010, the importance of the Arctic region was already growing, it had entered into an exciting era whereby climate, political and economic changes were facilitating unprecedented access to the region, fuelling great expectations in the shipping sector. Navigating safely across the Arctic region requires polar icebreaking ships capable of operating in a variety of challenging ice conditions – ships that are both ice-strengthened and 'winterised'. The motivation behind setting up the joint venture was therefore partly the expected significant increase in the Arctic market, with regards to vessels required for activities in harsh Arctic environments. Helsinki shipyard had exactly the know-how needed for this.

The new joint venture did not change the day-to-day running of the shipyard. One important new opportunity was the venture opened up new opportunities for the business as there was now the Russian maritime cluster, in addition to the Finnish cluster, from where the yard could source subcontractors or other suppliers.

In 2014 STX Finland sold its shares in Arctech to USC, as part of the group's global restructuring. USC became then the sole owner of Arctech. The weakening STX, which had been in the driver's seat of the joint venture in 2010, had by 2014 become a burden for the yard. The 2014 arrangement is thus one more positive move for the yard.

By today Arctech has delivered four new buildings and six more are in the order book. The value of present order book is some € 700 million. In addition to our own close to 600 employees, including close to 100 designers, we employ about 400 subcontractors at our premises. The present order book extends to spring 2018.

The next delivery from the yard will be new building 510, the world's first LNG powered icebreaker for the Finnish Transport Agency. The almost 110 metres long vessel differs from all previous icebreakers in many

BSR Policy Briefing 1/2016

ways. Finnish technological innovations, such as electric propulsion units and an effective oil recovery system integrated into the hull, will be installed in the vessel. The unique icebreaker will be powered by engines burning both diesel and liquefied natural gas (LNG), which will significantly reduce both carbon emissions and fuel costs. Upon completion, the icebreaker will be the most environmentally friendly icebreaker in the world.

The new icebreaker has been designed especially for the demanding icebreaking operations in the Baltic Sea, and it will be fitted for oil recovery and emergency towing.

The naming ceremony of the new-generation icebreaker built at Arctech Helsinki Shipyard took place on December 11 2015. In keeping with old shipbuilding tradition, a bottle of champagne was broken against the ship's hull during the name-giving event. Paula Risikko, Second Deputy Speaker of the Finnish Parliament, serves as the vessel's godmother. The name Polaris refers to both the North Star, an important navigational star for seafarers on northern seas, and to the polar class of the ship, enabling operations in multi-year ice conditions.

During the past decades, the volume of European shipbuilding has decreased strongly. Meanwhile the shipbuilding industry in Japan, South Korea and China has been growing and accounts today for more than 90% of the global shipbuilding volume. The remaining shipyards in Europe are highly specialised. This is the only option European yards to survive in the hard global competition. I believe the Arctic shipbuilding strategy implemented by Arctech will keep it among the succeeding yards in Europe.

Vitus Bering and Aleksey Chirikov



Arctech Helsinki Shipyard delivered the Icebreaking supply vessels Vitus Bering and Aleksey Chirikov to Sovcomflot in 2012 and 2013. Both the vessels are here pictured in the building dock after the launching of the vessels. Vitus Bering and Aleksey Chirikov are today operating in the Sakhalin area in Far East Russia, where they are supplying the Arkutun-Dagi oil and gas field.

Icebreaker Polaris



The next vessel to be delivered from Arctech Helsinki Shipyard, icebreaker Polaris is the first LNG-fuelled icebreaker ever built. The new icebreaker has been designed especially for the demanding icebreaking operations in the Baltic Sea, and it will be fitted for oil recovery and emergency towing.

Delivering sustainable and energy-efficient cruise ships

Jaana Hänninen, Tero Mäki-Jouppila and Kari Sillanpää

Executive summary

Cruise ship operators and shipbuilders are facing new kind of demands as sustainability awareness is rising among cruise passengers and other stakeholders. Expectations of environmental friendliness and responsible operation require that the whole maritime cluster act proactively and go beyond mere regulatory compliance. Only that way they can convey a credible message about the positive values associated with their products.

In addition to environmental friendliness, companies also have to take account of financial and social aspects, that is corporate social responsibility, CSR. Sometimes CSR and sustainability are seen as synonyms. In shipbuilding, sustainability has traditionally been understood to cover only the operational emissions and the means to reduce these. But, on a bigger scale, the CSR and sustainability have to cover all the different impacts over the whole lifecycle of a cruise ship: environmental, social, and economical.

Figure 1. Cruise ship's lifecycle



1. Sustainable cruise ships

As the designer and builder, shipyard has an important role with respect to the final quality of a new vessel. With proper design and the choice of right technical solutions, the shipyard can greatly affect the ship's whole lifecycle. Cruise ships are like small cities, starting with their own energy and water production, and ending with waste and garbage treatment systems. In between, they manage all hotel, accommodation, service and entertainment functions. A ship consists of a huge amount of equipment, pipes and ducts, and different kinds of construction, interior and insulation materials. We can ensure that

our products are sustainable by selecting more sustainable materials, and by taking into account the whole production chain, logistics, recycling, reuse possibilities, and longevity.

One of our main goals is to create added value for our customers. And even though sustainability is clearly an added value, it is still quite vague and difficult to measure. Since cruise passengers – as people in general – are nowadays increasingly concerned about sustainability, we have to be able to inform them about it in a credible way. In our opinion, accurate and transparent information plays a key role in the validation of the sustainability value. To reach that goal, we work actively with our suppliers to improve information collection and documentation on materials and working procedures.

2. Minimised environmental footprint

All environmental impacts have to be taken into consideration in ship design and operation. Cruise shipping can have many kinds of negative environmental impacts, but with a comprehensive approach to vessel design these impacts can be significantly reduced. Most of the various emissions or impacts are already regulated by the global or local maritime rules.

Figure 2. Environmental impacts



Emissions to air can be minimised by many means, starting with selecting cleaner fuels or, alternatively, utilising exhaust gas cleaning and burning process improvements like scrubbers and other purification or filtration methods, catalytic reactors and advanced main engine technologies, and by improving energy

efficiency. Such measures will reduce both fuel consumption and emissions. Operational improvements in waste handling and recycling reduce the need for waste incineration.

Emissions and effluents to water are minimised by selecting environmentally friendly hull coatings, and by using advanced wastewater and oily water purification systems, and ballast water treatment systems.

Optimised noise attenuation improves passenger and crew comfort and also reduces external noise under transit and harbour conditions. Good hull form and propulsion design reduce underwater noise characteristics and improve passenger comfort on-board. Wave forming can be minimised by means of advanced hydrodynamic design, which also guarantees low resistance, high propulsion efficiency and excellent seakeeping properties.

3. Energy efficient cruise ships

Reduced operation costs and environmental legislation are the main drivers of energy efficiency. The ever-tightening maritime environmental legislation forces shipyards and cruise lines as well as system and equipment suppliers to continuously develop energy efficiency to ensure compliance with the applicable and upcoming regulations. However, cruise lines and shipyards often collaborate to develop the ships even beyond the applicable regulations instead of contending themselves with compliance only. This brings positive publicity and, as regards energy efficiency, savings in fuel costs as well.

Over the years, the combination of improved individual equipment, optimised system design for varying operating conditions and more sophisticated demand-based control systems have enhanced the overall energy efficiency of cruise ships. The most recent developments have mainly focused on Waste Heat Recovery (WHR) technologies to increase cruise ships' waste heat recovery rate and the overall utilisation rate of the fuel energy content.

Modern tools for energy efficiency optimisation developed during the past decade, such as modelling and simulation software, bring along possibilities for improving the energy efficiency of ships reliably and effectively. For example, the advanced CFD-modelling software has raised the hydrodynamic design to the next level.

Lately, advanced and comprehensive on-board energy management systems have also provided increased information about cruise ships' energy flows. Increased awareness and information are the key factors for further energy efficiency development.

For us as a shipyard, it is important that we are able to offer cutting-edge cruise ships to our customers and that we are one of the forerunners in the field of energy efficiency. In the tough competition within the cruise ship building industry, a proven track record of energy-efficient cruise ships is a clear competitive advantage.

Generally, it can be said that the energy efficiency of cruise ships has annually improved by more than 3% for the past 15 years. To use our ships as an example, the cruise ships *Mein Schiff 3* and *4* built by Meyer Turku represent state-of-the-art in energy efficiency: they are ~30% more efficient than reference ships built during the past 10 years (reference to IMO Energy Efficiency Design Index, based on cruise ships built over the last 10 years). Energy-efficient solutions combined with environmentally friendly

technologies have enabled us to reduce CO₂ emissions by ~30%, NO_x emissions by ~58%, SO_x emissions by ~95% and particulate matter emissions by ~60%.

From a cruise line's perspective, economical operation and minimised environmental footprint are important values. Fuel costs constitute a large share of the overall operating costs of cruise ships and, therefore, energy-efficient operation enables more profitable business for cruise lines. In addition to the reduced fuel bill, the reduction in fuel consumption reduces emissions, thus decreasing the environmental footprint of a cruise ship. Environmental friendliness provides good marketing value for a cruise line.

From a system and equipment supplier's perspective, continuous product development is vital for ensuring provision of competitive products. The development work is often carried out in collaboration between the supplier and the shipyard. Through co-operation, both parties' competencies can be tapped to ensure an energy-efficient and well-functioning end product.

3.1. Challenges

Unlike most of the processes in land-based factories and power plants, which can be said to be stable compared to cruise ships, the processes on a cruise ship vary a lot according to the daily operation profile and the seasonal and ambient conditions in the operation area, and whether the ship is in port or at sea. The wide range of process variation sets challenges to the ship's system design and the energy efficiency optimisation in particular. To enable energy efficient operation under any circumstances, the control of different systems needs to be designed following the principles of demand-based control. Accurate technical operational information on cruise ship systems, systematic approach to energy efficiency optimisation and advanced dynamic simulation tools are the key factors for energy efficiency development.

3.2 Technical operational information

Understanding the cruise ship's energy flows is the key factor for increasing information and enabling further energy efficiency development. On-board energy management systems have developed significantly over the last few years. Comprehensive energy management systems can nowadays measure and monitor most energy flows on board, including primary energy sources, and electrical, heat and water-related energy flows.

Energy management systems are based on real-time energy flow measurement and monitoring. The systems encourage the operators to continuously improve their operational efficiency by providing advice on how to optimise the on-board operations. With the connection to onshore facilities, these systems provide the possibility to compare ship performance within the fleet. In addition, the sophisticated energy management systems can be used for system and equipment malfunction observation.

Figure 3. Energy flow-diagram, fuel energy utilisation

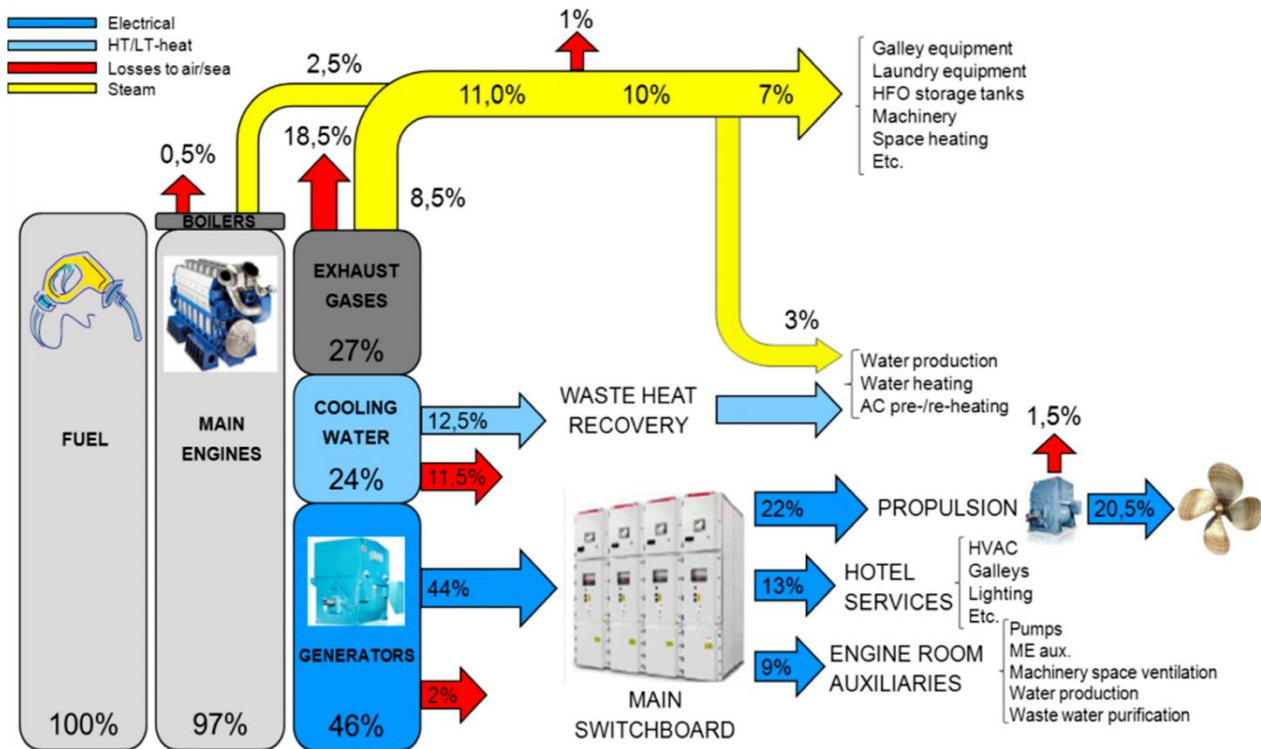

3.3. Systematic approach

The design and construction of a cruise ship is a complex and challenging project. It is very important that a systematic approach is followed throughout the project in every respect, including the energy efficiency aspects.

A systematic energy efficiency procedure starts with the baseline definition in the concept phase of a cruise ship design. After baseline definition, the energy efficiency targets are determined. When the baseline and targets have been set, the systematic energy efficiency work continues with further energy efficiency development and continuous follow-up during the project.

The energy efficiency work performed during the design phase includes several steps. Comprehensive energy efficiency comparison studies are performed for all main equipment generating or consuming energy to support equipment selection and procurement processes. Dozens of feasibility studies on potential implementation of novel and advanced technologies on the ship are carried out during the design process. To optimise system functionality and enable energy-efficient operation, all the ship's systems and control principles are included in the scope of energy efficiency work carried out during the design phase

Such systematic work will result in optimised system designs, enabling energy-efficient operation of a cruise ship. However, energy efficiency goals cannot be achieved if the operational crew is not oriented towards efficient operation. Attention needs to be paid to crew training and operation instructions in order to ensure operational efficiency. For example, the ship's operation manual for energy efficiency is created alongside the conventional operation manual, and training on energy-efficient operation is arranged for the crew, prior and after the ship's delivery. Continuous monitoring of energy efficiency

during actual operation also plays an important role with a view to successful operation. Energy management systems provide an opportunity for real-time energy flow monitoring for optimisation purposes, and the systems can also be used for verifying the feasibility of the implemented energy efficiency improvements.

Figure 4. Example of the results of continuous and systematic energy efficiency development

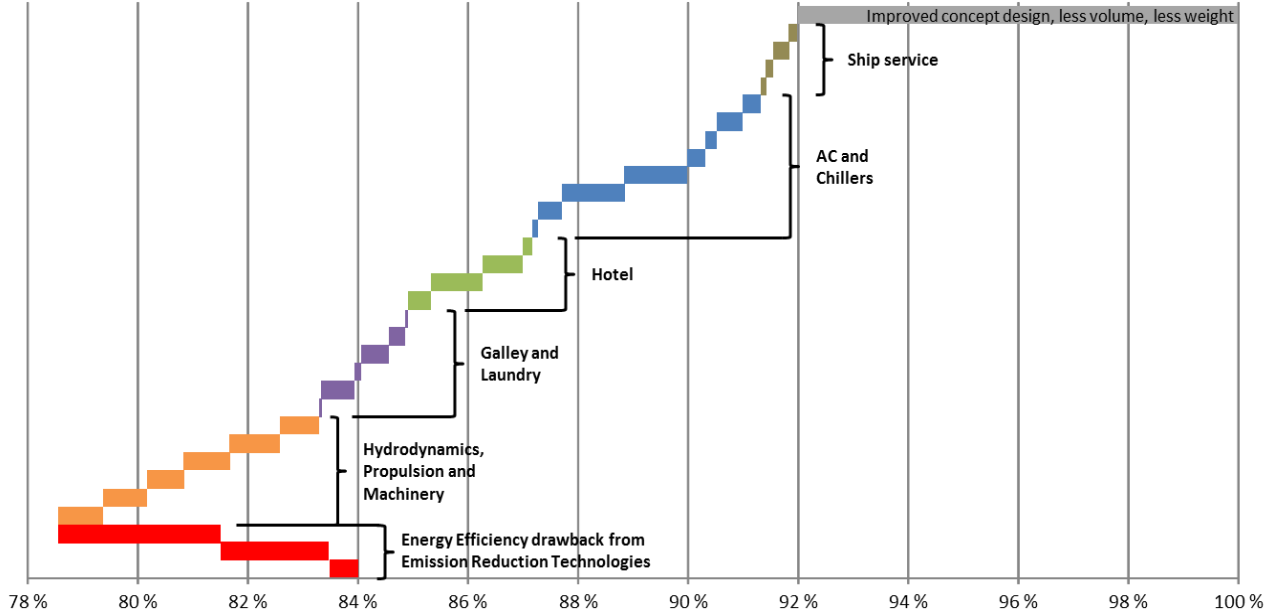

Environmental efficiency – Now !

Text by Wärtsilä, edited by Aslak Suopanki

Environmental efficiency is high on the agenda of both Wärtsilä and its customers. Hence, Wärtsilä has made significant long term investments to research and development in order to become the leading provider of environmental solutions for the marine industry. As a result, Wärtsilä now has the widest product portfolio and the most comprehensive reference list in the market in several of these solutions.

Emissions to air are to blame for a lot of detrimental effects, not only on the environment but also on our health. So there is a reason why also decision-makers are keen on acting. Hence, since the beginning of January 2015, ships sailing in SECAs (Sulphur Emission Control Areas) have not been allowed to use fuel containing more than 0.1% sulphur by weight unless they use alternative methods for compliance. Next up is 2020, when 0.5% sulphur limit in EU waters outside SECAs will come into force. IMO's regulations on cutting sulphur content to 0.5% on a global level comes into force by 2025 at the latest, affecting practically all vessels worldwide.

When it comes to sulphur regulations, shipowners basically have two options: switch to cleaner fuel or get rid of the sulphur using exhaust gas cleaning systems. The first option means switching to e.g. low-sulphur distillate fuel or to LNG (Liquefied Natural Gas). Opting for low-sulphur distillate fuel involves higher operation costs although the switch itself is not a big investment. Switching to LNG has other environmental benefits as it significantly reduces not only SO_x but also NO_x, CO₂ and particulate matter emissions. The second option – exhaust gas cleaning system, also known as a SO_x scrubber, will allow continued use of high sulphur fuel. While both LNG and SO_x scrubber are viable options for newbuilds, SO_x scrubber is typically economically more feasible for retrofitting existing vessels.

1. The first high-speed LNG-fuelled RoPax in the making

Wärtsilä has served up a smörgåsbord of green solutions for the world's first high-speed, LNG-fuelled RoPax ferry, which will sail between the Swedish mainland and Baltic outpost Gotland. It complies with several strict regulations, including domestic rules on particle emissions.

Many of the 60,000 residents of the tourist-magnet island consider the three-hour ferry ride to the mainland their highway, which in 2017 will get a bit cleaner as ship operator Rederi AB Gotland has ordered a new ferry with a crop of environmentally friendly technology from Wärtsilä. The new RoPax ferry will emit 15-20% less carbon dioxide than its traditional diesel-powered cousins, the two similar-sized ferries that today leave the mainland up to five times a day during peak season.

“This vessel will have a minimal environmental footprint”, said Håkan Johansson, Managing Director of Rederi AB Gotland, when the contract was penned in late 2014. *“Wärtsilä's know-how and experience with gas-fuelled vessels is unmatched in the industry”.*

The new ship will carry some 1650 passengers and has space below deck for a corresponding number of passenger cars, campers and busses, plus 1750 trailer lane metres. What will be the first LNG-fuelled high speed RoPax ferry in the world is now being built at the Guangzhou Shipyard International (GSI) yard in China. Once in operation, it will also be the first Swedish-flagged, LNG-powered passenger vessel. The use of LNG not only cuts CO₂, it brings down other emissions, which are strictly regulated, not least by the Swedish state which for several decades now has fought to clean up the Baltic. The ferries were never the bad guy, however – insufficiently treated wastewater and agricultural fertilizers were – yet every piece of the puzzle matters.

With LNG, there are several green benefits. *“There is no sulphur, so automatically you comply with sulphur rules in the Baltic”*, says Wärtsilä’s Göran Österdahl, General Manager in Marine Solutions sales. *“That is one of the beauties of LNG. Another environmental upside is extremely low levels of particulate matter. NO_x is at a level that is 80% lower than what the international rules require today, as Sweden demands less than 2 grams per kilowatt-hour. International rules call for around 10”*.

Wärtsilä also took great care to make sure its designs would fit in, literally – as the new safe-return-to-port rules for all newbuilds require, generally speaking, two separate engine rooms. *“It’s basically two ships in one”*, explains Österdahl, who says Danish ship designer OSK-ShipTech A/S needed to fit two of everything into a ship design originally made before this requirement was introduced. *“It was a bit of a challenge, but you need to make sure that if one part of the ship is damaged – through fire or flood – the ship retains engine power to make it safely back to port”*.

A lot of design action also took place in areas populated by passengers rather than by crew. Building a ferry is not just about getting people there and back swiftly; it is about keeping them happy on board, for example by using the LNG system to keep temperatures agreeable. *“You have to cool the ferries, especially in the summer. On this LNGPac – the storage and supply system – we have installed an energy recovery system, which basically, when the LNG heats up before it enters the engine, makes use of the cold for the air conditioner in the summers”*, Österdahl says. *“A lot of energy is spent to liquefy the natural gas and then you heat it up again. You have free energy that we just reuse for cooling the air conditioning system – that is an extra way of maximising the use of the energy”*.

And then there’s keeping down the noise without sacrificing deck space. *“We’ve got eight engines and two boilers so it’s tremendous trouble to fit in so many exhaust pipes that have to protrude from the ship”*, he says. *“The value of a passenger ship is of course the deck, and these funnels for all the pipes consume a lot of space”*.

The exhausts also need to be quiet. Traditional noise silencers take up a lot of space, which make them less than ideal for a passenger ship. The solution for the new ferry is a compact silencing system (CSS). *“It is, as the name says, compact. It doesn’t use a traditional big silencer that is quite wide in diameter; it uses several silencing elements as part of the total exhaust pipe”*, says Österdahl. *“We reduce the total width of the funnel by using the CSS”*.

The many component parts will also allow Rederi AB Gotland to tweak the sound. *“There is an extra high noise requirement since the port of Visby has special requirements within 200 metres from the harbour”*, says Österdahl. *“With the CSS you can tune the noise reduction a little bit as you like, as it has many elements and each elements attacks certain frequencies of the noise. We spent a lot of time together with the designer*

and the shipyard on fitting everything into the limited space available – many man-hours just to solve that piece of cake”.

The cake is made up of many more slices, many of them environmentally friendly. There is the updated hull design, for example, which maximises flow to the propellers. “*We spend a lot of time on the aft*”, Österdahl says. The list goes on: IMO-approved Wärtsilä Aquarius UV ballast water management system and an Oily Water Separator together with a Bilge Water Guard, to name a few.

2. The exhaust gas cleaning solution

Wärtsilä has been developing scrubbers for almost 10 years, and further strengthened its offering with the Hamworthy acquisition in 2012. Today Wärtsilä is the market leader with more than a hundred scrubbers sold or on order for over 50 vessels. “*Our operating hours amount to over 80,000 by now*”, says Britt-Mari Kullas-Nyman, Director in Retrofit, Environmental Solutions.

As discussed above, switching to LNG has many great benefits. However, it also comes with a heavier price tag – especially when retrofitting. A less costly alternative for now is installing exhaust gas cleaning systems, which offer a typical payback time of three to five years, depending on operational profile and trading pattern within the SECAs.

“Installing scrubbers has the lowest lifecycle cost. And with a suitable system the vessel can operate in all corners of the world”, says Wärtsilä’s Aslak Suopanki, Senior Technical Manager in the Retrofit team.

There are three SO_x scrubber techniques to choose from: open loop, closed loop and hybrid. The open loop scrubber is technically the simplest one, where the exhaust gas enters the scrubber and is then sprayed with plain seawater. As the sulphur oxide reacts with water, an acidic solution is first formed. No chemicals are needed as the natural alkalinity of seawater neutralises the acidity. The wash water is treated and monitored after it has passed the water treatment system – always included in Wärtsilä’s scrubber solution, before being discharged into the sea.

The closed loop is technically a bit more complicated as the water is being circulated inside the scrubber. Exhaust gas entering the scrubber is sprayed with water that has been mixed with caustic soda (NaOH) solution. Sulphur oxides in the exhaust react with this mixture and are neutralised in the process. A small bleed-off is extracted from the closed loop and treated to comply with the regulations. Cleaned effluent can then be safely discharged overboard. It is also possible to operate the closed loop system in an effluent zero discharge mode, i.e., with no discharge overboard, as the water can be stored in a holding tank on board.

The closed loop system is independent on seawater alkalinity and is thus an option for vessels operating in waters with extremely low alkalinity. Generally, closed loop scrubbers are used in lakes, while open loop scrubbers are used on vessels sailing the big oceans.

The hybrid scrubber can be used both in open and closed loop modes, giving shipowners added flexibility as the vessel can operate in all four corners of the world.

“This added flexibility is also a benefit if the vessel is transferred to a new shipowner who wants the vessel to operate in a closed loop area”, notes Suopanki.

Wärtsilä’s scrubber systems are compact in size and can be easily retrofitted. With the proper planning and engineering, the installation can be done fairly quickly. The vessel is out of service for no more than a few weeks. In some cases the installation has even been done while the vessel was sailing. This is naturally only possible if the vessel has several engines to choose from for propulsion and electricity demand on board.

3. FEEDing high demand

The new regulations have the marine market witnessing an increased demand for environmental solutions for existing fleets. Exhaust gas cleaning systems and ballast water management solutions are the most common retrofits. Most of the existing ships have not been originally designed to accommodate these new products, so analysing the ship and engineering a concept for installation becomes a given first step. In the industry, people refer to this activity as FEED (Front End Engineering and Design).

FEED comprises ship inspections, modifications to general arrangement drawings, laser scanning and 3-D modelling, exhaust gas back pressure measurements and calculations, analysis of electrical demand and connections to the existing electrical network as well as analysis of integration to the existing automation system.

Wärtsilä Retrofit has performed FEED actions at an unprecedented pace during the last few years. The FEED can be done as part of a larger turnkey retrofit deal.

4. Conclusion

So complying with the legislation on sulphur oxides is not such a big deal after all. Still, a lot of shipowners are dragging their heels.

“Shipowners generally are not too well prepared in regards to the new legislation. Retrofitting scrubbers is a big investment for any shipowner. A lot of shipowners are choosing to wait and see what happens on the market before making this decision”, says Kullas-Nyman.

However, there are also shipowners that are taking actions. One of the latest shipowners to invest in Wärtsilä’s scrubbers is Finnlines, who after having first ordered scrubbers for six vessels in its Baltic and North Sea fleet, made a repeat order for three more vessels to make sure it complies with the new regulations.

Österdahl points out that big environmental gains at sea can be made with the huge passenger ferries, rather than smaller commercial vessels. *“There are some other Baltic Sea clients in the merchant segment who have switched to LNG, but installed power is much less on a merchant ship. The big impact on the environment is of course the ships that consume a lot of fuel. It has a much smaller impact on the environment when big ships are environmentally friendly”.* Whichever of these methods is chosen, it can be assured that the environment – and all of us, will benefit from that decision.

Russian innovative companies in marine engineering – Case: Seismo-Shelf Ltd

Nikita Lisitsyn

Industry of marine engineering emerged in Russia in the early 18th century. During the most of its history, it was mainly associated with shipbuilding alone. In the 20th century, development of global economy raised demand for mineral and other resources, and thus promoted a new industry of underwater investigations, both for scientific and commercial use. Underwater researches gained almost the same importance as space explorations, as for the humanity both the space and the World Ocean remained terra incognita for the entire previous period of history. The USSR, asserting its role in international affairs, was paying serious attention to underwater explorations, so its activities in oceanology reached global scale (as well as those of the USA and some other countries, e.g. France, Great Britain, Japan and Norway). For instance, Soviet research ships were carrying out scientific and commercial explorations in all the five oceans, but primarily in the Atlantic Ocean, in the Pacific Ocean and in the Arctic Ocean. This new sphere of investigation required new technical instruments. Some of those instruments were installed on board the ship (like shooters, radars and others), but some of technical appliances, especially for deep water zones, were submerged (such as research bathyscaphes). This technical experience, inherited from the Soviet past, laid the foundation for contemporary Russian subsea marine engineering¹.

Specialised marine engineering in Russia since Soviet times was concentrated mostly in seaport areas, but due to peripheral location of the Pacific Ocean, the Caspian Sea and the Black Sea seaports, the main cluster of this industry was formed in the North-West, namely in St. Petersburg and Murmansk. This was also a reflection of a role that St. Petersburg played as a scientific centre in oceanology, in the Arctic studies, and historically in shipbuilding.

In the past 30 years, the rising necessity for mineral resources, primarily for hydrocarbons, created a motivation for further development of marine exploration technologies. Use of marine drilling platforms in offshore zones of seas and oceans enabled extraction of mineral fuel from the technical side, while comparatively high oil prices created economical preconditions for these activities. Global energy industry and its infrastructure (marine drilling platforms, subsea pipelines and specialised vessels) became visible in the North Sea, in the Mexican Gulf and in many other waters all over the world. This created additional demand for subsea exploration, especially for sea bottom surveys, and, consequently, for new investigation tools. Among these tools were the so-called ocean bottom systems (OBS), from which the most important were ocean bottom nodes (OBNs). This gave a birth to a specific branch of marine engineering, namely marine seismic nodal engineering.

The first OBN appeared already in the 1970s, but at those times it was more a scientific tool. The wide use of these devices started approximately 15 years ago. OBNs appeared as a new technology for exploration of a sea bottom, primarily for offshore oil and gas projects. The OBN is a small device, placed on the sea bottom and recording seismic signals. Its main difference from previously used device, namely a streamer, is its autonomous operation (while streamers are attached to a survey vessel), on-bottom location (while

¹ Here the author deals with civil marine engineering alone, leaving a specific military sector behind.

streamers float along the water surface), more profound geological data recorded (due to multicomponent sensors). Because of its autonomy and ability for automatic resurfacing OBN is something between a marine onboard device and a subsea robot. The OBN survey technology is currently an innovative technology, not only resulting in a better geophysical data obtained from a survey, but also covering some unexplored water zones. For example, a so-called transit zone (a part of offshore with small depths) was not well explored before, as vessels could not operate in shallow waters, and vessel-based equipment became useless in those areas (contrary to autonomous OBNs). The scheme of the OBN technology is presented below.

Picture 1. Scheme of the OBN technology

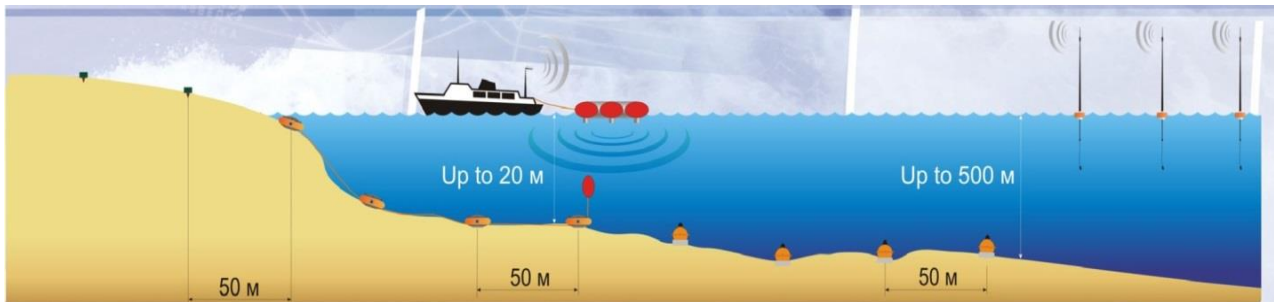

Source: Seismo-Shelf Ltd.

The OBN technology, being useful and competitive, became not only a substitute for the previously used one (i.e. streamer technology), but a new trend in marine seismic exploration, so-called 'nodal seismic'. And it was from a very beginning 'monopolised' by a limited number of pioneering companies, which developed OBNs and launched services, based on use of these innovative devices. Those companies were Fairfield Nodal (the USA), Geospace Technologies (the USA) and Seabed Geosolutions (the USA).

Seismo-Shelf Ltd. was established in St. Petersburg, Russia in late 2009 as a start-up in OBN seismic survey and production. The company started to develop this new generation of marine devices almost at the same time as Fairfield, which is a global leader in this field. As a result, the basic model of Seismo-Shelf OBN is very similar to that of Fairfield Nodal (see Picture 2).

Picture 2. Ocean Bottom Nodes: main producers



Source: Seismo-Shelf Ltd.

BSR Policy Briefing 1/2016

The company started its R&D activities in 2010, and by 2013 created a park of OBNs needed to enter the market of marine seismic surveys. Two-stage investment round enabled Seismo-Shelf to get the necessary funding. By the way, it was one of the first examples among Russian technological start-ups getting investment in a form of venture capital, and this deserves special attention.

In 2009, the Russian Government decided to launch a sustainable system of venture funding that could later give impact for the national economy's diversification. The first step was establishment of a state-owned venture agency called Russian Venture Company (RVC). This was needed to create an access of potential venture investors to cheap state funding. Second step was conducting a number of tenders, where financial investors (mostly asset management companies, namely Allianz Investment, Sberbank Capital, VTB, et cetera) could get this funding in order to invest it into small technological start-ups. Later the financial investors had to manage the new venture projects involving the above-mentioned start-ups until they turn into sustainable and quickly growing technological businesses. This way Seismo-Shelf got venture funding from state-supported RVC programme, while managing investors were two big financial companies (Allianz Investment and Leader Innovation).

The company's development in 2010-2015 was a combination of permanent R&D activities, test works with new equipment in key areas (in the Baltic Sea, the Barents Sea and the Caspian Sea) and doing commercial surveys for the marine oil and gas operators (in the Kara Sea). However, conditions of this market initially were quite unfavourable for Seismo-Shelf. The reason was strong competition from global producers of the ocean bottom nodes. Under comparatively high value of national currency (Rouble) in 2011-2013, the price of Russian-made OBN was higher, than the price of OBN produced by US-based Fairfield, which enjoyed the economies of scale and had financial leverages for global dumping. Moreover, big local operators of offshore projects (Rosgeo, MAGE, Yuzhmorego, et cetera) were purchasing imported nodes from US suppliers (Fairfield and Geospace) at very attractive conditions of low-interest commercial credits, low-interest leasing et cetera. Seismo-Shelf had no opportunity to compete in this field, as Russian financial system does not supply same supportive financial instruments for domestic producers as US banking system does. So despite proven high technical parameters of its OBNs, the market was dominated by foreign technological companies.

Crisis on the oil market in late 2014 had a negative impact on Seismo-Shelf, as marine offshore operators started to cancel new projects. Production cycle in marine seismic survey industry is long, so the crisis in this sector became visible in 2015.

Nevertheless, some of external shocks of past 2 years appeared to be quite positive for the company. First, sharp devaluation of national currency (Rouble) led to lower USD price for the Russian-made OBN and diminished USD-measured internal costs for the company, first of all labour costs. Export projects with OBN services became more attractive due to bigger margin caused by higher USD value measured in Roubles. This refers to all Russian exporters, but businesses exporting value added goods or services had much better performance than big raw exporters, whose USD-measured sales shrunk due to commodity price reduction.

Figure 1. Crude oil: Brent, USD per barrel

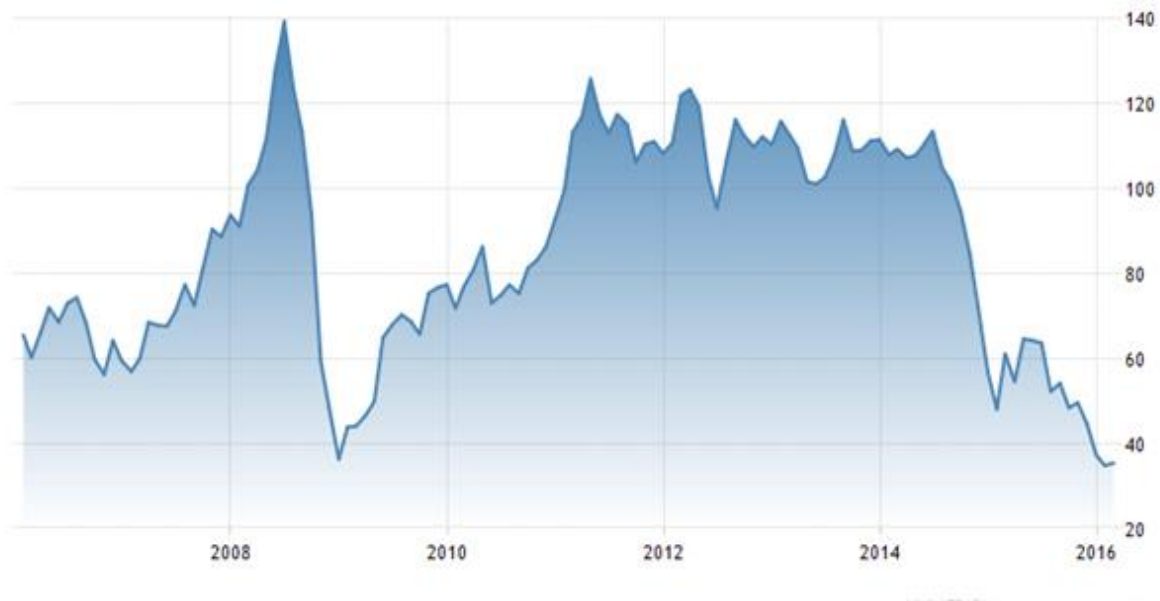

Source: www.tradingeconomics.com

Second, in July 2014 the USA introduced so-called sectoral sanctions on Russian energy companies, including JSC Rosneft, which was the biggest consumer of marine subsea exploration services (OBN services included)². According to Directive 4 of OFAC³, since July 2014 until present time US companies are restricted to supply any goods, services and/or technologies for marine oil exploration and extraction (with special focus on the Arctic Ocean) to certain Russian companies, including JSC Rosneft and all its daughter companies (e.g., Rosneft-Shelf-Arctic, the biggest offshore operator in the Russian Arctic waters, Rosneft-Shelf-Far East). This decision of US authorities brought radical changes to the market of marine OBN devices. The main players, namely US companies, such as Fairfield Nodal, Geospace or Seabed lost their access to one of the biggest markets, namely to Russia's market of marine subsea explorations. After 1.5 years, we can confirm, that these sanctions are carefully observed by the US-based producers of this innovative marine equipment.

The abovementioned change had direct influence on Seismo-Shelf and its business. Suddenly, the market niche expanded, while there were (and still are) no domestic competitors. Of course, some of the imported OBN equipment earlier acquired by Russian offshore operators is still functioning, but it has short lifetime, and any imports of OBNs became unavailable since mid-2014. In this situation, offshore operators started to investigate opportunities of producing OBNs and related technologies inside Russia, while Seismo-Shelf offered its solutions for this problem. Today the company is finalising a large-scale programme of domestic OBN production and exploiting for both state and private investors.

² US Department of the Treasury, Office of Foreign Assets Control (OFAC), Sectoral Sanctions Identification List, last updated on Dec 22, 2015; available at: https://www.treasury.gov/resource-center/sanctions/SDN-List/Pages/ssi_list.aspx

³ Abbr.: US Office of Foreign Assets Control, OFAC.

This unique phenomenon when a small local innovative company expands business due to sudden emergence of cross-border technological barrier could be called externally induced protectionism. It reminds us of Soviet technological autarky under CoCom⁴ limitations and internal over-protectionism. If this model of technological co-operation (or co-existence) remains stable in mid- or long-run, this might lead to creation of new domestic innovative enterprises, which are sometimes creating brand new products and technologies, but sometimes just duplicating Western technologies in this framework of import substitution. For example, in the Soviet Union there have been 24 enterprises producing geophysical equipment (including that for marine surveys), and up to 2014 only a handful of those remained active under the pressure of global competition. By the way, for the consumer that period was 'a golden age' as Western producers offered better technical and financial solutions than those of domestic producers. From a strategic viewpoint, this phenomenon of quasi-protectionism could be good for national economy in mid-term, but would create 'greenhouse effect' for local producers of specialised marine equipment in a long-term, leading these producers to low effectiveness and incompetitiveness.

Thus case of Seismo-Shelf not only illustrates an example of a small innovative company, but also rises up certain theoretical issues of a changing business environment in marine engineering.

⁴ Abbr.: Committee for Control of the Export of Strategic Commodities (CoCom), a regulative body created by NATO countries and Japan in 1949 to prevent technological exports to USSR and other socialist countries.

Baltic Sea ports – A recent picture and an overview of selected challenges

Bogdan Ołdakowski

Executive summary

This article presents an overview of the Baltic Sea ports market and gives some insight to the role of ports in EU transport policy. It also points out some trends and challenges ahead of Baltic Sea ports, including a concentration of the port market, the future of medium-sized ports, compliance with a new environmental regulation regime.

The total cargo volume in 2014 in Baltic Sea ports reached a level of 870 million tonnes. The total 2010-2014 growth depended 80% on the increases taking place on the shore of Russia, particularly in the Gulf of Finland. Russia has been at the top of the total port handlings table since 2011, also leading in liquids and dry bulk handlings.

As of January 2014, the European Union has a new transport infrastructure policy (TEN-T Policy). The aim of the new policy is to transform the existing patchwork of European roads, railways, airports and canals into a unified transport network. The new policy assumes that a TEN-T network will be developed gradually by implementing a dual-layer approach. This means that two layers of TEN-T networks are established: a comprehensive network and core network. Both layers include all transport modes: road, rail, inland waterways, air and maritime transport, as well as intermodal platforms.

Within the core network, nine corridors have been established. Among these nine corridors, four of them are crossing or attached to the Baltic Sea Region: Baltic-Adriatic Corridor, North Sea-Baltic Sea Corridor, Scandinavian-Mediterranean Corridor and Orient/East-Med Corridor. Within the Baltic Sea region, there are 22 ports included in the TEN-T core network and 76 comprehensive ports.

Since January 1st 2015, stricter limits have become a fact and since then ships operating in the SECA (North Sea, the English Channel and the Baltic Sea) should not use marine fuels with a sulphur content exceeding 0.1% by mass. It created a new situation for maritime transport as whole in the Baltic Sea. The Baltic Port Organization (BPO) has been taking and pro-active role when it comes to planning and deploying the infrastructure for LNG bunkering in the Baltic Sea ports. The BPO has initiated and run two project called LNG in the Baltic Sea Ports (I & II), which focused on harmonised development of infrastructure for LNG bunkering, totally in 11 Baltic Sea ports.

So far, due to a decrease of oil price in last two years, the impact of the new sulphur limits on freight rates is limited. However, it may happen that the impact of sulphur directive on freight rates will be more visible in the future (if the fuel prices will increase and the difference between IFO and MGO will deepen).

There are several challenges ahead of Baltic Sea ports. Russia has been and remains to be the main market for many Baltic Sea ports. Recent EU-Russia political relations, the low price of oil and other commodities, as well as a lack of economic reform do not let us see a bright future in returning back to trade volumes

from a few years ago. Therefore, Baltic Sea ports – those involved in business with the Russian market – should adopt to lower volumes.

In a long term, a concentration of cargo transshipment in larger ports may occur caused by the fact that larger ports (those having core status) have a better access to financing port infrastructure and have a priority status in the transport policy. Thus these ports have preferable conditions to upgrade their infrastructure faster than medium-sized ports. Moreover, there is a general trend in shipping that ships are getting larger as a response to market demand. Larger ships will call fewer ports and concentrate their cargo volumes in larger, deeper ports, which further stimulates the concentration trend in the port market.

Environmental regulations, which are being introduced in the Baltic Sea, have a direct impact on maritime transport and ports, e.g. obligatory delivery of sewage from passenger ships at ports, introduction of new limit for NOx emission. The BPO supports policy aimed at a clean Baltic Sea, but is also of the opinion that a balanced way of complying with implementing this policy and new regulations has to be found. All of these environmental regulations have their unquestioned overall goal to protect the Baltic Sea's environment but there are specific Baltic Sea regions, which differ from other regions in the EU. Thus, having different regulations in one part of Europe than in another part creates an unfair market situation, which is against a level playing field in all of Europe and imposes a distortion of competition.

1. Introduction

Ports are reflecting trade and economic development of their hinterlands – it is a simple truth. Baltic Sea ports in total handle about 850-900 million tonnes of cargo annually. Ports associated in the BPO represent quite a large portion of the market in the Baltic Sea. In the best years, Baltic Sea ports handled almost 10 million containers (measured in TEU, twenty-foot equivalent units), but in the 2015 year the number of containers was much lower (about a 25% decrease) due to the weakened Russian economy and a drop in consumption. Trade between the Baltic Sea region countries as well as the movement of people has been rather stable over the last years and does not variate much, except trading with Russia and to some extent in Finland in the last years. There are lots of Russian natural resources being exported via Russian ports (mainly Ust-Luga and Primorsk) but also via ports in Latvia and Lithuania. All in all, it makes Baltic Sea ports quite busy but more recently a wide range of them are being affected by the recession in Russia (Figure 1).

Ports are part of the whole transport infrastructure and they play an important role in the EU's Transport Policy. The policy identifies so-called core networks (9 transport corridors, roads, railways, larger ports and airports) and comprehensive networks (including secondary transport infrastructure, smaller ports). There are 22 core Baltic Sea ports (almost all of them are part of the corridors) and around 75 comprehensive ports. One of the main differences between being classified as a core or a comprehensive port is access to financial development projects from the Connecting Europe Facility (CEF) – the EU fund granting money to co-finance transport infrastructure projects. Since the Baltic Sea port market is fragmented (many medium-sized and smaller ports), a large portion of the ports has more difficult access to CEF money, which might be considered as a barrier to their development.

Figure 1. Ports associated in the Baltic Sea ports



Source: Baltic Ports Organization (2016).

On one hand, ports are commercial entities responsible for handling cargo and passengers and creating added value. On the other hand, ports are public entities providing infrastructure for use of other entities, responsible for development responding to future market demand as well as responsible for complying with related regulations.

2. The Baltic Sea port market

Recently, the Baltic Transport Journal published a comprehensive report entitled the Baltic Ports Yearbook 2014/2015 describing the port market with market statistics and trends (Baltic Transport Journal 2015b). According to this publication, the total cargo volume in 2014 in Baltic Sea ports reached a level of 870 million tonnes, which was a 3.4% year-on-year increase. The total 2010-2014 growth depended 80% on the increases taking place on the shore of Russia, particularly in the Gulf of Finland. Russia has been at the top of the total port handlings table since 2011, also leading in liquids and dry bulk handlings (the former as of 2013). Sweden, the dethroned leader in totals, is still at the top of the general cargo chart. Talking about particular seaports, the total freight turnover winners' podium is occupied by three Russian enterprises. This means that a cluster of five Russian harbours, located in the Gulf of Finland's

easternmost corner, handled altogether 210 million tonnes in 2014, estimated at 24% of the Baltic Sea total.

All cargo categories of the Russian Baltic Sea ports grew by over 50% in 2005-2014 (Table 1). Despite the rapid development of infrastructure around St. Petersburg, there is still enough room for growth to cater other eastern harbours serving Russian transit traffic (or even more widely, the needs of the Commonwealth of Independent States, the CIS). The last decade's exceptional increases in Lithuanian (+57%) and Latvian (+24%) port turnovers is due to freight coming from their continental hinterland (Belarus and Ukraine). Also, the Estonian Port of Sillamäe (which opened in 2005, shortly after its closest neighbour, Ust-Luga) rose from zero to 7.5 million tonnes last year, again, thanks to Russian cargo. Estonian harbours are the only ones across the eastern Baltic Sea shores whose throughputs contracted, most probably due to competition from the side of Ust-Luga (e.g. Tallinn's terminals lost its entire coal turnover which back in 2006 accounted for 7.5 million tonnes). Russia's freight hunger also stands behind Gdańsk's container success as well as the port's crude oil failure (in the latter case to a certain degree, naturally). The Port of Gdańsk lost its market of crude oil transit, but in return gained the ocean liners-feeders transshipment, delivering containers to wide gauge rail network-connected facilities.

Table 1. Total volume of the Baltic Sea ports by country

Country	2005 [mln tn]	2010 [mln tn]	2013 [mln tn]	2014 [mln tn]	2005-2014 [%]	2013-2014 [%]
Russia	141.4	177.1	215.7	223.5	+58.1%	+3.6%
Sweden	178.1	179.6	161.6	166.8	-6.3%	+3.2%
Finland	100.3	108.2	106.1	104.7	+4.6%	-1.3%
Denmark	100.2	87.2	88.3	92.4	-7.8%	+4.6%
Latvia	60.0	61.3	70.5	74.2	+23.7%	+5.2%
Poland	54.8	59.5	64.3	68.9	+25.7%	+7.2%
Germany	52.4	54.8	51.9	53.1	+1.3%	+2.3%
Lithuania	27.8	40.3	42.4	43.7	+57.2%	+3.1%
Estonia	47.1	46.1	42.9	43.6	-7.4%	+1.6%
Total	762.1	814.1	843.7	870.9	+14.3%	+3.2%

Source: Baltic Transport Journal (2015a).

Accordingly, almost all top Baltic Sea ports are those located in Russia or servicing the Russian market. In the top 10, there are also other ports, such as Gothenburg, the largest Swedish ports, Klaipėda and Gdańsk (Table 2).

Table 2. Top 20 Baltic Sea ports by volume

No.	Country	Port	2005 [mln tn]	2010 [mln tn]	2013 [mln tn]	2014 [mln tn]	2005-2014 [%]	2013-2014 [%]
1	RU	Ust-Luga	0.7	11.8	62.6	75.7	x108	+20.9%
2	RU	St. Petersburg	57.5	58.1	58.0	61.2	+6.4%	+5.5%
3	RU	Primorsk	57.3	77.6	63.8	53.7	-6.3%	-15.8%
4	LV	Riga	24.4	30.5	35.5	41.1	+68.4%	+15.8%
5	SE	Gothenburg	37.1	44.4	38.9	37.1	+/-0.0%	-4.6%
6	LT	Klaipėda	21.8	31.3	33.4	36.4	+67.0%	+9.0%
7	PL	Gdańsk	22.5	26.4	27.3	29.2	+29.8%	+7.0%
8	EE	Tallinn	39.5	36.6	28.2	28.3	-28.4%	+0.4%
9	LV	Ventspils	29.9	24.8	28.8	26.3	-12.0%	-8.7%
10	FI	Sköldvik	17.4	20.5	23.1	22.4	+28.7%	-3.0%
11	PL	Szczecin-Świnoujście	18.6	18.7	19.9	21.4	+15.1%	+7.5%
12	SE	Brofjorden	19.2	20.5	16.5	21.3	+10.9%	+29.1%
13	DE	Rostock	17.1	19.5	17.8	19.5	+14.0%	+9.6%
14	RU	Vysotsk	10.4	14.8	16.2	17.4	+67.3%	+7.4%
15	DE	Lübeck	18.8	17.9	17.0	17.2	-8.5%	+1.2%
16	PL	Gdynia	11.0	12.3	15.1	16.2	+47.3%	+7.3%
17	RU	Kaliningrad	14.6	13.8	13.7	13.9	-4.8%	+1.5%
18	DK/SE	Copenhagen Malmö Port (CMP)	13.2	15.5	14.6	13.4	+1.5%	-8.2%
19	FI	HaminaKotka ¹	13.7	15.8	14.0	13.4	-2.2%	-4.3%
20	FI	Helsinki	11.0	10.9	10.5	10.8	-1.8%	+2.9%
21	SE	Trelleborg	10.7	10.8	9.9	10.1	-5.6%	+2.0%
22	DK	Fredericia (ADP)	17.6	13.6	11.1	9.8	-44.3%	-11.7%
23	FI	Kokkola	4.1	6.3	7.8	8.6	+110%	+10.3%
24	SE	Stockholm	8.3	8.0	8.0	7.9	-4.8%	-1.3%
25	SE	Helsingborg	7.0	7.4	7.4	7.8	+11.4%	+5.4%
26	DK	Aarhus	11.2	9.4	8.1	7.6	-32.1%	-6.2%
27	EE	Sillamäe	0.5	3.5	6.7	7.5	x15	+11.9%
28	SE	Luleå	7.7	9.3	8.0	7.5	-2.6%	-6.3%
29	LT	Būtingė	6.1	8.9	9.0	7.3	+19.7%	-18.9%
30	DK	Statoil-havnen	7.8	7.0	7.4	7.1	-9.0%	-4.1%
		Total	536.7	605.9	638.3	657.1	+22.4%	+2.9%

Source: Baltic Transport Journal (2015a).

3. European transport policy and role of ports

As of January 2014, the European Union has a new transport infrastructure policy that connects the continent between East and West, North and South. According to the European Commission, the policy should help the economy in its recovery and growth, with a budget of € 26 billion up to 2020.

The aim of the new policy is to transform the existing patchwork of European roads, railways, airports and canals into a unified transport network (TEN-T). The trans-European transport network is a network which comprises roads, railway lines, inland waterways, inland and maritime ports, airports and rail-road

terminals throughout the 28 Member States. The new policy assumes that a TEN-T network will be developed gradually by implementing a dual-layer approach. This means that two layers of TEN-T networks are established: a comprehensive network and core network. Both layers include all transport modes: road, rail, inland waterways, air and maritime transport, as well as intermodal platforms (Baltic Ports Organization 2014).

The comprehensive network is a multi-modal network of relatively high density, which provides all European regions (including the peripheral and outermost regions) with accessibility that supports their further economic, social and territorial development as well as the mobility of their citizens. Its planning has been based on a number of common criteria (e.g. volume thresholds for terminals or accessibility needs). The complete comprehensive network is planned to be in place by 31 December 2050 at the latest.

The core network overlays the comprehensive network and consists of the most important parts of the TEN-T network strategically. It constitutes the backbone of the development of a multimodal transport network. It concentrates on those components of TEN-T with the highest European added value: missing cross-border links, key bottlenecks and multimodal nodes. The core network is planned to be completed by 31 December 2030 at the latest. It shall, in particular, contribute to coping with increasing mobility and ensure a high safety standard as well as contribute to the development of a low-carbon transport system. The core network shall be interconnected in nodes and provide for connections between Member States and with neighbouring countries' transport infrastructure networks. There are 93 seaports and 79 inland ports included in the core network.

Within the core network, nine corridors have been established (see Figure 2). Core network corridors cover the most important long-distance flows in the core network and are intended, in particular, to improve cross-border links within the EU. Core network corridors shall be multimodal and open to the inclusion of all transport modes. They cross at least two borders and and, if possible, involve at least three transport modes, including, where appropriate, Motorways of the Sea.

Figure 2. Nine multimodal corridors in the European Union



Source: European Commission (2014).

BSR Policy Briefing 1/2016

Core network corridors should facilitate modal integration and interoperability and lead to co-ordinated development and management of infrastructure. Multimodal infrastructure within core network corridors shall be built and co-ordinated, wherever needed, in a way that optimises the use of each transport mode and its co-operation. The core network corridors shall support the comprehensive deployment of interoperable traffic management systems.

Among nine corridors, four of them are crossing or attached to the Baltic Sea region:

- Baltic-Adriatic Corridor,
- North Sea-Baltic Sea Corridor,
- Scandinavian-Mediterranean Corridor, and
- Orient/East-Med Corridor.

In the European Commission's new strategy for the European transport network, seaports constitute a strategic access point for multimodal networks. Together with other nodal points, such as inland ports and airports, seaports are put in a central position of the Trans European Transport Network. Seaports have a vital role to play within the TEN-T, by increasing the efficiency of the whole European transport system. Seaports together with adequate infrastructure connections are vital for the European industry and inland and external trade development. Furthermore, seaports' good connections with rail and road infrastructure can contribute to eliminating bottlenecks along the main transport corridors. Seaports, as a connection point for the shipment of goods and passengers between land and maritime means of transport, also play a crucial role in the development of intermodal transport, which is an essential component of a common policy on sustainable mobility. They have been divided into two categories: core (larger) and comprehensive (smaller) ports.

The new European Union policy aims at the sustainable development of European seaports by promoting industry efficiency, reducing the negative impact on the environment and integrating seaports within the entire chain of transports.

The new TEN-T policy includes 93 seaports in the core network, which handle approximately 73% of cargo passing through all EU seaports. The greatest number of core seaports (31) is concentrated within the Mediterranean Sea region. Along the UK and Irish coast 16 seaports/group of seaports are included in the TEN-T core network (3 in Ireland and 13 in the UK). In the North West Continent region, which covers the North Sea part of Germany, the Netherlands, Belgium, the North Sea part of France, core seaports are distributed quite equally. Along the EU-Atlantic coast, 10 seaports are included in the TEN-T core network.

Within the Baltic Sea region, there are 22 ports included in the TEN-T core network: two Danish ports (Aarhus and Copenhagen), two German ports (Lübeck and Rostock), one Estonian port (Tallinn), two Latvian ports (Riga and Ventspils), one Lithuanian port (Klaipėda), four Polish ports (Gdańsk, Gdynia, Szczecin and Świnoujście), five Finnish (Hamina, Helsinki, Kotka, Naantali and Turku), and five Swedish ports (Gothenburg, Luleå, Malmö, Stockholm and Trelleborg). However, among these ports, there are three pairs of ports which are under a single port authority: Copenhagen-Malmö in Sweden/Denmark, Kotka-Hamina in Finland and Szczecin-Świnoujście in Poland.

Baltic Sea seaports included in the TEN-T core network are the largest ports in the region with the most dense liner service (container, ro-ro and ferry). However, some EU Baltic Sea seaports that handle more

BSR Policy Briefing 1/2016

than 10 million tonnes of cargo are not included in the core network. These are Brofjorden and Sköldvik (which only handle liquid cargo) and Fredericia. Together the Baltic Sea core ports handled 337.5 million tonnes of cargo, which constitutes 53.3% of the EU Baltic Sea seaports' total turnover, and about 40.2% of the total Baltic Sea seaports' throughput, including Russia.

In addition to the core ports, there are 76 Baltic Sea ports that are included in the comprehensive network. The list of comprehensive Baltic Sea ports includes 20 Danish ports, 20 Swedish ports, 15 German ports, 12 Finnish ports, 7 Estonian ports, one Polish port and one Latvian port (Table 3).

Table 3. List of Baltic Sea comprehensive ports

	Denmark	Germany	Estonia	Latvia	Lithuania	Poland	Finland	Sweden
1	Aalborg	Bensersiel	Heltermaa	Liepaja	-	Police	Eckero	Gavle
2	Branden	Brake	Kuivastu				Hanko	Grisslehamn
3	Ebeltoft	Brunsbüttel	Parnu				Kaskinen	Halmstad
4	Esbjerg	Cuxhaven	Paldiski South Harbor				Kemi	Helsingborg
5	Fredericia	Emden	Rohukula				Skoldvik	Kapellskar
6	Frederikshavn	Helgoland	Sillamae				Kokkola	Karlshamn
7	Fur	Kiel	Virtsu				Maarianhamina	Karlskrona
8	Gedser	Langeoog					Oulu	Koeping
9	Helsingør	Norddeich					Pietarsaari	Norrköping
10	Hirtshals	Nordenham					Pori	Oskarshamn
11	Kalundborg	Norderney					Rauma	Oxelosund
12	Køge	Puttgarden					Rautaruuki/Raahel	Stenungsund
13	Nordby	Sassnitz						Nynashamn
14	Odense	Stade-Butzfleth/ Brunshausen						Stromstad
15	Rødby	Wismar						Sundsvall
16	Rønne							Umea
17	Sjællands Odde Ferry Port							Verberg
18	Spodsbjerg							Vasteras
19	Tårs(Nakskov)							Visby
20	Vejle							Ystad

Source: Baltic Ports Organization (2014).

Following the new TEN-T Policy, so-called Connecting Europe Facility has been established. CEF is a financial tool for investing in transport, energy and ICT infrastructure proposed and approved by the European Commission for the budgetary period 2014-2020. For the first time, the Commission has proposed a single funding instrument for the three network sectors in the framework of the Regulation (EU) No. 1316/2013 of the European Parliament and of the Council of 11 December 2013 establishing the Connecting Europe Facility. The aim of the creation of the Connecting Europe Facility is to accelerate investment in the field of trans-European networks and to leverage funding from both the public and private sectors.

BSR Policy Briefing 1/2016

The estimated investment requirements for trans-European networks in the transport, telecommunications and energy sectors for a period up to 2020 is about € 970,000 million. The CEF financial envelope for the period 2014 to 2020 could be estimated at a level of € 33.2 billion so the CEF constitutes about 3.4% of the total spending needed to complete the actions planned until the year 2020. So, further engagement of the Member States and the private sector is necessary to establish the TEN-T.

In the transport part of the CEF, € 11.3 billion has been transferred from the transport sections of the Cohesion Fund. This indicative amount will be available for cohesion countries, so in the Baltic Sea region the budget will be distributed among Estonia, Latvia, Lithuania and Poland. It should also be emphasised that until 31 December 2016 the selection of the eligible projects for financing shall respect the national allocations under the Cohesion Fund (the so-called national envelopes) and from 1 January 2017, the rest of the resources shall be made available to all Member States eligible for CEF funding (the general envelope for cohesion countries).

4. SECA – a smooth implementation

Since January 1st 2015, stricter limits have become a fact and since then ships operating in the SECA (North Sea, the English Channel and the Baltic Sea) should not use marine fuels with a sulphur content exceeding 0.1% by mass. It created a new situation for maritime transport as whole in the Baltic Sea, especially for shipowners and shipping lines, who had to transpose the cost (capital and operational) associated with the change into the prices for providing the services (Baltic Ports Organization 2015).

Monitoring the compliance of the SECA rules is one of the key issue in enforcement process. European Maritime Safety Agency (EMSA) is a competent body to gather the results from inspections on-board of ships while there are in EU ports. Inspections, including those checking sulphur content in marine fuels should be reported in THETIS-S (the Hybrid European Targeting and Inspection System).

According to data from THETIS-S, since the beginning of 2015 until March 12th 2015, 676 sulphur inspections have been carried out within the European Union. Most of them (512) took place within European SECA areas, i.e. on the North Sea and the Baltic Sea (Figure 3). In the whole EU, almost 6% of the total number of inspections revealed non-compliance. The largest number of non-compliance was found in the North Sea region. 28 out of 216 inspections indicated non-compliance with the provisions, i.e. this constitutes 13% of the total inspections within the North Sea. In 15 non-compliant cases, a penalty was applied. 12 non-compliances were identified during ship log book inspections, two during samples of fuels used and one during a bunker delivery note inspection. Within the Baltic Sea region, five inspections indicated non-compliance, which constitutes 1.7% of the total number of inspections. In three cases, a penalty was applied.

Figure 3. Inspections with non-compliance where a penalty was applied (from January 1st to March 12th, 2015)

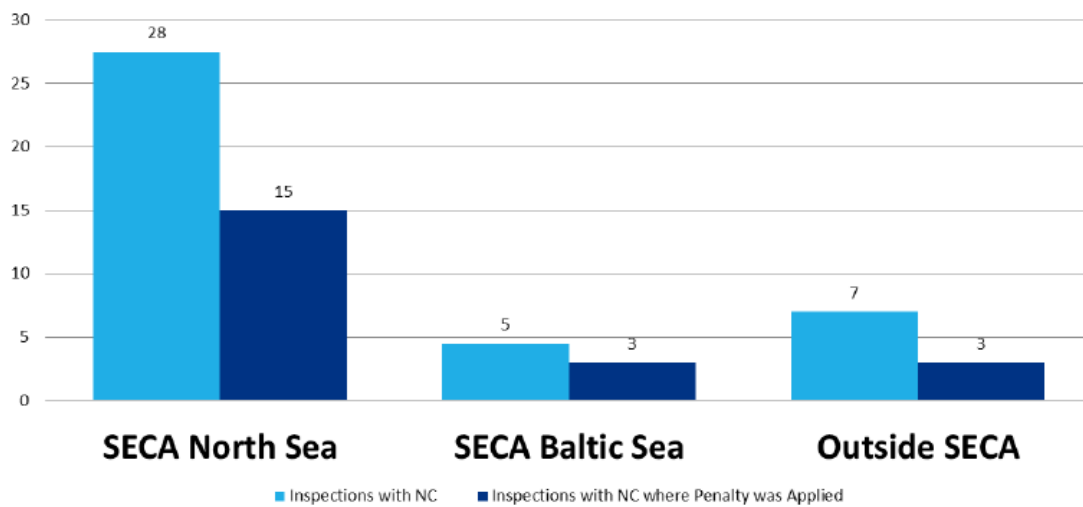

Source: Baltic Ports Organization (2015).

When it comes to compliance strategies, currently, three solutions exist in order to meet the new requirements. The first one is to switch to Marine Gas Oil (MGO) of a sulphur content not higher than 0.1% per mass instead of Intermediate Fuel Oil (IFO). This solution is now the most common option as it is the easiest one to introduce. The second one is to install scrubbers. And the third one is to use alternative fuels with a low sulphur content, of which currently the most popular one is liquefied natural gas (LNG). All of these solutions generate different costs for shipowners, so the option choice depends on each shipowner's economic calculation. What is regarded the best for one ship-owner may not necessarily be the best for another. In this chapter, there is an overview of how shipowners are meeting the new requirements.

Bunker fuel prices are a very important issue in the context of implementing the Sulphur Directive, as low sulphur fuels (MGO and MDO, Marine Diesel Oil) have always been more expensive than fuels with a higher sulphur content (IFO). This, usually high difference, significantly increases the cost of a ship's voyage, which constitutes a very important part of a total ship's running costs. Depending on the ship's type and size, fuel costs may account for about 58-78% of a ship's total running costs. Such a share means that even a few percent changes in fuel costs can have a significant impact on the total running cost of a vessel.

Generally, for a dozen or so years, distillate fuels (MDO, MGO) were on average 30-50% more expensive than IFO. In absolute terms, the difference has been changing, as ship fuel prices have been characterised by large fluctuations. At the beginning of the past decade, the price of bunker fuel was rather low. IFO cost around \$ 150-200, while MGO around \$ 200-300, so the absolute difference per tonne between residual fuels and distillates was at around \$ 50-100. After that period, the price of oil started to grow. As the price of bunker fuels increased, the difference deepened at first to \$ 200-300 and then reached its peak in 2008 (\$ 500-600), when MGO cost approximately \$ 1,300 per tonne and the price of IFO was almost at a level of \$ 700 per tonne. At the end of 2008, there was a sharp decrease in fuel prices, and for the next two years an increasing tendency was visible. Fuel prices more or less stabilised in 2011 at

relatively high levels at around \$ 600 per metric tonne for IFO and above \$ 900 per tonne of MGO. This means that the difference was around \$ 300 per tonne, or MGO was 50% more expensive than IFO.

The situation on the bunker market started to change in the second half of 2014, when prices began drifting down significantly. This was related to the dramatic drop in oil prices across the globe due to weaker demand and increased supply. Given that fuel is the single largest operating cost for shipping lines, the significant crash of oil prices means that shipowners have not suffered severely from the stricter sulphur regulations yet. The fuel prices declined to such levels that the cost of transport of containers in the SECA region increased below the assumed values or even decreased. On European feeder routes, costs are even lower than last year. For example, the cost of transport on the route Rotterdam-Dublin-Belfast declined by about \$ 16/TEU, whilst an increase of \$ 10 /TEU was expected.

When it comes to scrubber solution, presently, there are more than 200 confirmed projects worldwide, the majority (around 2/3) of these are retrofit projects. By the end of 2014, scrubbers had been installed on-board around 75 ships and, according to an estimation by the end of 2015, over 160 ships will be equipped with scrubbers. Scrubbers are mainly installed on cruise ships, ferries and ro-ro ships.

Table 4 presents selected Baltic Sea and North Sea ro-pax and ro-ro operators that have invested in scrubbers. The total fleet of selected operators amounts to 152 ships. 44 ships are already equipped with scrubbers, while 17 are scheduled to be retrofitted in 2015 and 2016. This means a total of about 40% of the analysed fleet will be using scrubbers.

Table 4. Selected Baltic Sea and North Sea ro-pax and ro-ro ship operators that have invested in scrubbers (as of March 2015)

Ship operator	Already installed	Planned in 2015 / 2016	Planned and installed (% of total fleet)
DFDS	11	10	46%
Finnlines	14		63%
Transfennica	6		40%
Color Line	4		66%
Scandlines	4	2	54%
Brittany Ferries	3	3	85%
TT-Line	1		16%
TransAtlantic	1		25%
Stena Line		2	6%
Total	44	17	40%

Source: Baltic Ports Organization (2015).

In terms of number of ships, the largest investment in scrubbers has so far been announced by DFDS Seaways – one of the biggest Northern European ro-ro and ro-pax ship operators. DFDS decided to invest € 100 million in scrubbers on 21 vessels out of around 45 of its ships. Some installations are already finished, some are ongoing and some are planned. Generally, the whole investment is scheduled to be completed in 2016. An additional six DFDS vessels were fitted with scrubbers in 2015. Each scrubber installation costs around € 4-7 million.

BSR Policy Briefing 1/2016

A large investment in scrubbers was recently carried out by Finnlines as well. According to the operator's information, 14 out of 21 of its vessels are going to use scrubbers. Other vessels will use MGO fuel which contains less sulphur. Finnlines started to retrofit its ships at the end of 2014, and the whole investment ended in early 2015. The total investment is estimated at € 50 million, € 20.3 million came from Finland's initiative to support solutions aimed at combating consequences of the 2015 Sulphur Directive.

Six out of Transfennica's 15 operating vessels were using scrubbers already, the rest of the vessels were burning low-sulphur fuels. Scandlines aims to equip 50% of its fleet with scrubbers. By 2015, Scandlines invested some € 14 million in scrubber solutions. Apart from retrofitting its existing ships, Scandlines ordered two new ships for its Rostock-Gedser route, which will use a hybrid propulsion system combined with a scrubber. Swedish ferry operator Stena Line retrofitted two of its ro-ro vessels with Wärtsilä's in-line closed-loop scrubber systems. The German-Swedish ferry operator TT-Line installed a hybrid scrubber system on its ro-pax vessel Robin Hood, sailing on its Travemünde-Trelleborg link.

Another alternative way to comply with sulphur limits is to use LNG fuel. As of March 2015, there were 138 confirmed LNG-fuelled ship projects worldwide (60 LNG-fuelled ships in operation and 78 ships under construction/refitting) (Figure 4). Still over 80% of all LNG-fuelled vessels in operation are only sailing in Norwegian waters and mainly represent small ships, such as small car/passenger ferries, offshore ships (PSV, Platform Supply Vessel), petrol vessels, and tugs. However, now there are also several larger vessels powered by LNG in operation, such as large ro-ro and ro-pax vessels, general cargo vessels, gas carriers, excluding LNG carriers.

Figure 4. LNG-fuelled fleet in operation and ordered worldwide (as of March 2015)

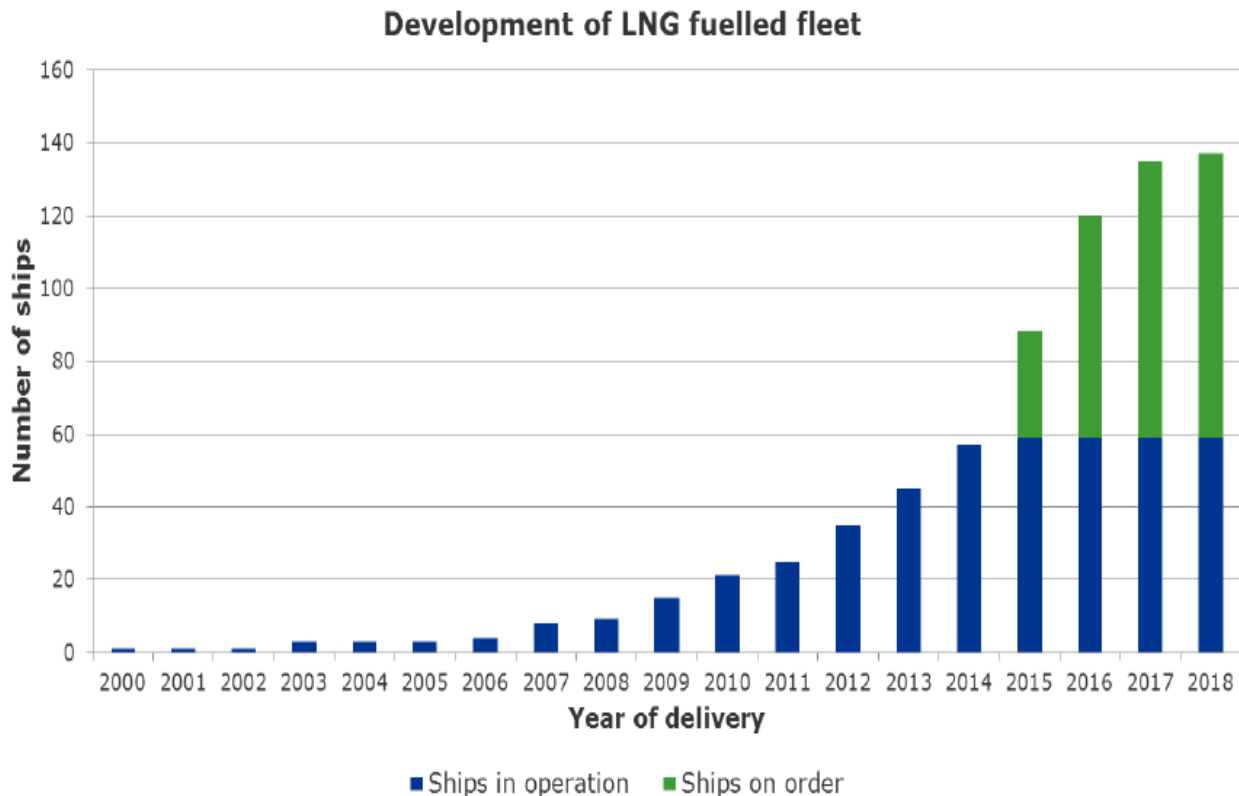

Updated 10.03.2015
Excluding LNG carriers and inland waterway vessels

Source: DNV GL (2015).

BSR Policy Briefing 1/2016

There is one LNG-fuelled ship operating recently in the Baltic Sea (Viking Grace) but there are a few LNG-fuelled ships, which have been ordered. Among them there are four container ships ordered by the German ship-owner GNS Shipping/Nordic Hamburg. The vessels will later be chartered by the Finnish operator Containerships. The 170 m long, 1,368 TEU (alternatively 639 SECU) ships will be built by Yangzhou Guoyu Shipbuilding Co. Two ships are scheduled for delivery in the course of 2016 and the other two in 2017. Another ship that is scheduled to be delivered in 2015 is the ferry ordered by the Samsø Municipality and dedicated for a domestic Danish route. Investment in an LNG-fuelled ferry is also planned by ferry operator Tallink. In February 2015, AS Tallink Grupp and Meyer Turku Oy signed a contract for the construction of an LNG-powered fast ferry for the Tallinn-Helsinki route shuttle operations. The ship, with a gross tonnage of 49,000 will be about 212 metres in length with a passenger capacity of 2,800. The fast ferry will cost around € 230 million and will be delivered at the beginning of 2017. A ro-pax ship has been ordered by Rederi AB Gotland. The new ferry will be chartered to Destination Gotland, one of Rederi AB Gotland's subsidiaries, and put on its Nynäshamn-Visby line, replacing the two smaller and older high-speed crafts, Gotlandia (700-passenger capacity) and Gotlandia II (780 passengers). The investment (approximately € 160 million) was placed in the Chinese GSI shipyard. The new 1,650-passenger capacity vessel is scheduled for delivery in the first half of 2017.

The BPO has been taking and proactive role when it comes to planning and deploying the infrastructure for LNG bunkering in the Baltic Sea ports. The BPO has initiated and run two project called LNG in the Baltic Sea Ports (I & II), which focused on harmonised development of infrastructure for LNG bunkering, totally in 11 Baltic Sea ports.

Finally, to offset the additional cost incurred by switching to cleaner fuels in SECA, a number of shipowners and ship operators, whose ships call at ports within SECA, have decided to adjust the prices. Many of them have introduced a new low sulphur surcharge. The price adjustments were announced by regional ro-ro, container feeder shipping lines that operate exclusively in SECA as well as by large ocean container shipping lines for which ports within SECA are only a port of origin or destination.

In the case of large container operators, the new fuel charges vary depending on the carrier and by geographical range. The new charges range from \$ 30 per 40 feet container (for Asia to/from North West Europe) to \$ 280 per 40ft container (for the Baltic Sea region to/from Canada's East Coast). The Baltic Sea region seems to be the most affected by the new sulphur regulations (for the Baltic Sea region the new surcharge is around \$ 100 per 40ft container higher than for North West Europe). A new surcharge was also announced by feeder/short-sea shipping container lines. Depending on the operator and route, the surcharge ranges from \$ 100-300 per TEU.

In the case of ferry and ro-ro operators, it is currently hard to tell what the level of increase in freight rates is. Most ro-ro and ferry operators do not indicate the exact values. Several months ago, DFDS Seaways and Stena Line estimated that due to the new regulation, the freight rates will increase by around 15%. However, presently the price of low sulphur fuels is much lower than was expected several months ago, so the surcharges dependent on the fuel prices are probably not as high as it was previously expected and, in a consequence, the growth of freight rates is probably below the assumed values.

It must be, however, remembered that the freight rates to the large extent are shaped by fuel prices, so it may happen that the impact of sulphur directive on freight rates will be more visible in the future (if the fuel prices will increase and the difference between IFO and MGO will deepen).

5. Challenges ahead of Baltic ports – selected overview

Russia has been and remains to be the main market for many Baltic Sea ports: Looking at the countries surrounding the Baltic Sea region, Russia is a separate case. It has been and remains to be a big market for many Baltic Sea ports ranging from Gdansk and ending to Finnish ports. Russia's economic growth has been continuously slowing down for a few years now, mainly due to declining oil prices and difficulties in attracting foreign direct investments. In 2014 and in 2015, Russia's economic development slowed further, a massive devaluation of the Russian Rouble took place, foreign capital was scattering from Russia. Recent EU-Russia political relations, the low price of oil and other commodities, as well as a lack of economic reform do not let us see a bright future in returning back to trade volumes from a few years ago. Therefore, Baltic Sea ports – those involved in business with the Russian market – should adopt to lower volumes. However, one should remember that a weaker Rouble stimulates exports of Russian products (e.g. wood, fertilizers and chemicals). A positive trend in those categories of cargo has already been observed in some ports.

Big ports get bigger, what about smaller ones?: Due to the rules of the EU Transport Policy and related financing instrument (CEF), larger ports (those having core status) have better access to financing port infrastructure and have a priority status in the transport policy. Therefore, one can assume that these ports have preferable conditions to upgrade their infrastructure faster than medium-sized ports. Thus, they would attract more cargo and passenger. As a long-term consequence, a concentration of cargo transshipment in larger ports may occur. Moreover, the concentration trend in the port market could be further strengthened by two additional factors.

Firstly, there is a general trend in shipping that ships are getting larger as a response to market demand. For shipowners, larger ships leads also to a better utilising capacity, reducing costs and becoming more business efficient. This trend is very well observed in container shipping. It is rather obvious that these larger ships will call fewer ports and concentrate their cargo volumes in larger, deeper ports, which naturally further stimulates the concentration trend in the port market.

Secondly, a similar development has been caused by the new sulphur limits in marine fuels introduced in January 2015. In order to reduce costs caused by SECA rules, some shipping lines in selected market segments (e.g. paper) tend to concentrate cargo in selected ports (rather than bigger ports) and use larger ships. Similarly, cruise lines operating in the Baltic Sea are using larger cruise ships to accommodate more passengers on-board to reduce operational costs.

Changes in the port market are usually not a fast process, but a concentration trend in the port industry is expected in the next years, if not decades. It is quite likely that bigger ports may become bigger and medium-sized and smaller ports may face challenging times. This would push those ports to seek co-operation with bigger ports and/or to seek synergies between them (optimise costs and investments). Establish a regional or local alliance; merges are also possible scenarios in the next years to come.

More environmental regulation to come into the Baltic Sea: The Baltic Sea is a sensitive area and its environment has to be protected from pollution. Many environmental regulations, which are being introduced in the Baltic Sea, have a direct impact on maritime transport and ports. The BPO supports policy aimed at a clean Baltic Sea, but is also of the opinion that a balanced way of complying with implementing this policy and new regulations has to be found. Apart from the environmental benefits,

which should not be questioned, technology development, cost and market consequences for related industries have to be considered and studied as well.

When it comes to new environmental regulations affecting maritime transport, the obligatory delivery of sewage from passenger ships (ferries and cruises) in ports should be mentioned. According to the latest compromise between Baltic Sea countries, new regulations will be enforced by July 2019 for newbuild ships and two years later for older ships. Following the outcomes of HELCOM's report on Baltic Sea Sewage Port Reception Facilities (PRF), one third of cruise ships use PRFs while in ports.

Some Baltic Sea ports have already installed adequate facilities and many others are in the process of planning such facilities. However, quite a lot of ports are facing a real challenge when discussing the technological solutions with municipal wastewater companies as they consider sewage from passenger ships as industry wastewater. Moreover, the legislation framework must be realistic in order to smooth the process of deployment of adequate facilities at ports. The BPO supports the mandatory delivery of sewage from passenger ships as it will lead to a cleaner Baltic Sea by reducing discharge of nutrients to the marine environment. The BPO calls on local sewage companies for an open dialogue with ports in order to find a sustainable solution. During the planning phase for PRFs, national administrations also have a role to play in facilitating an open dialogue between ports and other local players. The BPO has organised a series of seminars and meetings where ports exchange their experiences and plans when it comes to meeting the future requirements.

Secondly, the so-called NECA regulations introducing new limits for ships regarding the emission of NO_x, will likely to be introduced in 2021. This will, of course, affect shipping lines, which have to introduce new technology on-board ships. Another regulation waiting for its introduction is water ballast management protecting the seas from introducing alien species, which will also impose costs for a ship-owner.

All of these environmental regulations have their unquestioned overall goal to protect the Baltic Sea's environment but there are specific Baltic Sea regions, which differ from other regions in the EU (when it comes to the regulation framework for the maritime transport industry). Thus, having different regulations (stricter for maritime transport) in one part of Europe than in another part creates an unfair market situation, which is against a level playing field in all of Europe and imposes a distortion of competition.

References

- Baltic Ports Organization (2014) Baltic ports in TEN-T Policy concerning the development of the Motorways of the Sea – achievements and future challenges August 2014.
- Baltic Ports Organization (2015) SECA is real now – A short report on implementing the EU Sulphur Directive and the first market reactions April 2015.
- Baltic Ports Organization (2016) Map with member ports March 2016.
- Baltic Transport Journal (2015a) Baltic Transport Journal (3/2015).
- Baltic Transport Journal (2015b) Baltic Ports Yearbook 2014/2015 (June 2015).
- DNV GL (2015) Maritime LNG fuelled vessels (March 2015).
- European Commission (2014) Map with TEN-T core network corridors:
<http://ec.europa.eu/transport/images/highlights/ten-t-corridors-2013.jpg>

Russian foreign trade flows and Eastern Baltic Sea seaports

Elena Efimova and Sergei Sutyurin

Executive summary

The article deals with the challenges faced by seaports of Finland and the Baltic States, resulting from recent decline in the Russian foreign trade. The authors share the view that the contraction in the Russian foreign trade primarily resulted from the general deterioration of Russia's economic performance accompanied by a dramatic drop of world oil prices. The economic sanctions imposed on Russia by Western countries as well as a retaliatory Russian ban on imports enhanced the decline. Assuming relatively high significance of the Russian Federation as a trading partner for Finland and the Baltic States, the contraction in Russian foreign trade turnover could be perceived as 'bad news' for their seaports. This is largely true both when we analyse the recent development and assess future prospects. At the same time, the authors suggest not to over-exaggerate existing commercial threats and risks. The diversification of production and logistical functions accompanied by a structural reorganisation might help seaports to enhance their competitiveness.

1. Introduction

Academic discussions dealing with the issue of interrelation between the performance of seaports, on the one hand, and basic trend in development of international trade, on the other hand, are traditionally based on several assumptions. The assumptions are the following:

- 1.) International trade by itself constitutes a certain good, since its expansion:
 - a) generates economic gains for the partners; and
 - b) helps to establish and secure peaceful political relations between participating countries.
- 2.) Transportation costs in general tend to perform as a factor hampering and limiting potential scale of international trade flows. Under the circumstances, one can hardly be surprised by the fact that the maritime cargo shipments account for the major part of international freight turnover. This largely stresses the high significance of seaports.
- 3.) The amount and composition of cargo handled by the seaports is largely results from dynamics and composition of international trade flows. At the same time, quality of performance, specialisation, and carrying capacity of the seaports influence value/volume as well as composition of foreign trade between individual countries.
- 4.) Since each seaport is interested to increase its freight turnover those of them that are geographically located relatively close to each other tend to compete.

The authors attempt to apply these assumptions to the analysis of the challenges faced by seaports of Finland and the Baltic States, resulting from declining foreign trade performance of the Russian Federation.

2. Russian foreign trade: recent development

During the past decade, Russia's foreign trade has experienced substantial changes. Fluctuations of the country's foreign trade turnover deserve a special attention. Table 1 illustrates the situation.

Table 1. Russian foreign trade in 2009-2015 (on the basis of the balance of payments data)

	2009	2010	2011	2012	2013	2014	2015
Exports							
\$ billion	303.4	400.4	522.0	529.3	523.3	496.7	340.3
annual change %	-35.7	32.0	30.3	1.4	-0.8	-5.1	-31.5
Imports							
\$ billion	191.8	248.7	323.8	335.4	341.3	308.1	194.1
annual change %	-34.3	29.7	30.2	3.6	1.7	-9.8	-37.0
Exports – Imports							
\$ billion	111.6	151.7	198.2	193.9	181.9	189.7	146.3
annual change %	-37.9	35.9	30.7	-2.2	-6.2	3.7	-22.9

Source: O sostoyanii vneshney torgovli v 2015 godu.

The authors agree with the majority of experts explaining the decline by a general deterioration of Russia's economic performance accompanied by a dramatic drop of world oil prices against the record level in mid-2008. One should definitely take under consideration the fact that in most cases at least for last half-a-century international trade demonstrated relatively high volatility. In comparison with both growth and contraction of GDP or industrial production, exports and imports tend to expand and decline more substantially. This 'general rule' is perfectly applicable to the Russian Federation. Indeed, in 2009 and 2015 the country's annual GDP contraction was 7.8% and 3.7%, respectively (BOFIT Russia Statistics).

Sanctions imposed on the Russian Federation by Western countries followed by a retaliatory Russian ban on imports of food also contributed to the overall decline of Russian foreign trade. In general, impact of these measures appeared to be relatively modest. At the same time, imports of individual product groups contracted substantially. Table 2 depicts relevant information presented by Russian Customs.

Table 2. Changes in Russian imports of selected products subject to import ban from non-CIS countries (percentage calculated on the basis of value preliminary data in US dollars)

	January 2016 against		January 2015 against	
	January 2015	December 2015	January 2014	December 2014
Meat and meat products	+18.3%	-72.4%	-75.6%	-89.3%
Fish	-7.6%	-40.6%	-58.1%	-55.0%
Dairy products	-25.3%	-29.8%	-78.3%	-61.3%
Vegetables	-26.3%	-31.8%	-40.1%	-26.9%
Fruits and nuts	-6.2%	-48.0%	-43.2%	-43.0%
Cereals	-5.9%	-57.9%	-44.3%	-54.8%
Vegetable oil	-24.1%	-42.5%	-12.4%	-18.0%
Sugar	-77.1%	-10.6%	-17.1%	+5.6%

Source: Authors' calculations based on Vneshnyaya torgovlya.

BSR Policy Briefing 1/2016

In line with the overall trend, Russia's trade with Finland and the Baltic States experienced substantial contraction in 2009. After a recovery, it again went into a decline starting from 2013 (with an exception of Lithuania). It was followed by further decrease in 2014 and 2015. Table 3 illustrates the development.

Table 3. Russia's foreign trade with selected EU member states in 2013-2015

Trade partner	Russia's exports, \$ million			Russia's imports, \$ million		
	2013	2014	2015	2013	2014	2015
Germany	22,962.14	24,950.27	24,638.15	37,904.57	32,947.34	19,909.56
Netherlands	69,259.51	66,683.27	38,670.53	5,837.16	5,264.87	3,016.63
Italy	29,164.84	28,991.19	21,795.94	14,563.30	12,683.36	8,102.87
Poland	19,408.18	15,760.46	9,513.00	8,321.28	7,069.39	3,997.79
UK	12,354.67	7,503.80	7,457.61	8,106.43	7,777.97	3,553.66
France	5,928.17	4,839.24	5,738.88	13,021.47	10,551.97	5,766.35
Belgium	7,726.44	9,225.94	6,026.58	4,034.00	3,573.50	2,029.61
Spain	6,027.06	4,575.81	2,518.16	4,914.63	4,342.49	2,739.96
Eastern Baltic Sea region						
Estonia	3,747.11	3,496.59	2,085.00	788.01	1,613.72	498.88
Finland	12,014.04	10,299.30	6,980.72	5,395.51	4,568.15	2,621.27
Latvia	9,836.42	12,486.99	6,938.93	802.77	651.42	383.16
Lithuania	4,878.83	3,640.09	2,799.75	1,117.29	1,005.36	437.47

Source: International Trade Centre. Trade Map.

Contraction of transit trade is a matter of serious additional concern in case of Finland. In 2015, transit exports from Finland to the Russian Federation equalled to just about 60% of the previous year. It appeared to be the fourth year of decrease in a row. The total value of transit freight was just € 8 billion in comparison with € 30 billion in peak years (Finland's trade with Russia declined sharply last year).

Commodity composition of Russia's exports and imports is a matter of substantial significance for the overall development of the national economy. The composition under review is twice as significant in defining specific requirements presented to domestic transport infrastructure as well as to these of trading partner-countries.

Table 4 depicts available information on major product groups in both components of Russian foreign trade. Mineral products continue to dominate in Russia's exports. Almost 40% contraction in this group's exports in terms of value was recorded in 2015. At the same time, oil exports increased in volume terms by 9.4% (O sostoyanii rynka nefi v 2015 godu). This trend is of clear relevance to the seaports that focus on handling of the Russian cargo.

Table 4. Major product groups in Russia's foreign trade in 2015

Aggregate product groups	Value (\$ billion)	Annual change (%)
Exports		
Mineral fuels, oils, distillation products, et cetera	216.101	-37.6
Metals and articles thereof	33.014	-18.3
Machinery, equipment and transport vehicles	25.386	-3.9
Chemical products, including rubber and fertilizers	25.338	-13.3
Food and agricultural products	16.181	-14.8
Wood and articles of wood, pulp and paper products	9.832	-15.6
Imports		
Machinery, equipment and transport vehicles	81.800	-40.0
Chemical products, including rubber and fertilizers	33.945	-26.9
Food and agricultural products	26.457	-33.7

Source: O sostoyanii vneshney torgovli v 2015 godu.

3. Implications for Eastern Baltic Sea seaports

One might claim that an overall decline in Russia's foreign trade turnover and the contraction of bilateral trade are really 'bad news' for the seaports of Finland and the Baltic States. Two major arguments seem to support this assessment.

Firstly, maritime cargo shipments, accounting for the major part of international freight turnover, should be positively linked with foreign trade of the countries. The Latvian foreign trade turnover dropped from € 17.9 billion in 2008 to € 12.6 billion in 2009. This drop was accompanied by a decline in total cargo handled by the Latvian ports from 60.1 thousand tonnes in 2008 down to 58.9 thousand tonnes in 2009. Corresponding data for Lithuania were € 37.2 billion in comparison with € 24.9 billion and 36.4 thousand tonnes in comparison with 34.3 thousand tonnes; in case of Finland € 128.0 billion in comparison with € 88.7 billion and 111.2 thousand tonnes in comparison with 90.5 thousand tonnes¹ (Eurostat).

Secondly, the Russian Federation is one of the major trading partners for Finland and the Baltic States. Table 5 depicts respective information from International Trading Centre database for the past three years. Under the circumstances, even taking under consideration mostly declining share of commercial transaction with Russia, fluctuations of bilateral trade flows really matter for overall ups and downs in these countries' foreign trade turnover.

¹ It was a matter of surprise that Estonia deviated from this general trend. In spite of contraction in foreign trade turnover from € 19.4 billion in 2008 down to € 13.6 billion in 2009, total cargo handled by the Estonian ports increased for the same period of time from 32.9 thousand tonnes up to 34.4 thousand tonnes.

Table 5. Share of the Russian Federation in foreign trade of Finland and the Baltic States

	2013	2014	2015
Estonian exports	17.9%	14.1%	9.6%
Estonian imports	9.3%	10.7%	9.6%
Finnish exports	9.4%	8.2%	5.9%*
Finnish imports	18.0%	14.8%	11.0%*
Latvian exports	11.6%	10.7%	8.0%
Latvian imports	8.4%	8.1%	8.4%
Lithuanian exports	19.8%	20.9%	13.6%
Lithuanian imports	28.1%	21.6%	17.3%

Note: * ITC does not provide data for Russian share in Finnish foreign trade for 2015, so the authors used here information from Customs Finland: Export volume decreased while export prices increased in December.

Source: Authors' calculations based on International Trade Centre. Trade Map.

In addition, one should take into consideration the possibility of more intensive competition with seaports of St. Petersburg and the Leningrad regions. These two regions of the Russian Federation have certain peculiarities in comparison with many Russian regions. Firstly, largely due to their geographical location² they are more deeply involved in various forms of external economic co-operation, including foreign trade. Table 6 illustrates the point.

Table 6. Foreign trade of St. Petersburg and the Leningrad region in comparison with the national average (\$ per capita)

	2013		2014	
	Exports	Imports	Exports	Imports
St. Petersburg	3,752	6,713	3,985	5,866
Leningrad region	7,443	2,738	8,617	2,351
Russia	3,647	2,382	3,457	2,144

Source: Authors' calculations based on Petrostat. St. Petersburg. Official Statistics. Foreign trade; Leningrad region. Official Statistics. Foreign trade.

More than that, above-mentioned geographical factor predefines one of these regions' economic focuses. They play the role of national logistical hubs and – as one might conclude from Table 7 data – specialisation on export of transport service. Russia's export diversification as well as the overall modernisation and improvement of the Russian transport infrastructure are currently on the national priority list. Under the circumstances, seaports of St. Petersburg and the Leningrad region have certain chances to get extra benefits from various federal and regional programmes. In combination with own efforts, this could enhance their competitiveness vis-à-vis their counterparts in Finland and the Baltic States.

² Peter the Great from the very beginning had designed St. Petersburg as 'a window to Europe'.

Table 7. Exports of services in 2013 and 2014 (\$ per capita)

	Russian Federation		St. Petersburg		Leningrad region	
	2013	2014	2013	2014	2013	2014
Total	452.9	448.2	563.7	487.1	243.3	302.7
Transport	143.6	140.0	358.8	305.4	240.8	301.1

Source: Authors' calculations based on Petrostat. St. Petersburg. Official Statistics. Foreign trade; Leningrad region. Official Statistics. Foreign trade.

Aforementioned threats faced by Eastern Baltic Sea seaports within the context of Russian foreign trade developments do not make both the current situation and the near future prospects as completely hopeless as it might look at the first glance. There are several reasons for a cautious optimism.

Firstly, the authors conducted statistical analysis of European statistical databases and trade data available from national statistical offices of Finland and the Baltic States. Although these data did not include the year 2015, the data allowed us to reveal relatively clear trend that is still valid. More specifically, in case of two out of four countries under review, namely Estonia and Finland, there was no significant connection between their bilateral trade with the Russian Federation and the amount of cargo handled by their seaports. Similarly, results of the analysis did not support the hypothesis of strong interdependence between the scale of activity carried out by the seaports and GDP per capita.

Secondly, in addition to the analysis of the overall trade flows, one has to pay special attention to the existence of what might be called 'sensitive' products. These are the products with more than 20% share of an individual country in their total exports or imports. For example, 'sensitive' Russian imports in Latvian exports means that share of the Russian imports of particular commodity is more than 20% in Latvia's total exports of this commodity. Twenty percent threshold corresponds with an official criterion of national security. Available statistics allow us to calculate with respect to 2-digit classification the amount of 'sensitive' product groups in trade of Finland and the Baltic States with the Russian Federation. Table 8 presents respective information. It goes without saying that higher number of 'sensitive' product groups tends to increase the dependency of the particular national economy on Russia. Under the circumstances, Finland and Baltic States might be interested in securing stable shipment of the respective products. In turn, from the perspective of their seaports that might mean more positive attitude of the national states towards their concerns.

Table 8. 'Sensitive' product groups in Russian trade with Finland and the Baltic States

	Number of 'sensitive' groups		
	2012	2013	2014
'Sensitive' Russian imports in Latvian exports	4	4	4
'Sensitive' Russian exports in Latvian imports	6	7	7
'Sensitive' Russian imports in Lithuanian exports	1	1	2
'Sensitive' Russian exports in Lithuanian imports	7	7	7
'Sensitive' Russian imports in Estonian exports	3	3	3
'Sensitive' Russian exports in Estonian imports	4	4	4
'Sensitive' Russian imports in Finnish exports	12	13	13
'Sensitive' Russian exports in Finnish imports	4	4	4

Source: Authors' calculations based on International Trade Centre. Trade Map.

BSR Policy Briefing 1/2016

Thirdly, regardless of the global economic slowdown and associated disturbances, Eastern Baltic Sea seaports in most cases – as Table 9 clearly illustrates – have managed to avoid dramatic contraction in their activity.

Table 9. Gross weight of goods handled in national ports (total cargo, thousand tonnes)

	2012	2013	2014
Estonia	40,632	39,452	40,172
Finland	101,685	102,186	102,464
Latvia	71,374	65,753	70,261
Lithuania	41,033	39,757	41,105

Source: Eurostat.

One possible explanation for this relatively successful performance could be the product specialisation of these ports (see Figure 1). In other words, it depends on the specialisation of the particular country in the international division of labour, including its interest in international transit. Estonian ports are specialised on liquid bulk cargo that helps to provide bunkering. Latvian international transit relates to modern ports facilities to handle dry bulk commodities, in particular grain, coal, fertilizer, et cetera. Container handling and ro-ro traffic ensure international industrial co-operation in Finland and Lithuania.

Figure 1. Specialisation of Eastern Baltic Sea ports

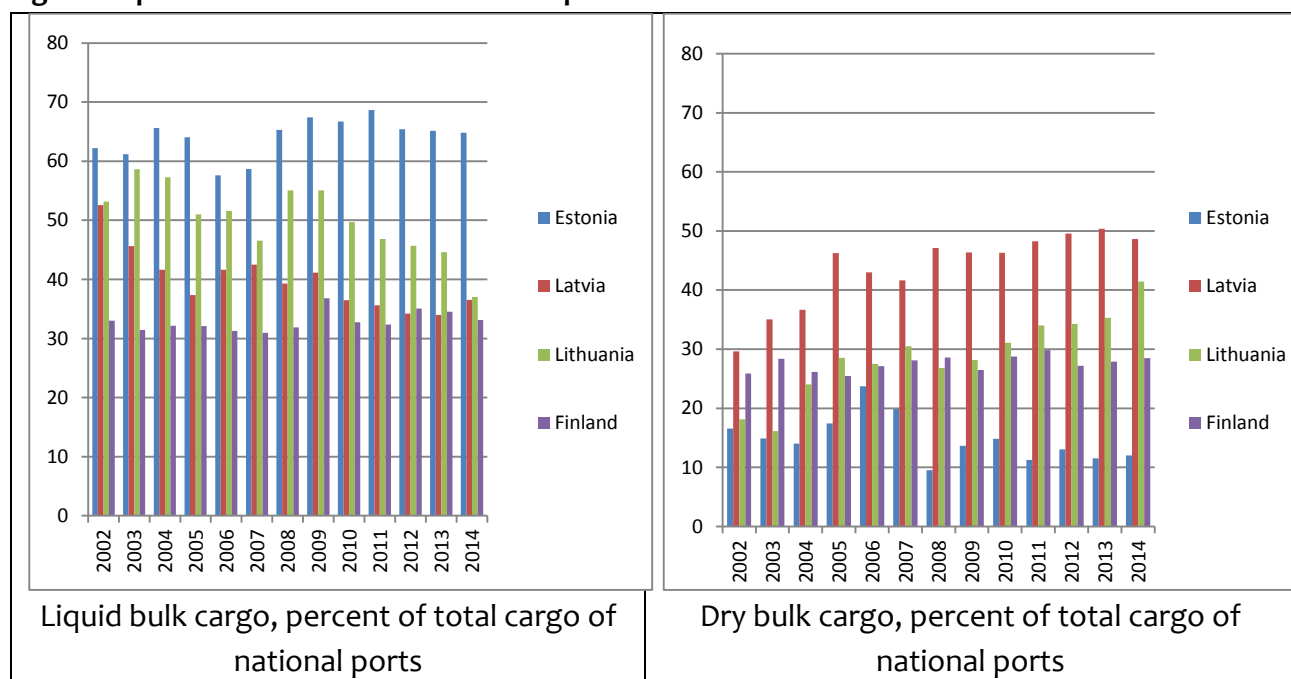

BSR Policy Briefing 1/2016

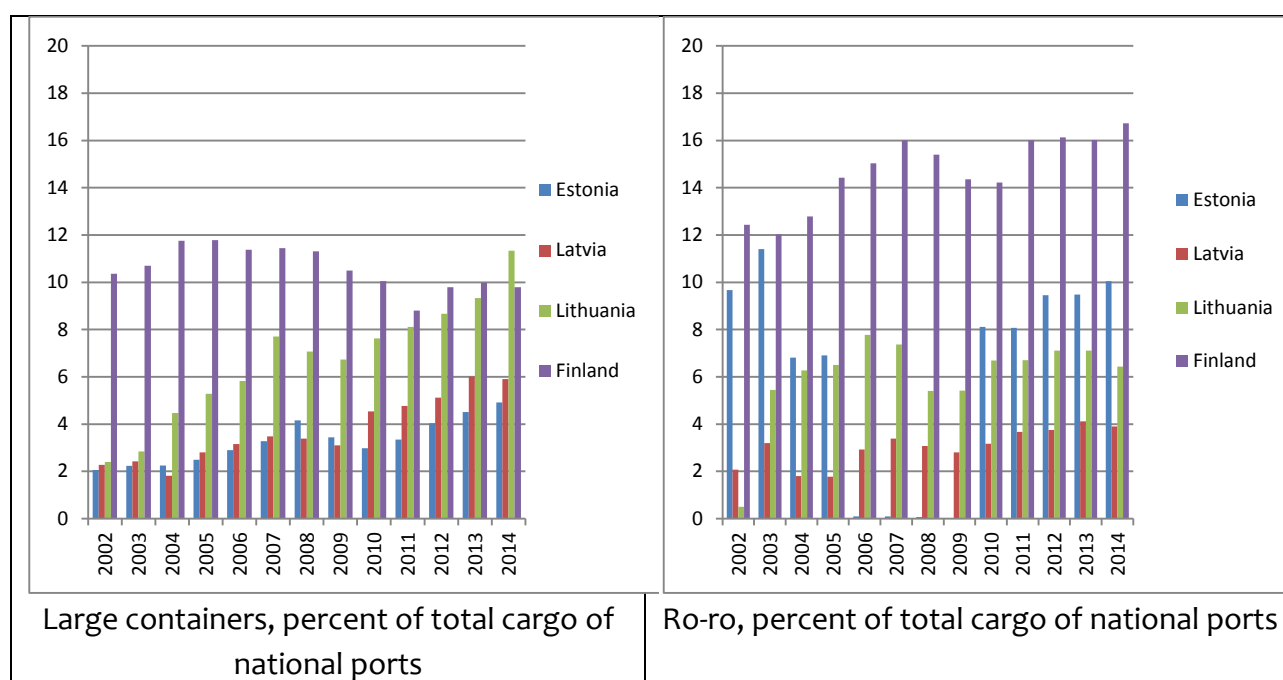

Source: Eurostat.

Finally, regardless of recent developments in several significant components of competitiveness, seaports of St. Petersburg and the Leningrad region are still lagging behind their counterparts in Finland and the Baltic States. Logistics Performance Index surveys conducted by the World Bank support this assessment. Overall index depicted in Table 10 is calculated as a composite of indices, such as efficiency of customs clearance process, quality of trade and transport-related infrastructure, ease of arranging competitively priced shipments, et cetera.

Table 10. Logistics Performance Index in the Eastern Baltic Sea region (1=low to 5 = high)

	2007	2010	2012	2014
Estonia	2.95	3.16	2.86	3.35
Finland	3.82	3.89	4.10	3.80
Latvia	3.69	3.72	3.08	4.06
Lithuania	3.40	3.92	3.70	3.60
Russia	2.37	2.61	2.58	2.69

Source: World Bank.

4. Conclusion

Recent contraction of Russia's foreign trade in general and the decline of Russia's bilateral trade with Finland and Baltic States in particular raise another challenge for the seaports of these countries. Some negative repercussions of the losses in handled cargo tend to matter not only for the ports per se but also for the national economies. Tension in relations between the Russian Federation and EU member-states facilitated economic deterioration once again sacrificing commercial interest for the sake of political ambitions. At the same time, the authors would suggest not to over-exaggerate existing commercial threats and risks. Diversification of production and logistical functions accompanied by a

BSR Policy Briefing 1/2016

structural reorganisation might help seaports not just to survive but also to enhance their competitiveness in a longer run.

References

- BOFIT Russia Statistics. http://www.suomenpankki.fi/bofit_en/seuranta/venajatilastot/Pages/default.aspx
- Customs Finland. <http://www.tulli.fi/en/releases/ulkomaankauppatilastot/tilastot/kktilastot/201512/index.html>
- Eurostat. Country level - Gross weight of goods handled in all ports.
<http://ec.europa.eu/eurostat/data/database>
- Export volume decreased while export prices increased in December. Finnish Customs, Statistics.
<http://www.tulli.fi/en/releases/ulkomaankauppatilastot/tilastot/kktilastot/201512/index.html>
- Finland's trade with Russia declined sharply last year.
http://www.suomenpankki.fi/bofit_en/seuranta/viikkokatsaus/Documents/w201609.pdf
- International Trade Centre. Trade Map. http://www.trademap.org/Bilateral_TS.aspx
- O sostoyanii vneshney trgovli v 2015 godu. Federal State Statistics Service of Russian Federation.
http://www.gks.ru/bgd/free/b04_03/IssWWW.exe/Stg/d06/35.htm
- O sostoyanii rynka nefli v 2015 godu. Federal State Statistics Service of Russian Federation.
http://www.gks.ru/bgd/free/b04_03/IssWWW.exe/Stg/d06/38.htm
- Petrostat. Leningrad region. Official Statistics. Foreign trade.
http://petrostat.gks.ru/wps/wcm/connect/rosstat_ts/petrostat/ru/statistics/Leningradskaya_area/foreign_trade/
- Petrostat. St. Petersburg. Official Statistics. Foreign trade.
http://petrostat.gks.ru/wps/wcm/connect/rosstat_ts/petrostat/ru/statistics/Sant_Petersburg/foreign_trade/
- Vneshnyaya trgovlya. Federal State Statistics Service of Russian Federation.
http://www.gks.ru/wps/wcm/connect/rosstat_main/rosstat/ru/statistics/ftrade/#
- World Bank. <http://data.worldbank.org/country/estonia>, <http://data.worldbank.org/country/finland>,
<http://data.worldbank.org/country/latvia>, <http://data.worldbank.org/country/lithuania>,
<http://data.worldbank.org/country/russian-federation>

The Port creates opportunities

Christian Ramberg

Turku was known as a lively trading post as early as the Iron Age when Baltic, Swedish and Novgorodian merchant ships sailed to the banks of the River Aura to trade goods. Turku became one of the key ports in the Baltic Sea in the 13th century when the cogs of Hanseatic traders dominated the view in the river harbour. Over the centuries, the Port of Turku moved along the River Aura towards the sea and ended up in its current location next to the Turku Castle.

Since those days, the Baltic Sea region has kept its position as the Port of Turku's most important operating area. However, alongside the main routes to the Nordic countries and Germany's Baltic Sea ports, there are now connections to the large ports on the North Sea and further to ocean lines around the world.

The role of Port of Turku Ltd has remained the same over the years. We are still a provider of opportunities in the commercial supply chain and work in close collaboration with the other logistics players, listening to the needs and wishes of different customer groups.

1. Important link for Finland's foreign trade transports

The majority of Finland's foreign trade is carried by sea, which is why ports have always played a decisive role in the success of Finnish businesses. Seaborne transports account for over 80% of both the exports of Finnish industry and imports to Finland, and the majority of that is carried through the ten biggest ports in the country.

The Port of Turku is the leading harbour for Scandinavian traffic in Finland and one of the most important unit load ports. The focus of goods transports lies in processed general cargo that requires careful load handling. Most of these transports are project shipments of Finnish heavy industry destined to Europe, as well as the Asian and American markets. Goods exported via Turku include, for instance, mining machinery, highly processed steel products, and forest industry products. Imports via the Port comprise a wide range of product groups, from vehicles to household appliances and from fast-moving consumer goods to industrial raw materials and components.

Thanks to its fast connections, the Port of Turku is an important stopping point for truck transports via Scandinavia. For heavy vehicles, the Port of Turku offers short turnaround times and congestion-free connections to Finland's main roads. The route between Turku and Stockholm is a competitive alternative in terms of time also for goods transports from Finland to the rest of Europe. The new services for truck traffic aim at improving both the smooth flow of traffic and services for the drivers.

2. Expert partner in the world's leading maritime cluster

The Port of Turku is an important part of the maritime cluster of Southwest Finland whose core comprises of the maritime industry, seafaring businesses, and port operations. The roots of the shipyard industry lie at the mouth of the River Aura, where shipbuilding continued up to the mid-1970s when the shipyard operations were transferred to Perno district. Located on Raisio-lahti bay and currently owned by the German shipbuilder Meyer Werft, the shipyard is known as the leading cruise liner builder in the world and a pioneer in its field.

For the Port of Turku and local logistics operators, Meyer Turku is an important partner in materials management of the shipyard. The company's storage need related to shipbuilding has increased, because the shipyard handles by itself the storage of an increasing share of the goods destined to vessels being built. Although the shipyard has plenty of storage space in its area, storing all the goods there is not sensible or even possible.

The subcontractors of the Meyer Turku Shipyard use the services of different service providers in the port for their storage needs. Cabin modules ready for installation and other products are stored e.g. in the Pansio Harbour and the Free Zone Company of Turku. Large items, such as lifeboats are kept on the outdoor storage area in the West Harbour. Some of the shipyard's subcontractors process their products ready for installation in the logistics companies' hall premises.

The maritime cluster, on the whole, has great significance to the well-being of Southwest Finland by providing jobs in the area. Including indirect jobs, the maritime cluster is estimated to employ some 27,000 people in Southwest Finland and Satakunta, or 8.5% of the employed people in the region.

3. A visible player in its home city

The Port of Turku is an important player from the point of view of the City of Turku and its inhabitants. The existence of the Port has in many cases been decisive e.g. in the promotion of projects aimed at improving the traffic connections to and from Turku. In addition to the E18 motorway, they include e.g. the basic renovation of Highway 8, which is the main route for goods transports on the west coast, and traffic arrangements in the city area. The goal is to increase the smooth flow of traffic in the city-centre by guiding heavy vehicles from the Port directly to the main roads via Turku bypass road.

The Port is an important employer both directly and indirectly. There are around 80 people working in the Port of Turku's own organisation, in addition to which other operators in the port area employ over 1,000 people. The logistics industry is estimated to employ in total some 13,000 people in Southwest Finland, and turnover of the industry in the province is over € 1.7 billion. Together with the rest of the business world, the Port of Turku aims at further strengthening the position of the Turku region as a key logistics hub of Finland and the Baltic Sea. By increasing the flow of goods, the Port of Turku at the same time increases the vitality of the economy and the well-being of people in the whole region.

In addition to financial benefits, the Port strengthens Turku's image as an active, international and vital city. The Port's location near the city-centre promotes interaction with the inhabitants. The Port has participated in refurbishing the streets from the city-centre to the port by the River Aura, and in

organising many major events in the city. One of those is the Tall Ships' Race which will arrive in Turku for the fourth time in 2017.

4. A strong player at the heart of the European traffic networks

The Port of Turku is a modern European port at the crossroads of the key traffic routes of the Baltic Sea. The Port's position at the centre of the traffic flows is strengthened by the Port of Turku's inclusion in the TEN-T core network that forms the logistical backbone of the European Union and combines different modes of transport. On the map confirmed by the European Commission the Port of Turku is included as part of the Scandinavian–Mediterranean Corridor that extends from Turku via Helsinki all the way to St. Petersburg. The Port's connections included in the core network are the E18 motorway and the railroad between Turku and Helsinki.

The E18 motorway is one of the most important routes between the east and west in Europe. Starting on the coast of Norway, it passes through Stockholm, Turku and Helsinki, and forms a cost-efficient corridor through Scandinavia all the way to St. Petersburg.

The Port of Turku contributes actively to European co-operation organisations for maritime traffic. The Port has representatives, for example, in the European Sea Ports Organisation ESPO's Intermodal, Logistics & Industry Committee, and the EU Commission's Scandinavian-Mediterranean Core Network Corridor Forum.

5. Industry pioneer in environmental issues

The location of the Port of Turku at the heart of the sensitive nature of the Baltic Sea requires continuous follow-up of environmental impacts and prevention of adverse effects. Individual measures for improving the Port's environmental issues and minimising the environmental impacts are determined in the Port's environmental programme. In addition, the Port draws up annually an environmental report which collects the measures and follow-up implemented during the year.

The Port of Turku has been a pioneer in environmental issues for a long time. For example, environmental port charges were introduced in 2006, and the vessels calling at the port have the opportunity to drain their wastewater there. At the same time, the port enterprise has considerably enhanced the energy-efficiency of its own operations and reduced the environmental impacts of the port operations.

In order to decrease the environmental impacts of maritime traffic, the Port of Turku collaborates e.g. with the maritime cluster and numerous stakeholders. The sulphur emissions of new vessels are reduced by switching to environmentally sound fuels, such as liquefied natural gas (LNG). Built at Meyer's Turku shipyard, M/S Viking Grace has been sailing between Turku and Stockholm using LNG as fuel since the beginning of 2013. The Port of Turku has plans in place for building an LNG terminal in the port area, and there will also be a filling station for trucks that use LNG as fuel.

In 2015, the ports in Finland and Sweden initiated co-operation in environmental issues with the purpose to develop the sea connections between the countries. Finland's three TEN-T core network ports – Turku, Naantali and HaminaKotka – together with the Port of Stockholm and Viking Line invested € 8.1 million in

order to reduce the environmental impacts of vessel traffic on the Baltic Sea. The co-operation project includes preparation and building of wastewater reception facilities and investments related to the use of land electricity on ro-ro and ro-pax vessels. It also includes planning for the reception of oily waste and bunkering of LNG. Viking Line ferries sail between Turku and Stockholm, and the company aims at developing a safe, efficient and environmentally sound ro-ro passenger ferry concept for the traffic on the route.

To improve the state of the Baltic Sea, the Port of Turku also participates in the Baltic Sea initiative started by the Cities of Turku and Helsinki in 2007. The core of the initiative is formed by the concrete water protection measures in the operations of the involved organisations which exceed the minimum requirements of the legislation.

6. Quickly reacting developer of port operations

The Port of Turku's future goals are determined by the mission and vision of the port enterprise. According to them, the Port of Turku acts as a flexible centre of maritime traffic and promote the competitiveness of the business world. The Port focuses on support functions for passenger traffic and transports of processed goods and works continuously to enhance them. Together with other logistics and transport providers the Port of Turku aims at developing new and existing services as per the needs of shipping companies and their customers. The operations emphasise flexibility and quick responses to the customers' changing needs and even surprising situations.

A good example of the achievements is the opening of new sea routes from the Port of Turku that serve Finnish export industries in particular. At the same time, the vessel stock in both passenger and cargo services have been renewed to provide more capacity and diversify the supply of transport services. The port enterprise has supported the development of the service concept together with partners e.g. by renovating the Port's infrastructure, such as the quays, terminals and cranes, and by investing in extensive warehouse construction.

Speed is an essential element to the Port of Turku's competitiveness. In addition to the fast ship connections, it means e.g. smooth load handling, easy embarkation and disembarkation of passengers, and good road connections to the key cities. The importance of speed is visible particularly in the Swedish traffic as the timetable allows for a maximum stay of one hour in the port.

The goal of continuous development work is to provide the most efficient services to all those for whom time matters.

The Port of Ust-Luga – New window to Europe

Oleg Dekhtyar

The idea of construction a sea port in the south part of the Gulf of Finland first appeared in the 16th century. In the 1930s, the plans to build a port were more real as the project of naval base in the Luga Bay came in to sight but the materialisation was postponed due to the Second World War.

Next time the plan of building a sea port in this location recurred after the fall of the Soviet Union when major ex-Soviet deepsea ports moved into the free Baltic States jurisdiction. On the other hand, the capacities of Saint Petersburg Sea Port turned out to be seriously restricted as the port facilities are located within the city borders as well as because of shallow depths in the waters of the Western part of the Gulf of Finland.

The project of construction of a Sea Commercial port in the Luga Bay started in 1992 when the joint-stock Ust-Luga Company was established. There are a number of advantages of the port location as compared to St. Petersburg one:

- geographical position on the crossing of the cargo flows North-South, East-West;
- deeper sea waters near the port;
- shorter length of the Sea Canal 3.7 nautical miles instead of 27 nautical miles;
- canal width (180 m) and depth (up to 18 m) allow a two-way traffic of big tonnage vessels in the canal as compared to one-way traffic in St. Petersburg Sea canal. The Ust-Luga Sea Canal allows accepting vessels of the biggest dimensions which are allowed for passing of the Danish Straits;
- more favourable ice conditions in winter as the ice navigation period in the area is shorter than in St. Petersburg and the bay is less packed with drift-ice which is frequent in winter time on the approaches to the St. Petersburg port;
- closer position to the border with the EU;
- vast undeveloped areas around; and
- closer location with Leningrad Nuclear Power Plant energy facilities.

However this large-scale infrastructure project appeared to be so complicated and economically challenging that it was frozen for several years until the milestone change of shareholders in the JSC Ust-Luga Company in 1999 when part of shares were transferred to private investors. The conclusion of agreement on mutual obligations between the Ministry of Transport, the Leningrad Region Administration and JSC Ust-Luga Company became one of the first examples of state-private partnership in modern Russia. According to that agreement, JSC Ust-Luga Company acts as a customer-developer for construction of terminals and facilities of the Ust-Luga port, which are not a state property. There appeared following division of the tasks: JSC Ust-Luga Company arranges for construction of terminals and infrastructure on the lands leased from the state. The Ministry of Transport is in charge for constructions of sea canals and dredging, JSC Russian Railways is to provide external railway approaches to the port, the Leningrad Region Administration gives the land and provides for engineering, transportation and social infrastructure objects. In order to run the project in which some private investor showed interest, JSC Ust-Luga Company is to establish a daughter

company at some stage of its realisation and then to sell a share or the whole company to this investor.

Such structure made it possible to build a port with all objects of infrastructure except the waters and navigation systems being private property. The terminals were constructed involving the funds of the strategic investors – cargo owners and logistic companies of national level. Starting from 1992 the investments into port structures achieved RUB 200 billion (about \$ 8 billion) whereof only 16% were the funds of the state whereas the rest were the money of private banks, companies and investors.

Nowadays there are 8 main terminals currently operating.

Coal Terminal Rosterminalugol owned by one of the major coal mining companies Kuzbassrazrezugol is nowadays a modern terminal specialising on handling of bulk coal accepting vessels up to 80,000 deadweight tonnes. In the year 2015, the turnover of the terminal made 17.5 million tonnes.

The Motor-Railway Ferry Complex owned by the state company Rosmorport is a part of the multipurpose motor-railway ferry service Ust-Luga – Baltiysk – Sassnitz started functioning in 2006 and in 2008 there started a regular traffic to Baltiysk (the Kaliningrad outpost). According to the statistics of the year 2015, the turnover of the complex made 22,800 railcars and 10,500 vehicles, total 2 million tonnes.

In 2006 there started construction works and in 2009 the Technical Sulphur Transshipment Terminal began functioning. It is fitted with modern equipment and warehouses for handling and storage of fertilizers as well as granulated sulphur and sulphur lumps. In 2015 the turnover of the terminal reached 2.6 million tonnes.

JSC Universal Reloading Complex started its activity in 2008 (in 2008-2010 the 100% shares were owned by Universal Cargo Logistics Holding, one of the biggest port operator in Russia). The main focus of the cargo is coal and some other bulk cargoes. Turnover of this terminal in 2015 reached 4.1 million tonnes.

The construction of Multipurpose Reloading Complex Yug-2 started in 2006 and two years later there was introduced the first start-up complex. It is the only terminal of the port which is operated by JSC Ust-Luga Company. Initially the terminal was used for discharging and storage of import cars. Starting from 2010 the terminal also accepts general cargoes. Total length of berths is 903 m, maximum depth 12.8 m. The territory of the terminal takes total 89 hectares of which only 48 hectares are developed lands. The terminal specialised in fertilizers, steel products, sawn timber, project cargoes, vehicles and cars. Turnover in 2015 is total 2.2 million tonnes.

In December 2011, there started the first start-up line of the JSC Ust-Luga Container Terminal – first deepsea container terminal in the North-Western part of Russia. In case the terminal will reach its full capacity it will be the biggest and most developed container terminal with modern equipment, maximum draft 16 m and the turnover of 2.6 million TEUs per year. The terminal is the part of Global Ports Group one of the major Russian terminal's operators. Group's main shareholders is APM Terminals BV owned by Maersk. The terminal works with Maersk Line, CMA CGM, Unifeeder, Hapag Lloyd and Team Lines.

The plans of building the Baltic Pipeline System II estimated for crude oil transportation made a strong impact on development of the port. Simultaneously with pipeline there started the construction of oil

tank farm and infrastructure in the port of Ust-Luga. The first line started in 2012 and its designed capacity is 30 million tonnes of crude oil per year. Next stage is building the second line of the complex with increasing of the turnover up to 50 million tonnes per year. The drafts on the fairways and at the berths allow to accept vessels with deadweight up to 160,000 tonnes. The terminal specialises not only in crude oil which is transported via pipeline but also focuses on oil products delivered by railways. In 2015, the turnover reached 26.3 million tonnes of crude oil and 21.7 million tonnes of oil products.

In 2013, there started a complex for stable gas condensate fractioning and transshipment owned by JSC Novatek (vertically integrated company, Russian independent producer of natural gas). The terminal accepts tankers with deadweight up to 120,000 tonnes. This complex is planned for refining the stable gas condensate into light and heavy nafta, kerosene, diesel and fuel oil and export of the products by sea transport. In 2015, the complex turnover made 6.8 million tonnes of different products.

In the same month, the LPG and light oil products terminal SIBUR Portenergo started functioning with export of JSC Sibur Holding cargoes. In 2015, the terminal turnover reached 2.6 million tonnes of oil products and 1.6 million tonnes of LPG.

The full designed handling capacity of the port is 178 million tonnes. The total turnover of the port in 2015 reached 87.8 million tonnes which shows 16% increase in comparison to the 2014 figures. Such intensive growth requires very attentive approach to the development of infrastructures, especially the railways. Initially it was reasonably decided to link the port with the main railway St. Petersburg – Moscow roundabout the congested railway approaches to St. Petersburg. At the same time, the port develops its own multipath railways infrastructure which allows to split the cargo flow in two major directions – northbound (exports) and southbound (imports). The train operations are planned to be organised in a closed circle in order to avoid congestion for cross movement of loaded and empty railway cars.

The opening of the yard railway station in June last year became an important event and in case station is used at full capacity it might become the largest railway yard in Europe. The gravity hump which designed capacity is 5000 railway cars per day is fitted with Siemens microprocessor centralisation system MSR 32. Usage of the system allows to achieve full automation of main processes including train dissolution, railway points control, braking systems, et cetera. Last year the maximum reported rail cars handling capacity of the port reached 3500 cars per day.

The motor roads access has also been being developed intensively. According to the project the port will be linked to the highway St. Petersburg – Moscow via Veliky Novgorod with a modern express highway thus making the distance difference between Ust-Luga and St. Petersburg to Moscow only 33 km.

The Ust-Luga Company plans to go on further developing of the port Ust-Luga within the framework of the project ‘Complex development of the Ust-Luga sea merchant port and the adjacent territory’, based on five interconnected clusters: industrial, transport, recreational, agro-industrial and city cluster. The port has become a driver of a social-economic growth of the whole region.

It is quite natural that nearby a big inter-modal transport junction industrial development is inevitable. Industrial zones near big ports usually have a special economic status and develop quite successfully. In 2015, Gazprom made a decision to build a liquefied natural gas (LNG) plant near the port, total of 10

million tonnes per year, with possible increase up to 24 million tonnes per year. The Gazprom project also provides the region with additional 12 million tonnes of gas a year for setting up new plants, the consumers of gas. According to the project, in the Ust-Luga industrial area, such sectors as polymer, general industrial and logistic ones are supposed to be constructed.

The Ust-Luga port is a final destination of BTS -2 (Baltic Pipeline system). The pipeline is supposed to be used not only as a means of transportation of crude oil for export but as a way of delivery raw materials to oil-processing plants, located close to port terminals, which specialise in transshipping their production.

The area of the future Ust-Luga industrial park is 1,548 hectares, including the first order of 690 hectares. About 50 enterprises are supposed to be built with a number of employees over 17,000 people. The investment in the infrastructure is RUB 68.7 billion, the target date of realisation of the project is 2016-2030.

The port and enterprises are supposed to be provided with qualified personnel that will get comfortable accommodation and recreation facilities. It is necessary to minimise and compensate negative consequences of the industrial developing of the new territories.

Therefore the development of the project on building the sea merchant port Ust-Luga requires coordinated construction of the recreational, agro-industrial and city clusters.

The port town Ust-Luga with settlement of 35,000 residents is already under construction. The build-up area is 1,849 hectares. In this new satellite town it is supposed to combine highly compact zones with 4-storey buildings, medium compact planning area with 2-storey houses and low-rise cottage zones with total household area of 1,035 thousand square meters. It will allow houses to blend with a countryside landscape.

Some free territories near the Ust-Luga port give a possibility of arranging some agricultural projects as well. There is an idea of constructing a meat-processing complex that will help to provide the North-West region of Russia with their own local production.

The port complex is being constructing in a full compliance with the environmental legislation. Ust-Luga Company realises its responsibility for the region's future and endeavours to reduce the technological processes affecting the environment. In the autumn of 2009, with a view to solve the full complex of the environment related questions arising with the Port's developing and to centralise the procedure of creating the Port's sole ecologic infrastructure, JSC Kingisepp Ecological Company, a subsidiary company was established. The Company was to deal with centralisation of waste collection and recycling, constant monitoring of environmental situation in and around the Port complex, centralised assurance of strict compliance with environmental control bodies' requirements by all the companies operating at the Port.

Port is surrendered with beautiful untouched nature Reserves and Wildlife Sanctuaries and Ust-Luga Company considers preserving corners of intact nature to be the goal as important as raising industrial facilities.

Maritime cargo traffic in the framework of transforming transport corridors – Can scenario-building bring clarity ?

Erik Terk and Alari Purju

Executive summary

The article points out factors affecting the future dynamics of maritime cargo traffic between Finland and Estonia and prospects of the Port of Tallinn (Tallinn-Muuga) for becoming a significant international cargo hub. The subject is viewed in a broader geo-economic and geopolitical context, concentrating on factors, such as the expansion of Finland's foreign trade geography, the launching of the Rail Baltic railway, the attraction of some of the cargo moving via the Arctic route through Finland and Estonia, and the amplification effects possibly emerging from the handling of east-west and north-south cargo flows. The opportunities have been viewed within two scenarios, one of which presumes higher growth rate of the international economy and relatively normal relations between Russia and the European Union, while the other presumes slower growth rate of the global economy and a situation, where the Russia-EU economic relations are obstructed by (geo)political tensions.

1. Changing cargo traffic logistics

International cargo traffic logistics with maritime cargo traffic as one of its elements will undergo significant shifts. This includes, for example, certain relocation of the East Asian and European transport connections. While the zone of North Sea transcontinental ports used to clearly dominate the trade of East Asian goods to and from Europe, today's agenda includes the entry of larger container ships carrying East Asian goods to the Baltic Sea as well as the opening of the Arctic Ocean route. Russia is attempting to concentrate its exports and imports of goods in its own ports and to reduce the use of the border countries' ports and other transport infrastructure. One can name the construction of the Ust-Luga and Primorsk ports and the North Stream pipeline as examples of the aforementioned policy.

A move of considerable importance is the construction of the Rail Baltic railway route, which does not merely provide a better connection between the EU border countries and the so-called core Europe, but effectively creates a potentially highly competitive north-south transport corridor in the EU's eastern region, opening new opportunities for long-range logistics in that direction. The impact of this corridor extends significantly further northwards from Tallinn and southwards from Warsaw. This includes the introduction of stricter ecological norms for transport, which could result to some extent in a modal shift, dependent on the mode of transport affected and the toughness of the standards (e.g. the recent case of the sulphur directive). Finland and Estonia, together with Latvia, Lithuania, North Poland and Belarus, form a transit handling area in the European context. This transit has been predominantly of east-west/west-east direction – handling the westbound movement of Russian and Kazakh energy carriers and raw materials to core Europe and the North Sea transcontinental ports and the eastward traffic of Russia's imported goods originating in the same zones. The emergence of Rail Baltic will add a new component in the transit handling infrastructure. While Finland's transit activity has been so far

mainly concentrated in the ports of Southeast Finland, the increasing importance of a new north-south corridor will boost the role of the Port of Helsinki, and the Helsinki-Tallinn maritime link should be viewed as one element in a north-south transport corridor, significantly longer than it used to be.

2. The importance and the underlying logic of building the scenarios

Due to the changes in the European cargo transport logistics, the ports and port operators find themselves in a situation, where the profitability of their investments will depend on the success of launching transport corridors and on these corridors' ability to succeed in competing over cargos and passengers. The situation is further complicated by several factors. The corridors may link or pass through potentially problematic countries, making it necessary to consider political factors besides the economic ones. These corridors handle multimodal traffic. Which ports will become the region's important hubs does not depend on the ports alone, but on the efficient functioning of all modes of transport operating within the corridor and the optimal connectivity of the various transport modes (especially maritime and rail connections). As the ports may be located in the crossing points of north-south and east-west cargo flows, it would be necessary to consider the amplification effect of these flows (economy of scale, risk distribution, et cetera). In this situation, it would be practical to use the alternative scenarios to aid analysis.

The scenarios can be built either proceeding from principally different alternative strategies already formulated (oriented towards handling some particular cargo flows, decisions regarding specific investments necessary for these cargo flows) in order to forecast the outcomes of these strategies in possible external circumstances, or proceeding from various alternative 'future worlds', which could potentially emerge. In the latter case, the actors operating in the transportation market could see via scenario analysis, how the main subjects of the analysis (important components of the situation) may be modified by the different external conditions and which outcomes could be reached.

The following text provides an example of scenario analysis concerning the study of Helsinki-Tallinn maritime traffic prospects. The selected central subjects of the analysis are the launching of the Rail Baltic railway line, the southward expansion of Finland's foreign trade geography and the connections in handling the north-south and east-west cargo flows. The estimated time horizon of the analysis is 20 years. We presume that this horizon does not encompass the possible construction of an undersea tunnel between Helsinki and Tallinn. The composed scenarios differ as to the state of external environment, i.e. more or less favourable conditions for business activities.

Regarding the external (business) environment, two basic components have been outlined in the scenario building – the economic (related to the rate of economic growth) and the foreign political ones. It is presumed that although these two components do not need to move in the same direction at all times, certain correlation between them can be expected in the longer perspective. Higher economic growth in the world and in Europe should in general reduce the threat of geopolitical conflicts, and vice versa, strong foreign political tensions reduce the prospects of continuing economic growth. The scenarios view a potential additional volume of maritime cargo traffic on the Helsinki-Tallinn route.

The article attempts to view the topic in a wider geographical context and to address options concerning all-European and transcontinental north-south (south-north) combined (multimodal) cargo traffic rather than traffic only within the EU.

We avoid presenting many figures in this article, since they could change quite quickly by time. Each scenario definitely requires the refreshing of quantitative indicators on the basis of the latest information. We shall only present the basic logic of the scenarios and some resulting conclusions, which probably should not change in case of smaller variability of the situation.

3. Helsinki-Tallinn maritime cargo traffic: two scenarios

3.1. Scenario 1. Business opportunities in case of relatively high economic growth and absence of strong geopolitical tensions

3.1.1. Background

Despite the recently increased international tension, we do not presume within this scenario any global conflicts, which could undermine international economy. According to this scenario, the European economy will develop at a rate of around three percent per year during the period as a whole. Some setbacks will be experienced during the period, but none of them could be compared to the scale of the last global financial crisis. East Asia, continuing to display growth, although not as fast as previously, remains the main 'engine' of international economy, while the growth rate of Europe's economy is significantly lower due to the aging population and other reasons. Foreign trade, both inter-European and transcontinental, shows faster growth compared to GDP growth (although this speed varies among countries). Growth rate of Europe's so-called post-socialist economies, the new member countries and eastern partners as well as Turkey is somewhat higher than that of 'old Europe' and the same applies to the related foreign trade volumes. Russia's relations with the EU have significantly deteriorated since the crisis in Ukraine, but we do not presume the escalation of military conflicts within this scenario. The EU is cautious regarding Russia and takes measures, although not very consistently, to reduce its energy dependence on Russia. Russia is engaged in creating the Eurasian (Economic) Union, which is making gradual progress (involvement of Ukraine in the aforementioned union can be ruled out after the recent developments). Belarus is a member of the Eurasian Union and its economy is therefore under strong Russian control. Turkey's joining the Eurasian Union will not become topical. The existence of the Eurasian Union makes it necessary to keep in mind that issues, such as the use of Belarus railways or the exports to the Kazakh market will be settled in the future via negotiations with the Russia-dominated Eurasian Union rather than by means of bilateral talks with the corresponding countries. The EU will have no other option but to gradually recognise the Eurasian Union as a partner and to find some modus vivendi, not excluding agreements with the new economic bloc. It is possible that such agreements would cover the use of the Arctic shipping route. In case, Ukraine's further movement towards European integration can be ensured, the EU may have to give guarantees to Russia and more widely to the Eurasian Union that the latter's interests regarding the Ukrainian market would not be harmed.

Russia despite its favourable position in the energy carriers and raw materials market is not successful in its attempts to modernise its economic structure. The growth rate of Russian economy is low. Therefore, it can be presumed that Russia's negotiating positions with the West, including in economic issues, will weaken rather than strengthen over time.

BSR Policy Briefing 1/2016

The EU will continue the policy of integrating its economic space. An organic part of this policy is the improvement of its transport infrastructure. This includes the Rail Baltic project. Some Balkan countries (Serbia) can join the EU by the end of the period under observation, but the terms will be substantially tougher than the ones granted to Bulgaria and Romania. Economic co-operation with Ukraine, Moldova and Turkey will be advanced, partly for political, partly for economic reasons. They would not be granted the full EU membership during this period, but some intermediary options could be developed with less exacting standards than those of full members.

Finland's economy will develop at a medium but quite stable rate. It has to be considered, however, that Finland is gradually shifting from the exports of products to exports of capital and services, which no longer produces large growth in export volumes. The EU policy continues to emphasise ecological issues.

One aspect of this scenario is that relatively strong economic growth is connected to increasing demand for oil products and price of oil will increase from very low level at the moment to at least \$ 80-100 per barrel in five years perspective. That changes the impact of fuel process on choice of transportation modes. The sulphur directive introduced in 2015 and other regulations had practically no effect on fuel prices because the deep price decrease covered practically all extra costs related to fulfilling the requirements of the directive. Increase of oil prices will make these extra costs more visible. However, the period of low oil and fuel prices during 2015 and 2016 gave companies extra time to introduce necessary changes.

As the aim of EU regulations has been to support moving transport flows away from roads, it is possible to expect that the opposite effect achieved by sulphur directive will be balanced by regulations underlying this main goal, that is, railway and sea transport will be kept relatively cost effective in comparison with road transportation. This means that cargo flows are forced from roads to railways or sea. Actions driving cargo flows from the sea to railways are less probable.

3.1.2. Demand for north-south (south-north) cargo traffic

Demand for cargo traffic across the Gulf of Finland is not limited to developing economic co-operation with traditional southern partners of Finland, where the increasing intra-industrial trade is huge driving force for traffic, but it is also largely related to further southward expansion of the geographic area of Finland's exports and imports.

The increase of such traffic can be expected on both the western (countries to the west and southwest of Poland) and eastern (Eastern Mediterranean countries and Ukraine) flanks of the southbound direction. The former concerns traffic to EU countries and/or through them. As this is a relatively stable and predictable political and economic environment, it can be expected that Finland's foreign trade relations with these countries should become closer in the future. In case of generally good all-European economic climate, we may expect decent, however not very high economic growth in these countries. The largest markets in that direction are Poland and Italy. Above average economic growth rate can be expected in Poland, but the Helsinki-Tallinn-Warsaw transport corridor is facing strong competition of maritime traffic from Finnish ports to the ports of Gdansk and Gdynia. In Italy's case, we can probably view only the country's north-western part as clearly belonging to the rail transport

corridor's catchment area. Of course, opportunities for using that corridor will significantly improve after the launching of Rail Baltic, which will result in quite different cargo traffic speed. Until that time passing through Latvia, Lithuania and Poland, whose railway lines are built for east-west cargo traffic rather than north-south traffic, will remain a bottleneck for north-south direction railway traffic.

In case of well-functioning rail connections, it is possible that a share of cargos related to Finnish goods could move over the southern corridor to Mediterranean ports. The southern transport corridor's catchment area covers the Balkans, Turkey and Ukraine. In case of normal political climate, they are large and potentially growing markets. The opportunity of exports from the Black Sea (e.g. from the Odessa-Ilichovsk ports) or the Mediterranean ports to Turkey and elsewhere should be kept in mind regarding that direction.

The eastern flank could be divided in two: 1) transport via Belarus to Ukraine and elsewhere and 2) transport through Latvia and Lithuania without crossing Belarus. The eastern route through Belarus promises large cargo volumes in case of positive geopolitical situation, since it links Finland with two large and potentially growing markets, Ukraine and Turkey, while there is a highly promising connection to Turkey through Ukraine (the Odessa-Ilichovsk ports). On the other hand, risks caused by the geopolitical factors must be considered in this alternative. In principle, rail link to Ukraine is possible without crossing Belarus, but transport via Lithuania and Poland is inconvenient and slow. Fortunately, Istanbul with its environs, which concentrates a large portion of Turkey's economic potential, remains within the western route's reach. Of course, this applies to the Balkans as well.

Whether we discuss the western or eastern route of the north-south direction, the size of Finland's economy and Finland's economic interest in developing economic relations with the more remote countries of the southern direction are the factors limiting potential cargo volumes. In addition to the exchange of goods alone, this interest should include investments and intra-industrial trade. These are presumably linked not to the output of paper and timber industry, but engineering, electrical engineering and other similar type of industries. We can expect increased imports of food products from these countries to Finland. Besides Finland's own exports or imports, the channelling of transit cargo traffic across the Arctic Ocean through the ports of Helsinki and Tallinn will be another important possibility. In case of larger volumes of maritime traffic, the introduction of a rail ferry or regular container line between Helsinki and Tallinn (Vuosaari and Muuga ports) could be considered.

3.1.3. Possible impact of the Arctic Ocean transport corridor

The Arctic Ocean route presents, especially when considering continuing warming of climate, an important opportunity for transporting East Asian goods to Europe. The West-East direction must be kept in mind as well, though the Baltic Sea region's exports to Asia will remain several times lower for the coming decades. Increasing the volumes carried via the Arctic route requires the introduction of ice class container ships, which would extend the navigation period. The use of Arctic transport corridor is also indirectly connected to general economic growth and price of oil and natural gas. As the use of Arctic corridor is relatively costly, the effect of economies of scale is necessary to achieve acceptable cost level. That is related to higher demand for oil and gas and their higher price, which makes oil and gas extraction more attractive and increases transport flows giving additional impact to development of Arctic route. That makes possible to keep it longer open and to stimulate investments into supporting infrastructure (ports, security systems and rescue operations).

In order to enable the movement of the Arctic route cargoes through the Finnish ports, the Norwegian port of Kirkenes has to be linked to the Finnish rail network. Considering the amount of trade between Europe and East Asia, we are speaking of potentially large traffic volumes. The volume of the European-East Asian trade does not need to be directly linked to the state of the European economy, but it would presumably be higher in case of faster growth of Europe's economy. A problem may be posed by the fact that competition for the Arctic cargo traffic is likely to be fierce. These cargoes could be carried not only from Finland to Estonia, but also across Sweden (and via bridges and tunnels to Denmark and Germany), as well as southward across the Russian territory from Murmansk. It would be difficult to cope with that competition without the Rail Baltic infrastructure. In the future, the Helsinki-Tallinn tunnel will be important factor here as well.

In this scenario, it can be presumed that although Russia is likely to bargain for advantageous terms with the users of the Arctic route and may therefore obstruct the carriers for some time, negotiations over normal terms of using the route will eventually be successful. If the Arctic cargoes should reach Estonia and other Baltic States, it will provide a strong boost to business based on distribution centres.

3.1.4. The effect of launching Rail Baltic

This scenario estimates that Rail Baltic will be launched as planned or in any case not significantly later. Rail Baltic will bring along a principally different and more favourable situation for carrying the north-south cargo flows along the western flank of north-south direction. Long-distance rail traffic will become significantly more attractive for Finland in a very wide geographic area; according to optimistic estimates from Spain's Mediterranean ports to the Balkans and Istanbul. However, a very steep rise of cargo volumes cannot be expected; the increase would rather be gradual together with the development of the corridor's logistics (linking the Rail Baltic to the Central and Southern European transport corridors, distribution centres, et cetera). We expect that the problems of rail link to the Tallinn Muuga port cargo terminals will be solved in a technically rational way by the time the new railway has been opened.

3.1.5. Amplification between the north-south and east-west flows

The best opportunity of the Baltic States' ports, including the Port of Tallinn, would be the simultaneous handling of the north-south and east-west cargo flows. Profit from handling the east-west flows would create a basis for further investments in the common infrastructure and for creation of distribution centres. Their efficiency is the highest when handling cargoes travelling simultaneously in different directions (economy of scale effect). Secondly, the separation into two cargo flows is not absolutely necessary; e.g. a share of cargoes arriving in the Port of Tallinn from the west can move on eastwards, while a smaller amount could travel northwards or southwards.

A strategically important issue is the entry of larger container ships from Asia into the Baltic Sea. A large container ship can unload a part of its cargo in a western Baltic Sea port (e.g. Gdansk) and the other part for example in Tallinn's Muuga port. Some of the cargo unloaded in Tallinn would travel eastwards to Russia, some would be carried further along the north-west direction. The ability to receive large container carriers together with the obviously accompanying development of distribution centre

functions would accelerate the opening of regular container ship traffic between Tallinn and Helsinki and would contribute to redirecting a large share of cargos currently carried by ROPAX ships between Tallinn's Vanasadam and Helsinki's Länsisatama to the Muuga-Vuosaari route.

Although this scenario does not require a very large volume of east-west cargo to Tallinn's Muuga port, the emergence of significant amplification in the handling simultaneously and combining the north-south and east-west cargo flows is possible in case of the above conditions are met. After the launching of Rail Baltic at the latest it can be expected that a major share of the north-south (south-north) cargo traffic would be redirected to the Muuga-Vuosaari route. This also means that a part of the cargos presently carried from the Port of Tallinn towards south by road would be transported by rail.

3.1.6. Conclusions based on the scenario

We consider the launching of Rail Baltic as a precondition for the realisation of this scenario. The realisation of this scenario would see a significant increase of the Helsinki-Tallinn maritime cargo volume. The opportunity of the Port of Tallinn to become an important regional hub is possible, but it will depend on factors, such as the situation in Ukraine, the growth of Turkey's economy, the volume of cargo flow travelling by the Arctic route and its distribution between the routes of further traffic, the increase of the Gdansk port's competitiveness, et cetera. These factors may significantly vary within the same scenario and opportunities of Estonia or Finland to influence over them are minor.

3.2. Scenario 2. Business opportunities in an environment of relatively slow economic growth and uneasy geopolitical situation

3.2.1 Background

The global economic situation is somewhat less favourable than in the previous scenario, Europe's average growth rate is estimated to remain at 1 percent per year or even lower.

This scenario does not presume a major global economic crisis. Several Asian countries as well as Latin American countries and Turkey are doing fairly well. China's economic growth continues, although at a slower rate than previously. However, deteriorating economic prospects increase geopolitical tension. Relations between the EU and Russia have not improved, the situation of Ukraine will remain a long-term problem. Russia is nervous about the falling energy prices in the world market, which threatens to turn its economic growth rates negative for a longer period. Russia has succeeded in creating the Eurasian (Economic) Union, but it suffers from considerable tension as the Central Asian member countries are more attracted to integrate with China and the rest of Asia rather than with Russia. Since the strategic trajectory of development spells nothing good for Russia, it is more interested in creating international tensions, which could lead to increasing energy prices, rather than in reaching an agreement with the West over common rules of game.

The West has decided that Ukraine would not be allowed to fall back under Russian domination and it must gradually move towards closer economic integration with the EU. However, this requires extremely large resources from the already economically strapped EU and limits its opportunities for

other undertakings. As for energy issues, the EU sits between two chairs. On the one hand, the motivation to reduce energy dependence on Russia is by political motives stronger than in the previous scenario. On the other hand, the opportunities to realise this policy are more limited.

Since both the EU and the Eurasian Union are weaker than in the previous scenario, it can be expected that they cannot keep up their row indefinitely, and at some point, they will have to reach an agreement on certain rules regarding their trade. However, the agreement will be more protectionist than in the previous scenario. This may also concern granting an access to the rail network.

The world economy would not return to its earlier protectionist practice concerning trade between the countries, but there may be significant protectionism in the use of natural resources and control over infrastructure. The EU will not disintegrate, but the limited resources do not allow it to make vigorous proactive moves to change the situation. It attempts to continue the previous strategies including the development of an integrated transportation network, but the realisation of the projects tends to be delayed.

Ecological goals are pushed to the background due to the deteriorating economic situation. As there are no strong polices for changing of transport modes, no possibilities for big investments into transport infrastructure or subsidies and no significant pressure to sea transportation from cost side (the price of oil is low, not more \$ 60 per barrel and because of it the impact of sulphur directive is not very strong), the competitive position of railway transport versus sea or road transport is somewhat weaker than in the first scenario.

3.2.2. Demand for north-south (south-north) cargo traffic

While the economic stagnation in Europe as a whole will slow down trade and cargo volumes, the area extending from the Baltic States and Poland to Balkans and Turkey may be in a somewhat better state than so-called old Europe. Although the latter's deteriorating capability will affect the eastern regions, these less expensive countries can somewhat benefit from old Europe's problems, e.g. by increasing subcontracting. It is questionable within this scenario, whether they can also benefit from Europe's continued or closer economic ties with Asia (China, Japan and South Korea). Russia's refusal to cooperate may be one of the obstructing factors. It is not just about Russia's behaviour as a transit country of transcontinental traffic, but also about its probable refusal to use the border countries' (e.g. Estonia's) ports for receiving East Asian cargos.

It can be presumed that Finland's economic growth in this scenario will be lower than in the previous scenario, but this does not automatically mean that Finland's north-south flow of exported and imported goods should not continue growing. With the low economic activity of the 'old European countries', Finland should be even more interested in entering new markets. The problem is the instability of essentially promising markets, such as Turkey and Ukraine, in a tense geopolitical situation. It is possible that Finland is also interested in imported goods from these regions, e.g. cheaper food products from Ukraine. The problem here is whether Finland is willing to take risks of investing in these countries, which could lead to significant increase of trade, or will it be content with lower-risk economic relations (trade and subcontracts).

When comparing the different north-south transport routes in case of stagnating European economy, the eastern route across Belarus would be economically more promising. Since the scenario's characteristic is tense relations with Russia, it can be presumed that this perspective would not be realised. Presuming that the Ukraine-related traffic, including to Turkey, is important in this scenario and the likelihood that Russia's attitude makes it impossible to use the Belarus route, there is a theoretical possibility of the construction of a railway link from Lithuania via Poland to Western Ukraine with EU support. Effectively that would be an eastern stretch to Ukraine of the future Rail Baltic. However, the realisation of this idea in relatively cramped economic circumstances cannot be considered likely.

It is possible that rail transport will lose volumes to the cheaper maritime traffic in hard times. The relaxing of ecological standards for the sake of lower costs and economic growth will in turn favour road transport for this direction traffic.

3.2.3. Possible effect of the Arctic Sea transport corridor

It can be presumed that tension between the EU and Russia, the slow growth of the European economy and even the decreasing inter-EU trade will not reduce the potential significance of the Arctic shipping route. Europe in its economic stagnation may be even more interested in finding new export markets in Asia and possibly in importing at least some cheaper goods from East Asia in order to replace imports from other EU countries. In a geopolitically tense situation, where even the closing of the Suez Canal cannot be ruled out, the importance of the Arctic route may increase further. Russia in turn may use the Arctic route for blackmail as the ships would have to pass through its territorial waters. This will significantly slow the launching of the full potential volume of the Arctic shipping route. Besides political factors, the launching of Arctic corridor is also connected to general economic growth and price of oil. It is quite a costly enterprise, and if there is no big interest, especially common interest between Russia and Western countries to start extracting oil and gas in the Arctic region, the stimulus to develop transport route will be much weaker as well. Of course, powerful China, which is interested in shipping of its goods to Europe may exercise a pressure to speed the process up.

Opening the shipping route will obviously require investments from the European side, e.g. ordering ice class container ships from shipyards, expanding the Port of Kirkenes and other ports, linking them with the southbound railway network, et cetera. If Europe's economy should face serious stagnation before making these investments, their postponement may be unavoidable.

If Russia's economic situation was good in this scenario, it could partly for political motives accelerate the construction of the Port of Murmansk and the southbound transport channel in order to direct as much as possible of the Arctic route traffic to the south over its territory. However, this option would not significantly harm the prospects of the Helsinki-Tallinn maritime route due to the limited overlapping of catchment areas. Besides, there is no serious ground to presume that Russia's economy could afford major investments in the near future. The transport of cargos arriving in Kirkenes to 'mainland Europe' over Sweden's territory could be viewed as more likely competition.

3.2.4. The impact of launching Rail Baltic

Principal importance of Rail Baltic in this scenario is not lower than in the previous scenario, rather the opposite. A tense geopolitical situation will amplify its strategic (in the security and foreign political sense) importance. Since this is an internal route of the EU, Russia lacks any practical means to obstruct its construction. On the other hand, the complicated financial situation may delay the construction of the railway line for a few years when compared to the previous scenario.

There is also reason to expect that the growth of cargo volumes carried by the railway would be slower than in the previous scenario due to the economic stagnation in Europe. From the perspective of growth opportunities in the Helsinki-Tallinn maritime transport, the role of Poland, its northern and western parts in particular, should be considered. It cannot be ruled out that Poland's economy is able to continue growing even when Europe's economy as a whole is stagnating. Here, it needs to be stressed that maritime transport is a very competitive option to railway in traffic between Finland and Poland.

Maritime competition should also be considered regarding the traffic between Finland and Germany. The size of the German economy and opportunities related to Germany should be kept in mind. Even a very small percentage growth in Germany-related cargos can significantly boost the volume of maritime traffic between Helsinki and Tallinn.

3.2.5. Amplification between the north-south and east-west cargo flows

The amplification effect is significantly weaker in case of the second scenario as compared to the first one. First, it can be expected that in case of geopolitical tensions Russia will attempt to starve out the Baltic States' ports from the east-west traffic. Secondly, the prospects for importing large volumes of cargo through the Baltic States' deep-water ports with the expectation to consume a part of the goods in the region and to carry the rest to Russia deteriorate. In case of a geopolitical conflict, Russia has unlimited opportunities for creating major obstructions to the transport of goods over its borders or making it downright impossible. It is more likely that Russia will spend huge sums on dredging the Port of the Ust-Luga to establish it as the eastern destination of large container ships entering the Baltic Sea. This could harm the prospects of opening a dense-traffic container route between the Tallinn's Muuga and Helsinki's Vuosaari ports. Cargo traffic across the Gulf of Finland will continue with passenger servicing ROPAX ships and between the Helsinki's Länsisatama and Tallinn's Vanasadam both located in the city centres rather than the route between cargo ports of Helsinki's Vuosaari and Tallinn's Muuga.

As the rapid development of distribution centres in the Baltic States would require economy of scale, i.e. an opportunity to handle both north-south and east-west cargos simultaneously, this process will slow down.

3.2.6. Conclusions based on the scenario

The economic growth in Europe and global interrelationships, especially between the EU, Russia and China, are critical factors in the creation of new transport corridors. The weaker economic growth and

BSR Policy Briefing 1/2016

lower oil price will make the creation of north-south / south-north transport corridor more difficult. However, the launching of Rail Baltic is highly probable also in the conditions of this scenario, at least because of strategic considerations. Finland's interest in economic southward expansion may be even stronger addressing long-distance traffic related to this route. This will create additional cargo flow on the Helsinki-Tallinn maritime route. Because of weaker economic growth in EU countries, the perspective to get additional cargo is only moderate at best in the catchment area of the corridor's western flank. It could be potentially higher in the catchment area of the corridor's eastern flank, including Turkey, but this region may witness considerable (geo)political tension in case this scenario should be realised. A problem related to this scenario could be the delay of necessary reorganisations concerning maritime traffic logistics across the Gulf of Finland (container ship traffic between the ports of Helsinki's Vuosaari and Tallinn's Muuga or the introduction of a rail ferry). The potential additional demand for transport may be too small to justify the investments needed for these innovations (the issue of critical mass).

Baltic Sea 2030 – Trends and scenarios

Heikki Liimatainen

Executive summary

The current Baltic Sea logistics system is a result of an optimisation process by industry, ports, shipowners and other stakeholders, all adapting to changes in the operating environment and building strategies for the future. As a result of this process we see the current logistics system, but the parameters of the optimisation process are changing constantly. Global directions of change are called megatrends and common megatrends include: globalisation and increasing importance of Asia, global political issues but national interest, rising energy demand and increase in alternative energy sources, climate change, increasing pace of technological development and urbanisation.

In this study, five trend categories were identified based on the megatrends and considered in terms of their effect on the Baltic Sea logistics system. The trends were also analysed by their significance and affectability by maritime sector in order to give the actors a better understanding of the trends which may and should be affected.

Four scenarios were build based on the trends. **The age of growth** scenario is characterised by steady economic growth, growing importance of service sector and restoration of trade between Russia and Europe. **The age of regulation**, on the other hand, is defined by slow economic development due to strict environmental regulation and lack of innovations in heavy industry. **The age of locality** could be sparked by rapid climate change which would lead to high price of energy and resulting halt in global trade. **The age of change** would be possible if technological innovations enable rapid transition to renewable energy and Russia integrates closely to Europe as its energy resources lose its geopolitical significance.

The actors may take one of these scenarios and begin to work actively towards it or take another and work against it. Actors may also build their own scenario as a new combination of the factor values presented in the futures table in this article

1. Introduction

Navigare necesse est. This report is full of reasons why to sail truly is necessary, especially for Finland. The Finnish economy is practically entirely dependent on maritime transport on the Baltic Sea and the hinterland connections of the ports. The lifelines of Finnish trade are the shipping routes with German, Polish, Belgian and Dutch ports with the ferry routes with Sweden and Estonia. Finnish ports are also an important transit gateway to Russia.

The current Baltic Sea logistics system is a result of an optimisation process by industry, ports, shipowners and other stakeholders, all adapting to changes in the operating environment and building strategies for the future. As a result of this process we see the current logistics system, but the parameters of the

optimisation process are changing constantly. In order to be prepared for the future changes and, when possible, to affect the direction of change, envisioning the future of the Baltic Sea logistics system is necessary.

This article is a result of an envisioning process carried out by the Transport Research Centre Verne for the Finnish transport authorities as a background for the Finnish maritime strategy. The aim of this process has been to identify the most important factors affecting the Baltic Sea logistics system, forecast the trends of these factors and define future scenarios resulting from different combinations of these factors.

2. Envisioning process

The scenario building process began with identifying the megatrends and preconditions which set the scene for the future of the Baltic Sea logistics system (Figure 1). Then an environmental scanning process aiming to identify the most important factors affecting the future was carried out. Environmental scanning was based on a series of interviews of Finnish maritime transport experts from business, academia and authorities.

Figure 1. The scenario building process

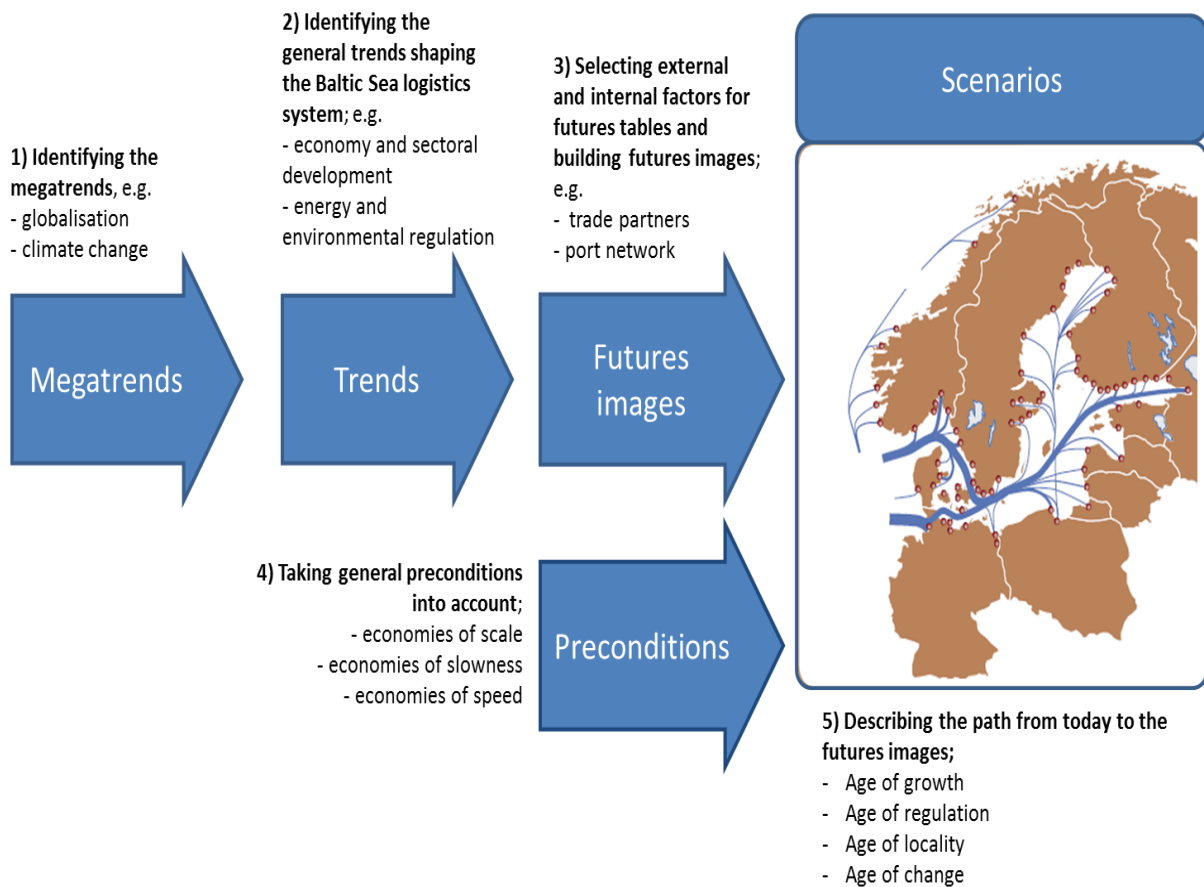

Source: Adapted from Mäkelä et al. (2011).

BSR Policy Briefing 1/2016

After the factors were identified, a workshop was organised to assess the importance and affectability of the factors. Also some directions of change of the factors were identified in the workshop and later used in the scenario building.

The most important and interesting factors were then chosen for the scenario building process which began with compiling a futures table. The factors in the futures table were classified as external or internal, based on the affectability of the factors, i.e. the external factors are wide issues which the Finnish maritime sector can affect very little whereas the internal factors can be affected. Four futures images for the year 2030 were build using the futures table and development from current state to the futures images were described, resulting in four futures scenarios.

3. Megatrends

Baltic Sea logistics system is a part of an ever-changing global system. Global directions of change are called megatrends. These are long term changes within which there are smaller trends which mainly have similar effects, but also conflicting trends can be found. Megatrends have been identified in various futures studies and common megatrends include (DNV 2010; EEA 2010; Wärtsilä 2010; Valli 2011;):

- Economy: globalisation and increasing importance of Asia;
- Politics: global issues vs. national interests;
- Energy: rising demand, increase in alternative energy sources;
- Environment: climate change, emission regulation and reduction targets, sustainable use of natural resources;
- Technology: internet of everything, increasing pace of development; and
- People: urbanisation, aging population.

The megatrends also have an effect on the maritime sector. Globalisation and increasing importance of Asia has been seen in offshoring production from Europe to Asia but also within Europe from Western Europe to Eastern Europe. This is reflected in the Baltic Sea logistics system as an increase in transport via Russian, Polish and the Baltic States' ports. Separation of points of production and consumption also cause imbalance of freight flows both globally and within the Baltic Sea.

Economic changes also affect the political processes. There are signs that the free trade development is changing towards protectionism. Prolonged financial crisis, especially in Europe, has increased the importance of national interests, even though global challenges such as climate change, terrorism and refugees would require global co-operation.

Environmental megatrends have a strong effect on maritime sector as the requirements for energy efficiency and emission control of vessels increase. In the Baltic Sea, the most important change has been the transition to low sulphur fuels. On long-term climate change is forecasted to decrease the Arctic ice cap, opening the Northeast Passage for transport between Asia and Europe and also enabling the use of Arctic natural resources. Climate change mitigation by reducing the carbon dioxide emissions may lead to a carbon emission trading in maritime sector. It may also lead to a bunker fee, reduction of energy use and increasing use of alternative energy sources. Furthermore, construction and maintenance of alternative energy facilities, such as offshore wind energy, require new logistics solutions.

BSR Policy Briefing 1/2016

Technological demographical changes affect the consumption and hence the freight flows. Social media creates rapidly global phenomena which may alter the demand of certain products very quickly. Online shopping changes the logistics systems and increases the importance of speed in supply chains. Urbanisation affects the positioning of logistics nodes and increases the importance of city logistics. It may also affect the ports which are located within or near cities as the city grows. Finally, aging population may make it difficult to find workforce to logistics.

4. Logistical preconditions

Even though the world and maritime logistics are under constant change, some issues are fixed and create the preconditions to changes. Such issues include, for example, the basic qualities of different transport modes. These basic qualities are the speed of transport, capacity and accessibility, as well as the transport costs which result from these. In terms of accessibility road transport is by the best and thus part of virtually every transport chain. In terms of speed air transport is in the league of its own on long distances but because of capacity there is no alternative for maritime transport for many products. Large capacity also means low costs per unit, further increasing the competitive advantage of maritime transport.

Between, and also within, transport modes there are three precondition which affect the logistics system also in the future. These are economies of scale, economies of slowness and economies of speed (Figure 2).

Figure 2. The logistical preconditions

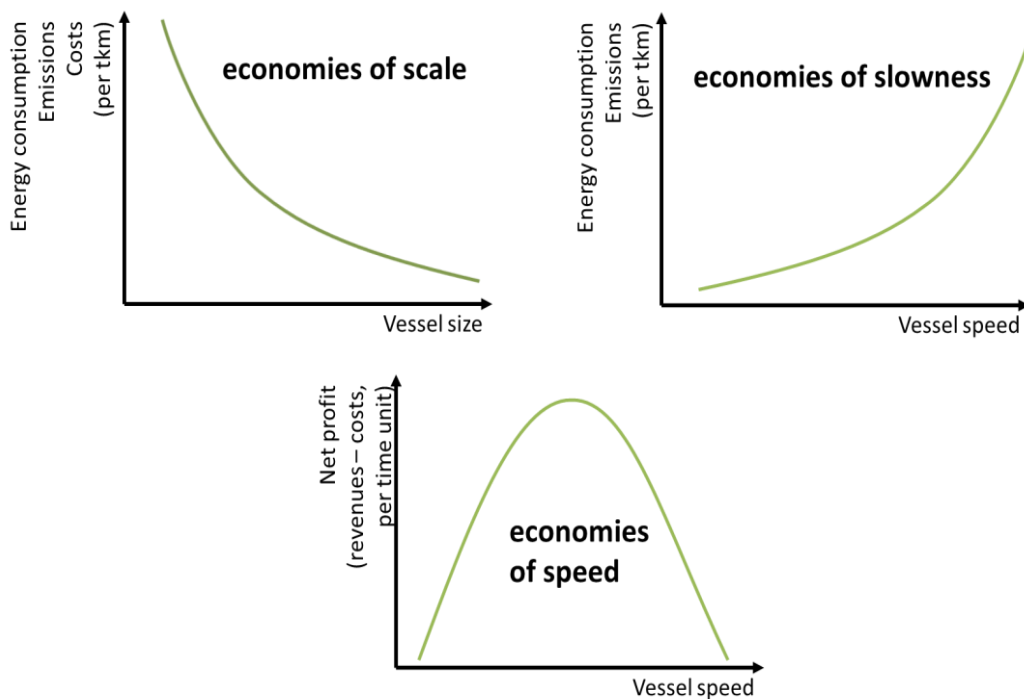

Source: Adapted from Kallionpää et al. (2013).

BSR Policy Briefing 1/2016

Economies of scale means that the transport costs per unit decrease as the size of the vessel increases. This is because the need for workforce and fuel per unit decrease. Also the emissions decrease as fuel consumption decreases. Economies of slowness means that the fuel consumption and emissions decrease as the speed decreases. However, as the travel time increases the employment costs increase. On the other hand, if speed is increased, more transport can be made within the same timeframe which increases the revenues. Hence, there is the economies of speed and the net profits reach the maximum at a certain optimum speed.

The optimum based on economies of scale, slowness and speed can be altered by various efficiency improving measures, such as:

- maximisation of the size of vessel;
- maximisation of the utilisation rate;
- minimisation of energy consuming properties (aerodynamic and hydrodynamic drag, engine and transmission losses); and
- minimisation of loading time.

The logistical preconditions are especially important in maritime transport because the variability in vessel sizes is large and hydrodynamic drag is strongly related to the speed of the vessel (Psaraftis et al. 2008, 2009; Klanac et al. 2010; Levander 2011). The optimisation of maritime logistics has been seen in increasing sizes of container vessels, automatization of cargo handling and slow steaming as measure to adapt to decreased demand during financial crisis.

5. Trends

The future of the Baltic Sea logistics system is formed as a result of a number of trends, all of which cannot be covered here and may not have been identified at all during this process. However, some trends identified based on interviews with Finnish maritime experts are presented here. The results include some issues which are specific to Finland, but also general trends applicable around the Baltic Sea. The trends have been classified into the following five categories:

- 1) economy and sectoral development;
- 2) energy and environment;
- 3) logistics practices;
- 4) infrastructure and transport routes; and
- 5) port network and shipowners.

5.1. Economy and sectoral development

Maritime transport is at its best a highly efficient transport mode which captures the benefits of the economies of scale. Hence, maritime transport will remain as the primary export and import mode for Finland. The importance of maritime transport has also been acknowledged in the EU policy, but it has also been seen that some regulations may not affect all member states equally. Also other regulations, such as the ones made within IMO may have regional effects particularly in the Baltic Sea. An example of such regulation is the sulphur emission control area (SECA).

BSR Policy Briefing 1/2016

Changes in the importance of various sectors of economy are likely to continue. Conflicting opinions have been said about the future of the Finnish forest industry, but it is seen likely that it remains a major transport generating sector in Finland. The product mix is, however, likely to change from printing papers to cellulose and bioenergy. An example of this change is the new cellulose plant in Äänekoski currently under construction for Metsä Fibre. Overall, the demand for forest related export transport may even increase by 2030.

Metal industry is seen to be less prone to changes, because of the nature of products manufactured in Finland and large clusters around current manufacturing sites. Mining sector is seen to increase in importance, even though the global mineral prices have a strong effect on mining decisions. However, once a mine is opened, it is usually kept in production despite of market fluctuations.

Global economic development and particularly the economic development of Russia are interesting and highly significant for the Baltic Sea logistics system. Russia is a huge market for consumer products, many of which are mainly shipped via Baltic Sea ports. The current low oil prices and trade embargos have had significant effect on transport demand, but the normalisation of trade may lead to significant increase in transport by 2030.

5.2. Energy and environment

Global climate change and growing environmental concerns are drivers towards strict environmental regulations and increasing demands for energy efficiency. The climate agreement achieved in Paris in December 2015 sets the guidelines for carbon dioxide emission decreases although precise emission targets were not agreed upon. International maritime emission regulations are made in IMO, but coastal shipping emissions are included in the national emission inventories and regulation of coastal shipping may have an effect on international shipping. Emission regulations are a challenge to maritime sector because the lifetime of a vessel is very long and alterations may have to be made to comply with new standards. On the other hand, this creates new business.

Baltic Sea is a SECA area and implemented the regulation of low sulphur maritime fuels in 2015. In order to meet the new regulation shipowners had basically four options: start using new vessels with possibly LNG, modify current vessel with sulphur emissions reduction equipment, use marine diesel or stop operating ships within the area. All these options were seen to increase the transport costs. However, the crude oil prices have simultaneously decreased significantly and partly offset the extra costs. Because of this, the full effects of SECA remain to be seen. It is expected that there may be some changes to other transport modes where possible. It is also seen that SECA may have an effect on hinterland connections, because increasing use of marine diesel increases truck diesel prices.

Environmental regulations also open new opportunities for alternative fuels. Liquefied natural gas (LNG) is seen as the most promising alternative for shipping and LNG powered passenger ferry Viking Grace is already in operation between Finland and Sweden. Dual fuel engine technology is seen to be dominant in the future. Also electric ferries are seen to have some potential on short distance routes. Furthermore, the energy efficiency design index (EEDI) and upcoming similar regulations are seen to affect ship design in the future. These may lead to lower speeds and smaller engines, which may affect the operations during winter if the ships do not have enough power to operate in ice.

5.3. Logistics practices

Changing the physical locations within global supply networks to meet changes in demand is rather slow and expensive. Improving the logistics operations through horizontal collaboration is seen more likely. Consolidation of freight flows and logistical partnerships between companies are likely to increase.

Within the transport sector the importance of different cargo handling systems may change. Globally, containerisation of goods has been the dominant trend, but in Europe trailers have remained important. Containers may increase their share if break bulk goods are increasingly shipped in containers, but these changes are not expected to be very significant by 2030.

The imbalance between the demand and supply of empty containers is seen to remain an issue in the future, especially if the Russian import of consumer goods is re-opened. These goods are mainly imported in containers but Russia exports very little containerised goods, which creates a supply of empty containers at low prices to ports near Russia.

5.4. Infrastructure and transport routes

As stated above, it is possible that the sulphur emission regulations and an increase in oil price could change transport mode choices by 2030. Transport infrastructure improvements, particularly rail infrastructure such as Rail Baltica, will have an effect, but may not be ready by 2030. There are also visions of extending Rail Baltica to Helsinki via a tunnel across the Gulf of Finland. However, the capacity of rail transport is limited even with new connections and maritime transport remains the dominant mode.

5.5. Port network and shipowners

The most important challenge shipowners currently face is weak profitability because of decreasing revenues due to financial crisis and increasing costs due to sulphur emissions regulations. Weak profitability affects shipowners' possibilities to make investment and prepare for future challenges.

Ports will have to make their operations more efficient either through specialisation or through economies of scale. Urbanisation is likely to centralise freight flows to fewer general ports but small ports may keep their competitive advantage through specialisation to serve certain sector. It is seen that the number of ports around Baltic Sea is likely to decrease by 2030.

6. Can maritime sector and transport policy affect the trends?

Some of the trends mentioned above are such that they cannot be affected by the maritime sector or transport policy, whereas some can be affected very much. A workshop was held where Finnish experts assessed the affectability and significance of various trends. The results are presented in Figure 3. The positioning of the trends in Figure 3 is not absolute but rather in relation to other trends. It can be seen from Figure 3 that Finnish economic policy, port related infrastructure and decision on taxes, fees and subsidies have a strong effect and are also in control of Finnish maritime sector and policymakers.

Figure 3. The affectability and significance of some trends

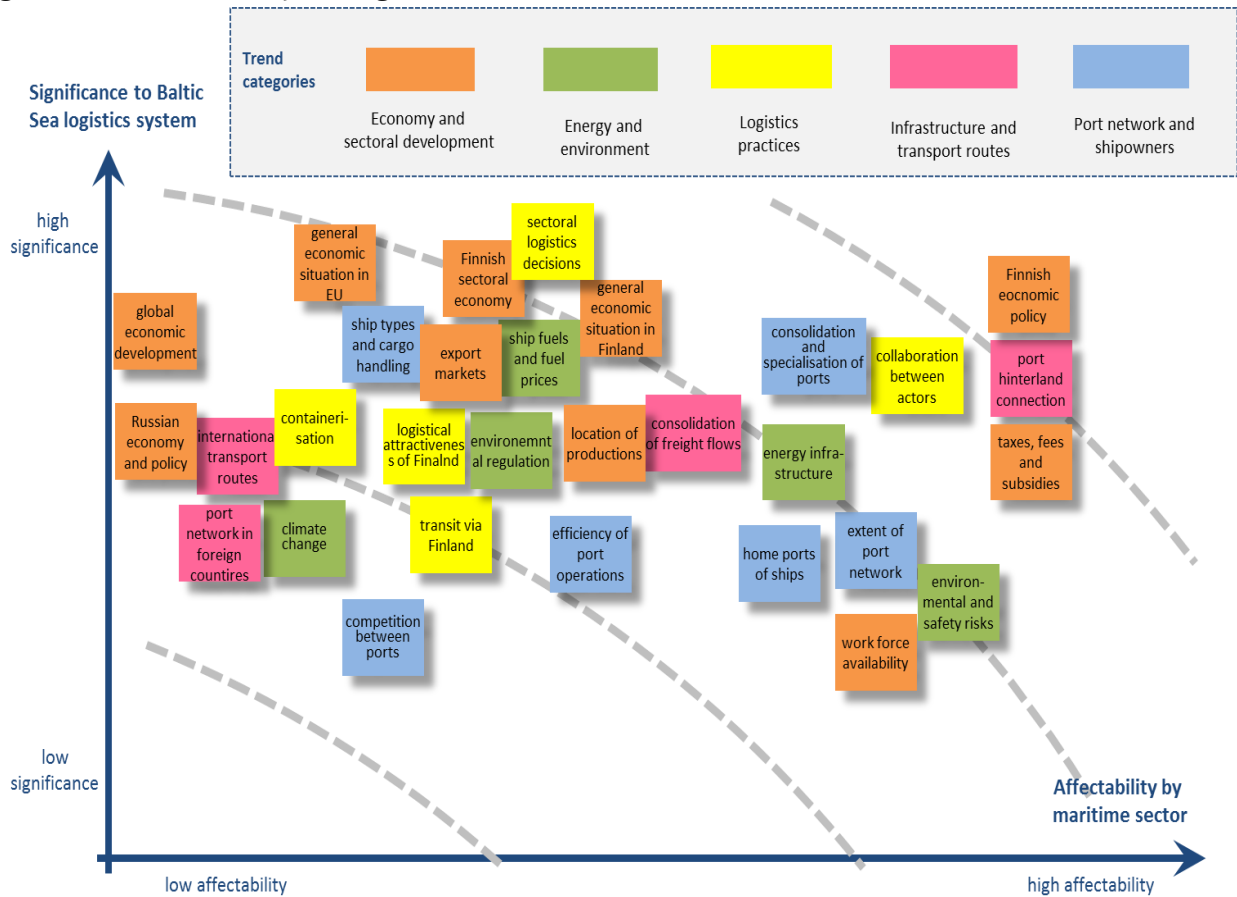

Source: Adapted from Kallionpää et al. (2013).

7. Futures images and scenarios

The scenario method is possibly the most well-known futures studies method. A scenario is an informal and insightful narrative of a possible future (futures image) and the path which leads there from current state. Scenarios should not be assessed by how well they are fulfilled but rather by how well they can now be used in decision-making. (Rubin 2002.)

There are commonly four types of alternative futures considered in scenarios (Dator 2012):

- 1) continued growth;
- 2) collapse (from one or more reasons);
- 3) discipline (on the basis of certain values); and
- 4) transformation (to a vaguely-perceived new socio-environmental system).

Applying these basic types, four scenarios for the Baltic Sea in 2030 were built. These scenarios are called:

- 1) age of growth;
- 2) age of regulation;
- 3) age of locality; and
- 4) age of change.

7.1 Futures images

The four futures images are presented here using two futures tables. First futures table present the external factors affecting the maritime sector and the second presents the internal factors, which can be more easily affected. Both futures tables have the factors in the first column and the values for each factor are presented in columns for each scenario.

7.1.1. External factors

Six external factors were chosen to be included in the first futures table. The overall and sectoral economic developments in Finland are the first two factors. These affect the demand of maritime transport and the types of products shipped. A prolonged economic downturn or sustained recession, caused maybe by high price of energy, would lead to a completely different future for maritime sector than a steady growth of economy. Overall economic development is a result of sectoral development and depending on the global demand the Finnish transport intensive export industries may thrive or struggle.

Maritime sector has to adapt to the changes in export markets. If Finnish exports and imports with Russia return to previous levels and increase, road and rail will become more important transport modes. Also the development of trade with growing economies in Asia, South America and Africa affect the maritime sector.

Environmental regulations are partly affected by the influence Finland, but a single country has limited influence on the IMO and EU level decision-making. Environmental regulations and the price of energy may change significantly by 2030. The price of energy depends on the global demand derived from economic development, but the costs of different sources of energy are also heavily affected by regulations, fees and subsidies. Based on expert opinions and the views of the research team, the following values were considered likely for the external factors in the four scenarios (Table 1).

Table 1. The futures images of external factors

	Age of growth	Age of regulation	Age of locality	Age of change
Finnish economy	steady growth	slow growth	no growth	rapid growth
Finnish sectors	service sector and mining increasingly important	heavy industry reduced significantly	agriculture and bioenergy increased	strong industry with several new technologies
Trade partners	intra-Europe most important	Far East and Africa most important	mostly neighbouring countries	Russia most important
Russian economy and policy	significant trade, especially in energy	Russia in recession	Russia important only to neighbouring regions	strong integration with Europe
Environmental regulation	European special regulation areas	global, strict and binding regulation	global CO ₂ -emission quotas with high price	global, strict and binding regulation
Energy and ship fuels	moderate increase of price, some use of biofuels and LNG	price at current level, LNG dominant	high price, mostly fossil fuels with some biofuels	cheap renewable energy, several alternative energy sources

Source: Adapted from Kallionpää et al. (2013).

7.1.2. Internal factors

The futures table of the internal factors also includes six factors. Horizontal collaboration may not develop from current state and every company looks after its own interest, but it is possible that long-term strategic partnerships are developed. Partnerships may also occur regionally between actors in different countries.

Investment abilities of shipowners and ports are largely dependent on general economic development and more specifically on changes in the demand for maritime transport. In a good economic situation the demand increases and many actors have possibilities for investments whereas in an economic downturn investment abilities decrease. Generally, weak profitability and highly competitive market may hinder investments whereas steady and predictable competitive environment may enhance the shipowners and port operators ability to invest and renew.

Demand and consolidation of maritime transport depend on the changes in external and internal factors. Generally in declining market consolidation increases because of efforts to maintain profitability. In a steady or growing market there may not be a need for consolidation, but external factors, such as environmental regulation, may increase costs and lead to consolidation.

The development of ship sizes and types, cargo handling equipment and containerisation are also mainly dependent on external factors such as sectoral economic development and the price of energy. However, this development is also internally affected and changes may occur due to consolidation or technological innovations.

The port network may well be quite different in 2030 than it is today, depending on both external and internal factors. If the economic development prefers reshoring of production and local economy, the port network is likely to consist of regional general ports. Consolidation and investment opportunities may lead to a network of specialised ports and large general ports which serve a large hinterland.

The development of trade and transport routes is also affected by several external and internal factors. Trade areas, transport costs, infrastructure development and organisational partnerships affect the transport routes by 2030. Rapid climate change may open the Northeast Passage and the political situation affects the opportunities of using it and more generally the demand of Russia related transport on the Baltic Sea.

Based on expert opinions and the views of the research team, the following values were considered likely for the external factors in the four scenarios (Table 2).

Table 2. The futures images of internal factors

	Age of growth	Age of regulation	Age of locality	Age of change
Collaboration between actors	some collaboration to gain financial benefits	long-term vertical collaboration	local collaboration	strategic horizontal and vertical partnerships
Investments by shipowners and ports	steady investments	investments to comply to regulation	low investment ability, focus on energy saving	strong investments to renewable energy
Demand and consolidation of maritime transport	demand at current level, strong consolidation	reduced demand, strong consolidation	radically reduced demand, very strong consolidation	increased demand, some consolidation
Ships and cargo handling	containerisation	large ships, low frequency, slow-steaming, less bulk goods	multi-purpose ships	specialised ships, increased coastal shipping
Port network	large specialised network	few large general ports	regional general ports	large specialised network
Transport routes	increase in land transport	current routes	few routes, some new northern routes	new Russian routes and rail connections

Source: Adapted from Kallionpää et al. (2013).

7.2. Scenarios

7.2.1. The age of growth

The defining factors of this scenario are relatively fast economic growth, increasing importance of service sectors and high value industries and increasing trade between Russia and the EU. The demand of maritime transport remains around current level but the value of cargo increases and containerisation is widespread.

In the age of growth scenario the Finnish and European economy have returned to growth path although the price of energy restrains the growth. Production of high value goods increase and service sector is responsible for a greater portion of GDP. New mines and related industry have been opened in Northern Finland.

European trade have remained as most significant for Finland and exports are transported mainly to the Baltic Sea area. Imports, on the other hand come increasingly from outside Europe, particularly South America and Africa are increasingly important. Russian trade has also regained its importance.

Environmental regulations have become more stringent globally. North Sea and Baltic Sea remain as areas of even stricter regulation. The EU acts as a driver for environmental regulation and may implement regulation even without IMO. In addition to environmental regulation, safety and security regulations become increasingly important and these aspects are also a matter of corporate image and social responsibility.

The price of energy rises moderately as the increasing demand for energy is provided using renewable energy sources. Within the maritime sector, biofuels and LNG have become viable options.

BSR Policy Briefing 1/2016

Consolidation and strategic partnerships have been developed in order to meet the challenges of environmental regulation and energy price. The economic growth has enabled investments of shipowners and ports and early adopters of new technology have gained competitive advantage.

The overall demand of maritime transport has not increased although the value of goods has. The cargo is increasingly containerised and some ports have specialised. The high price of hinterland transport by road due to increased price of energy benefit ports with rail connections but also prefers short inland transport and thus wide port network. Rail connections between Finland and Sweden as well as Russia have been improved and are used widely especially by the new mining industry.

7.2.2. The age of regulation

This scenario is defined by strict and globally binding environmental regulation, slow economic development, decrease of heavy industry and increasing importance of Far East trade. As a result of the decrease of heavy industry the demand for maritime transport has decreased significantly and remaining freight flows are highly consolidated to few general ports. Both horizontal and vertical long-term collaboration have been developed to cope with the changing competitive environment.

In the age of regulation scenario the economic development of Finland and Europe is slow. The economic development of China and other developing economies slowed down in the late 2010s, which lead to global downturn and Europe lost its competitive edge because of high employment costs and aging population. Heavy industry has been significantly reduced as a result.

Political issues with Russia prolong and trade with Russia is very. Russia is still largely dependent on the export of natural resources and energy, but the trade is mainly with China and other Asian countries. Finnish trade is also increasingly with Asian countries and exports consist of knowledge intensive sectors whereas imports are transport intensive.

The environmental regulations are strict and globally binding. This increases the transport costs globally. LNG and biofuels are widely used to meet the regulations even though the price of energy has not increased because of low global demand. Environmental responsibility guides also the investments of shipowners and ports.

Freight flows are highly consolidated due to decrease in overall demand and this has led to strategic partnerships both horizontally and vertically. Economic policy focuses on maintaining a predictable long-term operating environment. The volume of bulk goods transport has decreased significantly in the Baltic Sea as the result of both decrease in heavy industry production and decrease in oil transport from Russia. The port network consist mainly of a few large general ports.

7.2.3. The age of locality

This scenario is defined by rapid climate change and resulting strict and globally binding greenhouse gas emission regulation which leads to very high energy price. As a result the economic development

BSR Policy Briefing 1/2016

transforms from globalisation to localisation. The demand for maritime transport decrease heavily and transport is consolidated to a high degree.

In the age of locality scenario the economic development has halted both in Finland and globally. The global climate change developed rapidly in the 2020s and widespread mitigation and adaptation measures affect global economy. Fossil energy is being abandoned and the development of renewable energy increases the price of energy significantly. Also in the maritime sector biofuels and biogas are mainly used.

Environmental regulations are very strict. Greenhouse gas emissions are regulated and the price of emission quotas is very high. Decreasing the emissions is a particularly demanding challenge to countries which previously had high per capita emissions.

Local economies based on local natural resources and renewable energy sources have become the most important aspect of economic development. This has led to significant decrease of foreign trade and maritime transport. Also the co-operation of actors happens mainly at local scale.

The demand for maritime transport has decreased significantly and remaining transport is highly consolidated. Shipowners and ports have very little investment opportunities and the investments are solely focused on improving energy efficiency and decreasing GHG emissions. Consolidated freight flows are shipped using multi-purpose vessels which can carry containers, ro-ro and bulk. Local economies are served with a network of few general ports. Global maritime transport uses increasingly the northern sea routes opened by climate change.

7.2.4. The age of change

This scenario is defined by economic growth, the low price of renewable energy, global environmental regulation and strong integration of Russia and Europe. Maritime transport demand increases and strong economic development in a variety of sectors maintain large network of specialised ports.

Economic growth is fast in the age of change scenario because of low price of energy. Technological breakthroughs in the production and storage of renewable energy, together with energy saving technologies, ensure a quick transition to low carbon economy.

Finnish economy is strong and there are several important sectors which require both export and import on Baltic Sea. Russia is the most important trade partner to Finland and Russia has integrated strongly with Europe through extensive economic collaboration.

Environmental regulation is global and same regulations are used in developing countries as in Europe, which has given Europe technological advantage. New renewable energy technology is cheap and also ships have various alternatives for energy.

The economic environment allows shipowners and ports to make large investments and the investments are mostly directed at implementing renewable energy and specialising cargo handling equipment to serve specific sectors efficiently. Specialisation is further backed up with strategic partnerships both horizontally and vertically.

The demand for maritime transport has increased and there has been some consolidation of freight flows because of partnerships and specialisation. Transit via Finland to Russia has also increased. The port network is extensive and specialised. Ports have also developed new business to add value to mere cargo handling. Coastal shipping has increased and hinterland rail connections are important.

8. Conclusions

Identifying different possible futures is important as it gives the actors the opportunity to consider what they can do to avoid unwanted future and adapt to likely changes which they cannot affect. This article has described some important trends affecting the external and internal factors of the Baltic Sea logistics system, various possible future images and scenarios.

All relevant trends affecting the future of maritime transport should be considered when preparing for the future. In this study five trend categories were identified and considered. The trends were also analysed by their significance and affectability by maritime sector in order to give the actors a better understanding of the trends which may and should be affected.

Four scenarios were build based on the trends. The age of growth scenario is characterised by steady economic growth, growing importance of service sector and restoration of trade between Russia and Europe. The age of regulation, on the other hand, is defined by slow economic development due to strict environmental regulation and lack of innovations in heavy industry. The age of locality could be sparked by rapid climate change which would lead to high price of energy and resulting halt in global trade. The age of change would be possible if technological innovations enable rapid transition to renewable energy and Russia integrates closely to Europe as its energy resources lose its geopolitical significance.

The actors may take one of these scenarios and begin to work actively towards it or take another and work against it. Actors may also build their own scenario as a new combination of the factor values presented in the futures table in this article. Should some actors do this, the scenarios have served their purpose, for the scenarios should not be assessed based on whether they actually come true, but rather based on the level of understanding about the possible futures and the activities aiming at shaping the future. Navigare necesse est, also in the future. But what kind of sailing, that is up to us.

References

- Dator, Jim. 2012. Dream Society? Ubiquitous Society? No Society? Futures for Finland and the world as seen from a small Pacific Island. *Futura* 3/2012, pp. 38-42.
- DNV. 2010. Technology outlook 2020. [http://issuu.com/dnv.com/docs/technology_outlook_2020_lowres].
- EEA. 2010. The European environment – state and outlook 2010. Assessment of global megatrends. [<http://www.eea.europa.eu/soer/europe-and-the-world/megatrends>].
- Kallionpää, E., Pöllänen, M., Mäkelä, T., Liimatainen, H. 2013. Suomen meriliikenteen skenaariot 2030. Taustaraportti meriliikenteen strategiatyöhön. *Trafin julkaisuja* 3/2013.
- Klanac et al. 2010. Economics and environmental impact of ship speed reduction for Aframax tankers. [http://tkk.academia.edu/AlanKlanac/Papers/313969/ECONOMICS_AND_ENVIRONMENTAL_IMPACT_OF_SHIP_SPEED_REDUCTION_FOR_AFRAMax_TANKERS].
- Levander, Kai. 2011. Design criteria for Baltic cargo vessels. Liikenteen turvallisuusvirasto Trafi.
- Mäkelä, T., Kallionpää, E., Paavilainen, J., Pöllänen, M., Liimatainen, H. 2011. Itämeren kuljetusjärjestelmän tulevaisuuden skenaarioita. Vaikutukset Suomen näkökulmasta. *Trafin julkaisuja* 18/2011.

BSR Policy Briefing 1/2016

Psaraftis et al. 2008. Ship emissions study.

[<http://www.martrans.org/documents/2008/sft/final%20report%20v10.2.pdf>].

Psaraftis et al. 2009. Speed reduction as an emissions reduction measure for fast ships.

[<http://www.martrans.org/documents/2009/air/FAST%202009-Psaraftis%20Kontovas.pdf>].

Rubin, Anita. 2002. Skenaariopolut tulevaisuuteen.

[http://www.futunet.org/fi/materiaalit/metodit/2_metodit/2_skenarix?C:D=347698&selres=347698].

Valli, Raisa. 2011. Hallinnonalojen tulevaisuuskatsaukset liikennejärjestelmän näkökulmasta vuonna 2010.

Tulevaisuuden näkymiä 1/2011, Liikennevirasto.

Wärtsilä. 2010. Shipping scenarios 2030. [<http://www.shippingscenarios.wartsila.com/>].

Earlier publications in the BSR Policy Briefing series

BSR Policy Briefing 1/2015	Natural gas revolution and the Baltic Sea region Edited by Kari Liuhto
BSR Policy Briefing 3/2014	Poland and Russia in the Baltic Sea Region: doomed for the confrontation? Adam Balcer
BSR Policy Briefing 2/2014	Energy security in Kaliningrad and geopolitics. Artur Usanov and Alexander Kharin
BSR Policy Briefing 1/2014	The Baltic Sea region 2014: Ten policy-oriented articles from scholars of the university of Turku. Edited by Kari Liuhto
BSR Policy Briefing 4/2013	The Kaliningrad nuclear power plant project and its regional ramifications. Leszek Jesien and Łukasz Tolak
BSR Policy Briefing 3/2013	Renewable Energy Sources in Finland and Russia - a review. Irina Kirpichnikova and Pekka Sulamaa
BSR Policy Briefing 2/2013	Russia's accession to the WTO: possible impact on competitiveness of domestic companies. Sergey Sutyryn and Olga Trofimenko
BSR Policy Briefing 1/2013	Mare Nostrum from Mare Clausum via Mare Sovieticum to Mare Liberum - The process of security policy in the Baltic. Bo Österlund



CENTRUM
BALTICUM

www.centrumbalticum.org